

Top Loader Washing Machine, 10kg

Series 7 | Top Load

White



With plenty of room for large loads, and 12 wash cycles including Sports, this top loader caters to every type of load.

- 12 wash cycles including Allergy, Sports and Wool
- Includes extra wash feature Soak, for helping cleaning tough stains
- Energy saving with Eco-Active™
- 4 star energy and 3.5 star water rating

DIMENSIONS

Height	1060 - 1090mm
Width	685mm
Depth	700mm

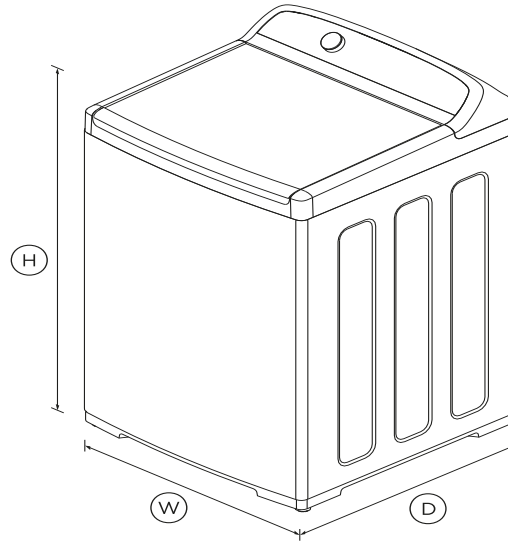

FEATURES & BENEFITS

Easy to use

This machine has a cycle to suit every type of load including Delicate, Sports and Wool. Select a cycle with the easy to use SmartTouch™ control dial.

Soft-Close Lid

The tough glass lid delivers quality and durability. Its soft close mechanism makes it family safe, avoids slamming and allows for hands-free operation.

Cares for clothes

The flexible finned agitator ensures less tangling for superior clothes care.

Eco-Active™ Wash

Eco-Active™ recirculates water and detergent through clothes so less hot water is used to remove stains, dirt and bacteria.

Quicker drying

Drying times are reduced due to a fast spin speed of 1100RPM which helps remove more water.

Large capacity

The 10kg capacity of this washing machine is ideal for larger families and can wash bulky items with ease.

SPECIFICATIONS

Consumption

Energy rating	4 star
Energy usage	345kWh/year
In-use energy carbon	46.7kgCO2e/year
Water consumption per cycle	123L
Water efficiency	3.5 star (WELS)

Features

Adjustable alert beeps	•
Agitator	Flexible finned
Auto out of balance correction	•
Automatic water level	•
Child/Keylock	•
Controlled cold	•
Delay start	•
Detergent dispenser	•
Fabric softener dispenser	•
Lid lock	•
No spin / Spin Hold	•

Rinse options	4	Drum Clean	•
SmartTouch™ control dial	•	Easy Iron	•
Soak	•	Heavy	•
Soil levels	3	Number of wash cycles	12
Spin speeds	3	Quick	•
Stainless steel drum	•	Regular	•
Water temperature controls	5	Rinse	•
		Spin	•
		Sports	•
		Wool	•

Performance

Auto-Lint disposal	•
Load sensing	•
Maximum spin speed	1100rpm
Number of spin speeds	3
SmartDrive™ technology	•

Product dimensions

Depth	700mm
Height	1060 - 1090mm
Height (Lid open)	1420 - 1460mm
Width	685mm

Warranty

Parts and labour	2 years
Parts only SmartDrive™ Motor	10 years

Wash Cycles

Allergy	•
Bulky	•
Conventional	•
Delicate	•

SKU 92266

The product dimensions and specifications in this page apply to the specific product and model. Under our policy of continuous improvement, these dimensions and specifications may change at any time. You should therefore check with Fisher & Paykel's Customer Care Centre to ensure this page correctly describes the model currently available. ? Fisher & Paykel Appliances Ltd 2020

Other product downloads available at fisherpaykel.com

- [↓](#) User Guide
- [↓](#) Energy & Water Label
- [↓](#) Service & Warranty
- [↓](#) Energy & Water Label
- [↓](#) Installation Guide



A PEACE OF MIND SALE

24 Hours 7 Days a Week Customer Support

T 0800 372 273 Wwww.fisherpaykel.com