

## 9kg Series 5 Contemporary Front Loader Washer, Auto Dose



A Front Loader Washer with all the essentials, thoughtfully designed for simple convenience. Refined design and simple controls deliver care that fits seamlessly into everyday life.

- Gentle care for 4 fibre types, including Mixed loads and Wool
- Auto Dose up to 13 washes without refilling
- Intelligent sensors detect load size and adjust water and energy use
- Connect SmartHQ™ for real-time updates, guides and extra functions

### DIMENSIONS

Height	850 mm
Width	602 mm
Depth	593 mm

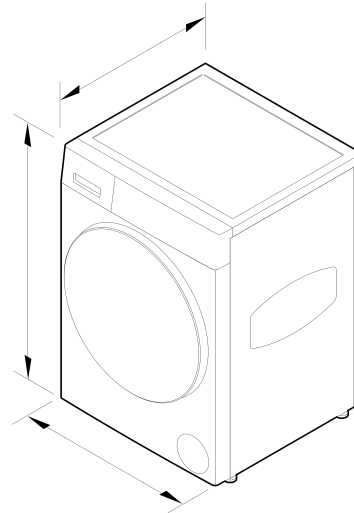

### FEATURES & BENEFITS

#### ESSENTIAL CARE FOR EVERYDAY

Fisher & Paykel Series 5 Washers deliver fabric care you know and trust, now made smarter. From Cotton and Polyester to Woolmark Black certified cycles, intelligent technology automatically adjusts the wash for each fibre type, balancing the perfect clean and gentle care. Options for item type, colour and soil level let you further refine each wash, ensuring optimal care to extend the life of your garments.

#### AUTO DOSE UP TO 13 WASHES

Everyday routines are simpler when the details are taken care of for you. Auto Dose stores enough detergent and softener for up to 13 washes, dispensing the precise amount each time for effortless care. Active Mix blends the detergent with water to reach deep into fibres like Polyester, which can trap odours as it doesn't easily absorb water. With two reservoirs for detergent and softener or specialised formulas, fabric care becomes beautifully simple.

#### REFRESH WITH STEAM

Gently relax fibres to reduce wrinkles and odours with Steam Refresh. Perfect for a Cotton shirt that doesn't need a full wash, steam provides just enough heat and moisture required to loosen the molecular bonds that cause wrinkles, without fully saturating the garment. Steam penetrates the porous structure within the fibre allowing wrinkles to fall away.

#### CLASS-LEADING EFFICIENCY

Designed to reduce running costs and environmental impact with 5-star energy and 4.5-star water ratings, you can trust that your fabric care routine is both effective and sustainable. The SmartDrive™ motor ensures quiet operation and long-lasting reliability, with fewer moving parts for reduced wear over time.

#### WASHING THAT WAITS FOR YOU

Crease Free gives you flexibility to unload laundry when it suits you. Ideal for Cotton which has fibre bonds that temporarily loosen during washing and if left sitting while damp, these bonds can set into creases. By gently tumbling the load after a wash, Crease Free minimises wrinkle causing conditions, keeping fibres smooth and garments looking their best.

#### CLEAN WITH CONFIDENCE

Absorbent items like towels benefit from extra care to stay hygienic and fresh. Sanitise ensures items are thoroughly cleaned, eliminating 99.9% of bacteria\*. The cycle uses hot water to deliver a deep, effective clean, giving you confidence that your fabrics are safe and ready to use. \*Independently certified to eliminate 99.9% of Staphylococcus aureus and Escherichia coli using the Mixed Fibre Type, Moderate Item Type, Sanitise Treatment, Mixed Colour, Moderate Soil Level and Manual Auto Dose settings.

**DESIGNED TO MATCH**

Our most perfect pair yet, reimagined for modern living. Designed to complement one another in both form and function, our Front Loader Washers and Heat Pump Dryers feature refined materials, large doors and complementary cycles that work in harmony to care for every fibre. An angled interface and a newly positioned lint filter on the dryer creates a seamless fabric care experience that's elevated beyond the utility space.

**SPECIFICATIONS**

**Capacity**

Capacity **9 kg**

**Connected Features**

- Alerts and notifications •
- Cyber security updates until **12 / 09 / 2029**
- Education and onboarding •
- Monitoring •
- Remote operation •
- Software updates •

**Consumption**

Energy rating **5 star**  
 Estimated Yearly Energy Usage (kWh) **201kWh/year**  
 Rated capacity (AU NZ only) **9**  
 Water consumption per cycle **77L**  
 Water rating **4.5 star (WELS)**

**Controls**

Interface type **LED touch display**  
 Two button start compliant •

**Features**

- Active Mix •
- Add a garment (immediate door opening) •
- Advanced out of balance detection •
- Anti-Bacteria Treatment (ABT) •
- Anti-fungal door gasket •
- Auto out of balance correction •
- Automatic water level •
- Child/Keylock •
- Controlled cold •
- Crease Free •
- Delay start •
- Detergent dispenser **Auto Dose**
- Excess suds detection •
- Extra large door •
- Extra Rinse **via SmartHQ app**
- Fabric softener dispenser **Auto Dose**
- Favourite mode **Multiple**

- Flood protection •
- Front and back levelling feet •
- Interior light •
- Optimise Wash **via SmartHQ app**
- Pre Wash Cold **via SmartHQ app**
- Quiet mode **via SmartHQ app**
- Reverse tumbling **Full reverse tumbling**
- Smart appliance •
- Soak **via SmartHQ app**
- Stainless steel drum •
- Time saver function •
- Time to go •
- Water supply **Cold**
- Woolmark certified **Woolmark Black**

**Performance**

- Auto load sensing •
- Maximum spin speed **1400 rpm**
- Motor type **Direct Drive**
- Number of spin speeds **4**
- SmartDrive™ technology •
- Vortex wash •

**Product dimensions**

Depth **593 mm**  
 Height **850 mm**  
 Width **602 mm**

SKU

92304



**A PEACE OF MIND SALE**  
24 Hours 7 Days a Week Customer Support  
T 1300 650 590 W [www.fisherpaykel.com](http://www.fisherpaykel.com)

The product dimensions and specifications in this page apply to the specific product and model. Under our policy of continuous improvement, these dimensions and specifications may change at any time. You should therefore check with Fisher & Paykel's Customer Care Centre to ensure this page correctly describes the model currently available. © Fisher & Paykel Appliances Ltd 2020

#### Other product downloads available at [fisherpaykel.com](http://fisherpaykel.com)

- [↓](#) Energy Label
- [↓](#) Installation Guide - Side by Side (English)
- [↓](#) Installation Guide - Stacked (English)
- [↓](#) Installation Guide (English)
- [↓](#) Planning Guide (English)
- [↓](#) Revit
- [↓](#) Introducing Fabric Care Solutions (English)
- [↓](#) User Guide (English)

#### Where applicable:

All appliances use energy, and energy usage typically generates carbon emissions. **Fisher & Paykel Appliances' In-use Energy Carbon Emissions Estimate** indicates carbon emissions from a product's in-use energy. This is calculated either annually or per cycle, using the product's market-specific energy label energy consumption data multiplied by the carbon emissions factor for energy in your country or region.

Our In-use Energy Carbon Emissions Estimate is designed to assist customers in making informed purchasing decisions when comparing different Fisher & Paykel products. For example, a heat pump dryer typically has a lower In-use Energy Carbon Emissions Estimate than a vented dryer.