

INTEGRATED REFRIGERATOR FREEZER, 36", ICE & WATER

PLANNING GUIDE

RS3684WRUVK5 | RS3684WLUVK5

FISHER & PAYKEL

This comprehensive Planning Guide provides you with the framework and tools to achieve your desired design outcome with Fisher & Paykel appliances. In this guide, you will find a range of conceptual, detailed, and dimensional product information to bring your ideas to life and create spaces that truly reflect your vision.

CONTENTS

CONCEPT DESIGN	PAGE	DEVELOPED AND DETAILED DESIGN	PAGE	DEVELOPED AND DETAILED DESIGN	PAGE
Specification Guide					
Specification Guide - Refrigerator Freezer 36"	4	Planning Guide information for Developed and Detailed Design available in Q3 2024			
Platform Overview					
Platform Overview - Integrated Columns	7				
Design Choices - Integrated Columns	8				
Accessories Overview - Door Panels, Handles	9				
Accessories Overview - Toe Kicks, Joiner Kits	10				

SPECIFICATION GUIDE



RS3684WLUVK5 - with Stainless Steel Door Panel



RS3684WRUVK5 - with Custom Door Panel

OVERVIEW

Designed to fit flush with cabinetry with minimal 1/8 inch gaps, this Integrated Refrigerator can be installed individually or paired with other Integrated models. For true design freedom, it can be installed with stainless steel or custom door panels. ActiveSmart™ Foodcare helps keep food fresher for longer, while the Variable Temperature Drawer can be adjusted to Chill, Fridge, or Pantry modes, to suit different types of food.

PRODUCTS

RS3684WRUVK5 Integrated Refrigerator Freezer, 36", Ice & Water, Right Hand Hinge
(All models can achieve opposite hinge location using the supplied parts)

RS3684WLUVK5 Integrated Refrigerator Freezer, 36", Ice & Water, Left Hand Hinge
(All models can achieve opposite hinge location using the supplied parts)

SERIES

Series 11

FEATURES

- ① Fits with stainless steel or custom door panels
- ② Independent Variable Temperature Drawer can change between Chill, Fridge, or Pantry modes to suit different foods
- ③ Flush fit with 1/8 inch gaps and custom height installation
- ④ Automatic ice maker and internal water dispenser
- ⑤ ActiveSmart™ Foodcare helps keep food fresher for longer
- ⑥ Easy to use touch-control panel and WiFi capability
- ⑦ LED-lit and adjustable cantilevered shelving
- ⑧ Stainless steel interior lining with robust hinges
- ⑨ Perfectly pairs with other integrated models for flexible configurations

The models shown in this Planning Guide may not be available in all markets and are subject to change at any time. Product specifications may vary from those shown. This Planning Guide should not be used as installation guidance for any product. Further information is required to safely and correctly install the products featured here. Specific installation guidance will be available on our website fisherpaykel.com

SPECIFICATIONS

Model No.	RS3684WRUVK5, RS3684WLUVK5
Product Dimensions	H 84" W 35 3/4" D 24"
Electrical	
Supply	115 V, 60 Hz
Service	10 A

PRODUCT DIMENSIONS

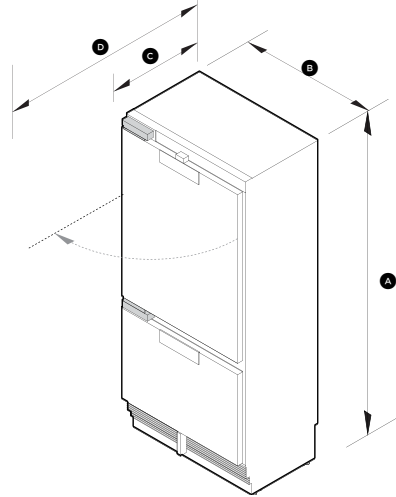

	inch	mm
Ⓐ Overall height	84	2134
Ⓑ Overall width	35 3/4	908
Ⓒ Overall depth*	24	610
Ⓓ Overall depth with the door open*	61 13/16	1570
Ⓔ Overall depth with drawer open*	39 1/2	1004
Height from floor to bottom of bottom door panel**	19/32 - 5 29/32	15-150
Depth of toe kick (excl. front door and toe kick panels)**	1 31/32 - 3 15/16	50-100

*Excluding handle and door panel
 **Applies to custom door panels

CAVITY DIMENSIONS: STANDARD INSTALLATION

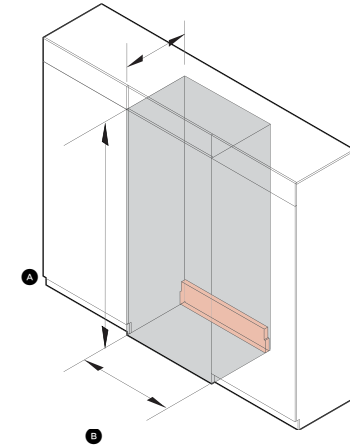



	inch	mm
Ⓐ Height	84	2134
Ⓑ Minimum width	36	914
Ⓒ Minimum overall cavity depth with service to the side*	25	635

Service area H 9 1/32" x W 36" x D 31/32"

*Assumes a door panel thickness of 3/4"

The models shown in this Planning Guide may not be available in all markets and are subject to change at any time. Product specifications may vary from those shown. This Planning Guide should not be used as installation guidance for any product. Further information is required to safely and correctly install the products featured here. Specific installation guidance will be available on our website fisherpaykel.com

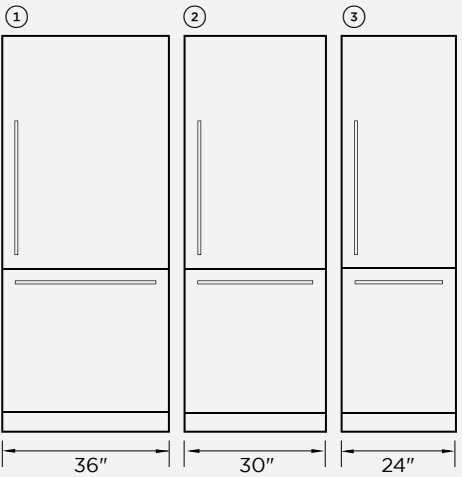
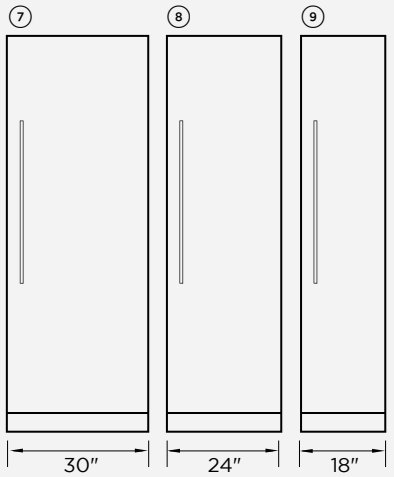
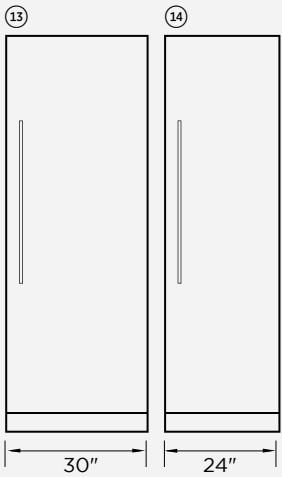
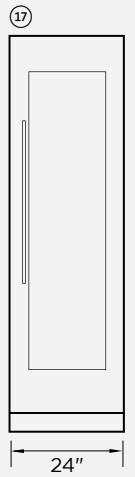
PLATFORM OVERVIEW

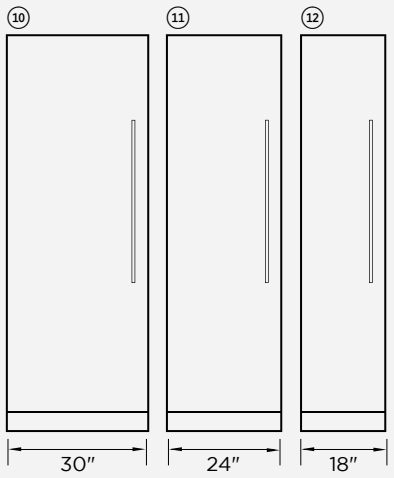
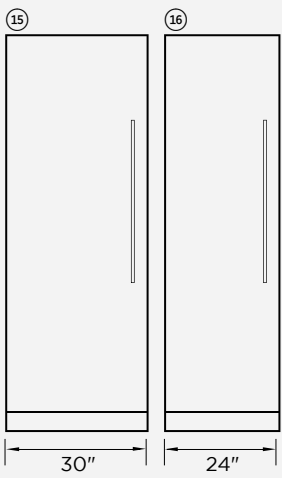
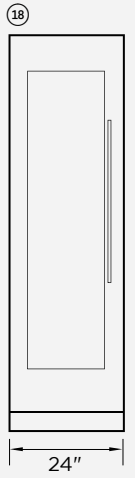
REFRIGERATOR/FREEZER	FREEZER	REFRIGERATOR	WINE	REFRIGERATOR/FREEZER
<p>RIGHT HINGE</p>  <p>① 36" ② 30" ③ 24"</p>	<p>RIGHT HINGE</p>  <p>⑦ 30" ⑧ 24" ⑨ 18"</p>	<p>RIGHT HINGE</p>  <p>⑬ 30" ⑭ 24"</p>	<p>RIGHT HINGE</p>  <p>⑰ 24"</p>	<p>REFRIGERATOR/FREEZER</p> <ul style="list-style-type: none"> ① RS3684WRUVK ② RS3084WRUK ③ RS2484WRUK ④ RS3684WLUVK ⑤ RS3084WLUK ⑥ RS2484WLUK
<p>LEFT HINGE</p>  <p>④ 36" ⑤ 30" ⑥ 24"</p>	<p>LEFT HINGE</p>  <p>⑩ 30" ⑪ 24" ⑫ 18"</p>	<p>LEFT HINGE</p>  <p>⑮ 30" ⑯ 24"</p>	<p>LEFT HINGE</p>  <p>⑱ 24"</p>	<p>FREEZER</p> <ul style="list-style-type: none"> ⑦ RS3084FRJK ⑧ RS2484FRJK ⑨ RS1884FRJK ⑩ RS3084FLJK ⑪ RS2484FLJK ⑫ RS1884FLJK
				<p>REFRIGERATOR</p> <ul style="list-style-type: none"> ⑬ RS3084SRHK*/ RS3084SRK ⑭ RS2484SRHK*/ RS2484SRK ⑮ RS3084SLHK*/ RS3084SLK ⑯ RS2484SLHK*/ RS2484SLK <p>*Model with internal water</p> <p>WINE</p> <ul style="list-style-type: none"> ⑰ RS2484VR2K ⑱ RS2484VL2K <p>Any model can be installed adjacent to one another</p>

All models can be installed side by side but hinge consideration is advised
 All models have stainless steel door panels, handles, toe kicks and joiner kits accessories available

①
MODELS

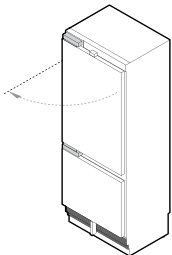

Single Installation

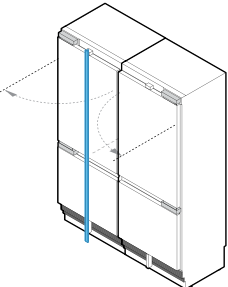

Dual Installation

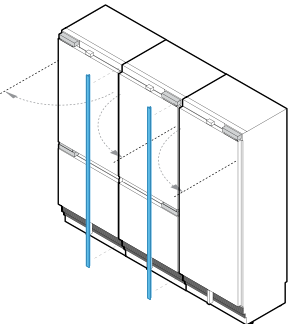

Triple Installation



②
DOOR STYLE

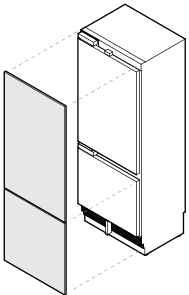

Stainless Steel Panels

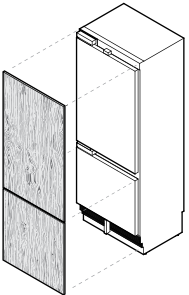

Custom Door Panels

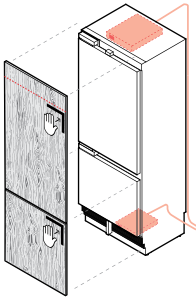

Custom Door Panels and Assisted Opening Accessory



③
HANDLES

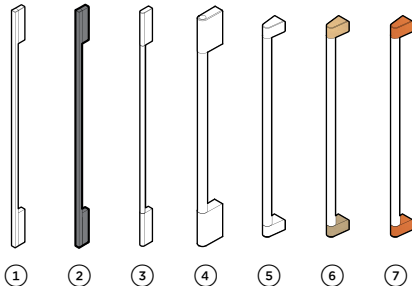

Accessory Handles



Custom Handle



No handle



④
TOE KICK

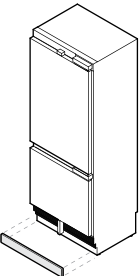

Stainless Steel Toe Kick

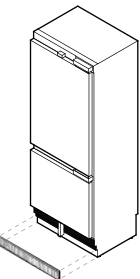

Custom Toe Kick

ACCESSORIES OVERVIEW | INTEGRATED COLUMNS

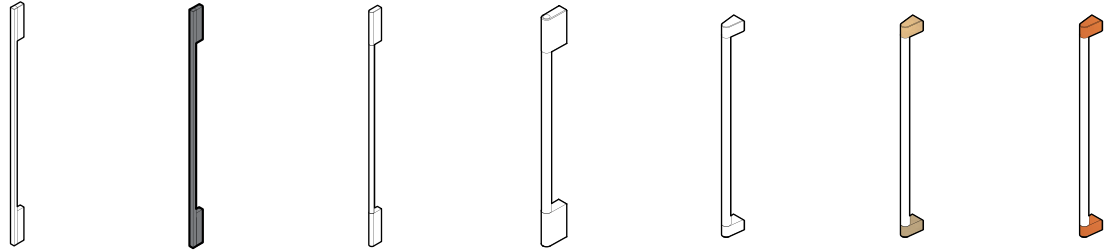
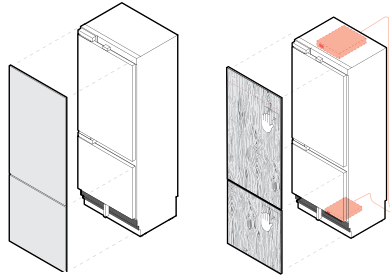

MODELS	STAINLESS STEEL DOOR PANEL	ASSISTED OPENING ACCESSORIES <small>available TBC</small>	① HANDLE SQUARE FINE	② HANDLE SQUARE FINE BLACK	② HANDLE ROUND	④ HANDLE CLASSIC	⑤ HANDLE PROFESSIONAL STAINLESS	⑥ HANDLE PROFESSIONAL BRASS	⑦ HANDLE PROFESSIONAL DARK COPPER
REFRIGERATOR/FREEZER									
① RS3684WRUVK - 36" - Right Hinge	RDW3684WRD	OPINEXIRSW	AHD5RD3684W	AHD5RD3684WB	AHSRD3684W	AHCLRD3684W	AHP3RD3684W	AHP3RD3684WBA	AHP3RD3684WDC
② RS3084WRUK - 30" - Right Hinge	RDW3084WRD	OPINEXIRSW	AHD5RD3084W	AHD5RD3084WB	AHSRD3084W	AHCLRD3084W	AHP3RD3084W	AHP3RD3084WBA	AHP3RD3084WDC
③ RS2484WRUK - 24" - Right Hinge	RDW2484WRD	OPINEXIRSW	AHD5RD2484W	AHD5RD2484WB	AHSRD2484W	AHCLRD2484W	AHP3RD2484W	AHP3RD2484WBA	AHP3RD2484WDC
④ RS3684WLUVK - 36" - Left Hinge	RDW3684WLD	OPINEXIRSW	AHD5RD3684W	AHD5RD3684WB	AHSRD3684W	AHCLRD3684W	AHP3RD3684W	AHP3RD3684WBA	AHP3RD3684WDC
⑤ RS3084WLUK - 30" - Left Hinge	RDW3084WLD	OPINEXIRSW	AHD5RD3084W	AHD5RD3084WB	AHSRD3084W	AHCLRD3084W	AHP3RD3084W	AHP3RD3084WBA	AHP3RD3084WDC
⑥ RS2484WLUK - 24" - Left Hinge	RDW2484WLD	OPINEXIRSW	AHD5RD2484W	AHD5RD2484WB	AHSRD2484W	AHCLRD2484W	AHP3RD2484W	AHP3RD2484WBA	AHP3RD2484WDC
FREEZER									
⑦ RS3084FRJK - 30" - Right Hinge	RD3084R4D	OPEX1	AHD5RDSF	AHD5RDSFB	AHSRDSF	AHCLRDSF	AHP3RDSF	AHP3RDSFBA	AHP3RDSFDC
⑧ RS2484FRJK - 24" - Right Hinge	RD2484R4D	OPEX1	AHD5RDSF	AHD5RDSFB	AHSRDSF	AHCLRDSF	AHP3RDSF	AHP3RDSFBA	AHP3RDSFDC
⑨ RS1884FRJK - 18" - Right Hinge	RD1884R4D	OPEX1	AHD5RDSF	AHD5RDSFB	AHSRDSF	AHCLRDSF	AHP3RDSF	AHP3RDSFBA	AHP3RDSFDC
⑩ RS3084FLJK - 30" - Left Hinge	RD3084L4D	OPEX1	AHD5RDSF	AHD5RDSFB	AHSRDSF	AHCLRDSF	AHP3RDSF	AHP3RDSFBA	AHP3RDSFDC
⑪ RS2484FLJK - 24" - Left Hinge	RD2484L4D	OPEX1	AHD5RDSF	AHD5RDSFB	AHSRDSF	AHCLRDSF	AHP3RDSF	AHP3RDSFBA	AHP3RDSFDC
⑫ RS1884FLJK - 18" - Left Hinge	RD1884L4D	OPEX1	AHD5RDSF	AHD5RDSFB	AHSRDSF	AHCLRDSF	AHP3RDSF	AHP3RDSFBA	AHP3RDSFDC
REFRIGERATOR									
⑬ RS3084SRHK/RS3084SRK - 30" - Right Hinge	RD3084R4D	OPEX1	AHD5RDSF	AHD5RDSFB	AHSRDSF	AHCLRDSF	AHP3RDSF	AHP3RDSFBA	AHP3RDSFDC
⑭ RS2484SRHK/RS2484SRK - 24" - Right Hinge	RD2484R4D	OPEX1	AHD5RDSF	AHD5RDSFB	AHSRDSF	AHCLRDSF	AHP3RDSF	AHP3RDSFBA	AHP3RDSFDC
⑮ RS3084SLHK/RS3084SLK - 30" - Left Hinge	RD3084L4D	OPEX1	AHD5RDSF	AHD5RDSFB	AHSRDSF	AHCLRDSF	AHP3RDSF	AHP3RDSFBA	AHP3RDSFDC
⑯ RS2484SLHK/RS2484SLK - 24" - Left Hinge	RD2484L4D	OPEX1	AHD5RDSF	AHD5RDSFB	AHSRDSF	AHCLRDSF	AHP3RDSF	AHP3RDSFBA	AHP3RDSFDC
WINE									
⑰ RS2484VR2K - 24" - Right Hinge	RD2484VR4	OPEX1	AHD5RDSF	AHD5RDSFB	AHSRDSF	AHCLRDSF	AHP3RDSF	AHP3RDSFBA	AHP3RDSFDC
⑱ RS2484VL2K - 24" - Left Hinge	RD2484VL4	OPEX1	AHD5RDSF	AHD5RDSFB	AHSRDSF	AHCLRDSF	AHP3RDSF	AHP3RDSFBA	AHP3RDSFDC

Custom door panels and toe kicks to be manufactured by joiner/cabinetmaker

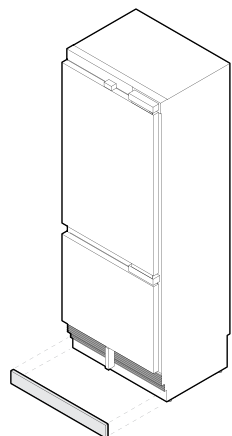

Single installation
No Joiner Kit required

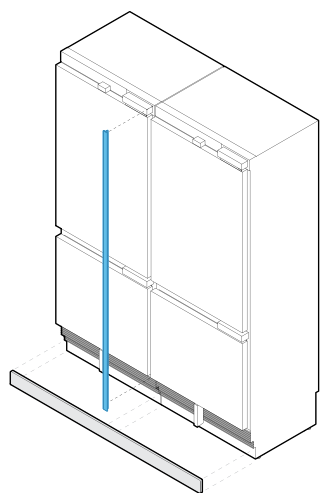

Dual installation
1x Joiner Kit required

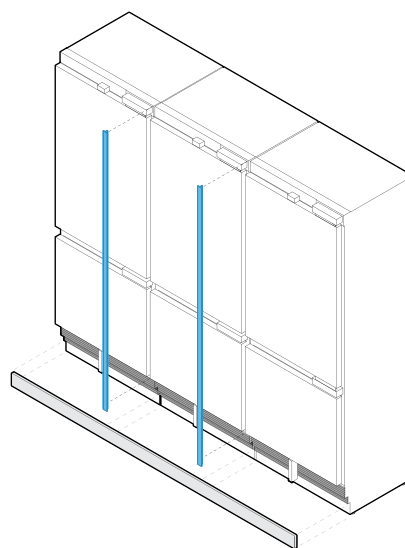

Triple installation
2x Joiner Kits required

JOINER KIT INFORMATION

1x Joiner Kit (AJ-RS84LR) supplied with the following Freezer and Wine Models.

FREEZER

RS3084FRJK, RS3084FLJK

RS2484FRJK, RS2484FLJK

RS1884FRJK, RS1884FLJK

WINE

RS2484VR2K, RS2484VL2K

Additional Joiner Kits, AJ-RS84LR available

No Joiner Kit supplied with the following Refrigeration/Freezer and Refrigerator Models.

REFRIGERATOR/FREEZER

RS3684WRUVK, RS3684WLUVK

RS3084WRUK, RS3084WLUK

RS2484WRUK, RS2484WLUK

REFRIGERATOR

RS3084SRHK, RS3084SLHK, RS3084SRK, RS3084SLK

RS2484SRHK, RS2484SLHK, RS2484SRK, RS2484SLK

Additional Joiner Kits, AJ-RS84LR available

STAINLESS STEEL TOE KICK

SINGLE INSTALLATION

All 18" models	AKRS1804
All 24" models	AKRS2404
All 30" models	AKRS3004
All 36" models	AKRS3604

DUAL INSTALLATION

18" + 24"	AKRS4204
18" + 30"	AKRS4804
18" + 36"	AKRS5404
24" + 24"	AKRS4804
24" + 30"	AKRS5404
24" + 36"	AKRS6004
30" + 30"	AKRS6004
30" + 36"	AKRS6604
36" + 36"	AKRS7204

TRIPLE INSTALLATION

18" + 24" + 24"	AKRS6604
24" + 24" + 24"	AKRS7204
30" + 24" + 24"	AKRS7804
30" + 30" + 24"	AKRS8404

