

Built-in Dishwasher, Tall, Sanitize

Series 9 | Contemporary

Stainless Steel



Offering a superior wash performance and advanced drying, this dishwasher is designed to fit flush under your benchtop for a seamless look.

- Designed to be built under your benchtop, fitting flush with cabinetry for a seamless look
- Eight wash programs from Heavy to Light, including Auto, 60min and Glassware
- Dry+, Sanitize, Half Load and Intensive modifiers provide extra wash options

- Wi-Fi enabled and works with the SmartHQ™ app for remote control and notifications

DIMENSIONS

Height	33 3/4 - 36 1/8"
Width	23 1/2"
Depth	22 5/8"

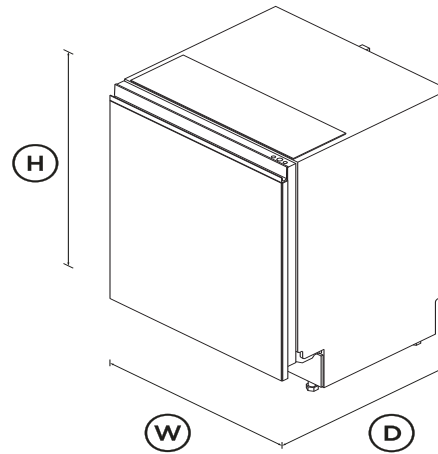

FEATURES & BENEFITS

Seamless Design

Install this dishwasher flush under your benchtop with minimal gaps. Designed to match our Contemporary family of appliances with a recessed handle for a seamless finish in your kitchen.

Advanced drying

For beautifully dry dishes every time, this dishwasher features an

advanced drying system. It combines fan-assisted drying with an automatic door opening at the cycle's end. The Auto Door Open Dry feature releases excess steam, ensuring dishes are immediately ready for use or storage. An innovative air curtain channels the steam away from the adjacent benchtop, protecting your cabinetry.

An Exceptional Clean

This dishwasher offers eight wash programs including Glassware and Auto, which automatically senses the optimal wash settings for your dishes. The three-stage filtration system delivers a superior clean, while the rinse aid indicator reminds you to top up for beautifully clean dishes.

Customize Your Wash

Create the perfect wash with our range of modifiers, from Intensive for a thorough clean to Half Load, ideal for a partial load. The Sanitize modifier provides extra protection, killing 99.9% of bacteria* in the final rinse, while Dry+ is great for plastic dishes. *Certified to NSF/ANSI Standard 184

Quiet Performer

Running at a very low decibel rating, this dishwasher does its job without making a fuss. The combination of clever technology and simple mechanics means greater reliability and superior wash performance, with minimal noise.

Efficient Performance

With an Energy Star Most Efficient rating, this dishwasher is recognised as among the most energy efficient models on the market. Use the Eco wash program for optimal water and energy consumption, or choose when the cycle begins with Delay Start.

Flexible Loading

Designed to fit 15 place settings, this spacious model lets you stack large items with ease. Adjustable rack options provide flexibility for any load, with a full-width cutlery tray, height-adjustable middle rack, cup holders and wine glass supports.

SPECIFICATIONS

Accessories

Cutlery basket	•
Kickstrip	•

Accessories (sold separately)

Handle kit Contemporary	AHD5-OBDD-60SB
-------------------------	-----------------------

Capacity and loading

Accommodates round plates	12 9/16"
Accommodates round plates	9 13/16"
Adjustable height, foldable	•
Easy lift adjustable upper	•
Fold down tines	•
Full width cutlery/utensil tray	•
Large crockery insert in lower	•
Place settings	15
Telescopic slides	•
Wine glass supports with	•

Consumption

Energy rating	Energy star Most efficient
Energy usage	210kWh/year
In-use energy carbon	77.0kgCO2e/year
Water usage (per wash cycle)	3.2 gal

Controls

Energy saving delay start	•
Floor light cycle feedback	•
Internal light	•
Internal wash selector	•

Intuitive capacitive touch	•
Keylock	•
Rinse aid indicator light	•
Wi-Fi connectivity	•

Features

Air curtain for bench	•
Auto Door Open Dry	•
Fan assisted drying	•
Flood protection	•
Fully independent spray arms	•
Half load option	•
Internal tub material	Stainless Steel
Motor type	BLDC
Variable wash pressure	•

Performance

Noise emissions	42dBA
-----------------	--------------

Power requirements

Amperage	10A
Supply frequency	50Hz
Supply voltage	100 - 120V

Product dimensions

Depth	22 5/8"
Height	33 3/4 - 36 1/8"
Width	23 1/2"

Warranty

Parts and labor	Limited 2 years
-----------------	------------------------

Wash Program Modifiers

Dry +	•
Half-load	•
Intensive	•
Sanitize	•
Wash modifiers	4

Wash Programs

60 min	•
Auto	•
Eco	•
Glassware	•
Heavy	•
Light	•
Medium	•
Rinse	•
Wash programs	8

Water connection

Water pressure	30kPa - 1000 kPa
----------------	-------------------------

SKU	82444
-----	--------------









The product dimensions and specifications in this page apply to the specific product and model. Under our policy of continuous improvement, these dimensions and specifications may change at any time. You should therefore check with Fisher & Paykel's Customer Care Centre to ensure this page correctly describes the model currently available. Fisher & Paykel Appliances Ltd 2020

Where applicable:

All appliances use energy, and energy usage typically generates carbon emissions. **Fisher & Paykel Appliances' In-use Energy Carbon Emissions Estimate** indicates carbon emissions from a product's in-use energy. This is calculated either annually or per cycle, using the product's market-specific energy label energy consumption data multiplied by the carbon emissions factor for energy in your country or region.

Our In-use Energy Carbon Emissions Estimate is designed to assist customers in making informed purchasing decisions when comparing different Fisher & Paykel products. For example, a heat pump dryer typically has a lower In-use Energy Carbon Emissions Estimate than a vented dryer.

Other product downloads available at fisherpaykel.com

-  [Service & Warranty](#)
-  [Guide d'utilisation FR](#)
-  [User Guide Dishwasher](#)
-  [Energy Label Dishwasher](#)
-  [Guide d'installation FR](#)
-  [Installation Guide Built-in Dishwasher](#)
-  [Preliminary Specification Guide Dishwasher](#)
-  [Data Sheet Dishwasher](#)

**A PEACE OF MIND SALE****24 Hours 7 Days a Week Customer Support****T 1.888.936.7872 W www.fisherpaykel.com**