

Integrated Column Freezer, 30", Ice

Series 9 | Integrated

Panel Ready | Left hinge



Install it separately or pair with another Column for seamless integration – this model is left hinge with brushed steel interior.

- ActiveSmart™ technology helps keep food fresher for longer by constantly maintaining the ideal temperature
- Two separate Variable Temperature Zones: each with Freeze, Soft Freeze or Deep Freeze
- Internal ice maker with boost for busy times
- Customize with your own kitchen cabinetry or purchase our stainless steel door panel accessory

DIMENSIONS

Height	84 "
Width	29 ³ / ₄ "
Depth	24 "

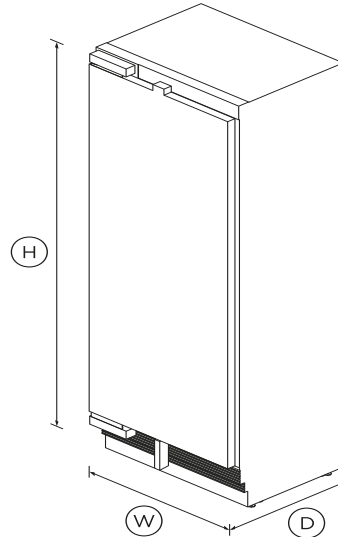

FEATURES & BENEFITS

Variable Temperature Zones

Food is stored in two separate zones. You have the choice of three food modes: Freeze -7°F to 7°F, Soft Freeze 14°F to 18°F and Deep Freeze is fixed at -13°F.

Mix & match

Integrated Column Refrigeration gives you the freedom to mix and match. Different sized Column Fridges and Freezers can be installed separately or paired. Finish them with our stainless steel door panels or customize to match your own kitchen cabinetry.

Clever energy

Our Energy Star certified ActiveSmart™ Foodcare Fridges & Freezers adapt to daily use by cooling and defrosting only when needed. This means your refrigerator uses the energy it needs without compromising on food care.

Appealing illumination

Bright LEDs light up the ceiling, shelves, bins and tray in both refrigerator and freezer, making it easy to find your food and creating a welcoming glow in your kitchen for those midnight snacks.

Design quality

The premium design and quality finish includes a steel interior lining as well as full extension metal shelf runners for easy access and robust glass shelving.

Easy install

Integrated Column Refrigerators and Freezers have been developed to make their installation easy. The joiner kit is included when pairing refrigerator and freezers. All models come with front adjustable levelling feet and they've been designed to easily slide into place as separate units.

Perfect fit

These models fit flush and have only 1/8" / 3mm gaps around them with no visible hinges or grilles. Our Integrated Column models can be seamlessly hidden behind your cabinetry or you can purchase our stainless steel door panel.

SPECIFICATIONS

Accessories (sold separately)

30" Stainless steel toe kick	25392
48" Stainless steel toe kick	25396
54" Stainless steel toe kick	25398
60" Stainless steel toe kick	25400
Contemporary round handle	24981

Contemporary square handle	24979
Joiner kit	24985
Matching Replacement Water	847200
Professional round handle kit	24980
Professional square handle kit	24982
Stainless steel door panel	24972

Consumption

Energy rating	491
Energy star rating	Yes
Energy usage	491kWh/year

Freezer features

Automatic ice maker	•
Bottle chill	•
Door alarm	•
Fast freeze	•
Freezer bins	4
Ice Boost	•
LED bin lighting	•
LED ceiling lighting	•
LED side lighting	•
SmartTouch interface at	•

Performance

ActiveSmart™ Foodcare	•
ActiveSmart™ technology	•
Adaptive defrost	•
Dual evaporator	•
Frost free	•

Frost free freezer	•
Inverter controlled compressor	•
Sabbath mode	•
Variable food modes	Soft freeze; Freeze; Deep

Power Requirements

Rated current	10A
Supply frequency	60Hz
Supply voltage	115V

Product dimensions

Depth	24 "
Depth (less door)	24 "
Height	84 "
Width	29 ³/₄ "

Refrigerator features

Adjustable door shelves	4
Adjustable glass cantilevered	3

Warranty

Parts and labor	2 years
Sealed system parts only	5 years

SKU	25592
-----	--------------

TEST The product dimensions and specifications in this page apply to the specific product and model. Under our policy of continuous improvement, these dimensions and specifications may change at any time. You should therefore check with Fisher

& Paykel's Customer Care Centre to ensure this page correctly describes the model currently available. ? Fisher & Paykel Appliances Ltd 2020

Other product downloads available at fisherpaykel.com

- [↓](#) User Guide
- [↓](#) Service & Warranty Booklet
- [↓](#) Guide D'Utilisation
- [↓](#) Energy Label
- [↓](#) Installation Guide
- [↓](#) Guide D'Installation
- [↓](#) Resources (zip)



A PEACE OF MIND SALE

24 Hours 7 Days a Week Customer Support

T 1.888.936.7872 W www.fisherpaykel.com