

Series 7, Contemporary Single DishDrawer Dishwasher

Contemporary



A compact size to fit anywhere, room to wash a half load, and less bending.

- Six wash programs to suit any load, from Delicate to Heavy
- American Disabilities Act (ADA) compliant, this can be installed at an accessible height for loading and unloading.

DIMENSIONS

Height 16 1/8 "

Width 23 9/16 "
Depth 22 9/16 "

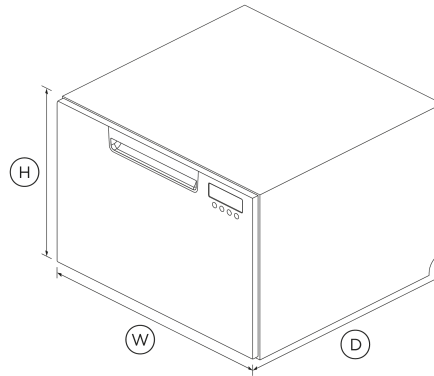

FEATURES & BENEFITS

Ease of use

DishDrawer™ Dishwashers are as easy to open and close as kitchen drawers and can be conveniently positioned at bench height for ease of loading and minimal bending.

Flexible wash options

DishDrawer™ Dishwashers feature many programs including: Rinse, Fast, Delicate, Normal Eco, Normal and Heavy. These options allow the DishDrawer™ to wash everything from fine glass and crystal to heavily soiled pots and pans at the touch of a button.

Complementary Design

DishDrawer™ Dishwashers can be installed in any kitchen space and are designed to match the Fisher & Paykel family of kitchen appliances, with matching handles, premium styling and quality materials.

Quiet performer

Running at a very low decibel rate, these DishDrawer™ Dishwashers do their job without making a fuss. The combination of intelligent technology and simple mechanics means greater reliability and excellent wash performance.

SPECIFICATIONS

Accessories (included)

- Cutlery basket

Capacity and loading

Accommodates round plates up to	11"
Fixed height, foldable cupracks	•
Fold down tines	•
Place settings	7
Place settings	7

Connected Features

- Alerts and notifications
- Education and onboarding
- Monitoring
- Software updates

Consumption

Energy rating	Energy Star
Energy usage	151kWh/year
In-use energy carbon emissions estimate	17.4kgCO2e/year
Water usage (per wash cycle)	1.81 gal

Rated current	15 A
Supply frequency	60Hz
Supply voltage	100 - 120V

SKU **82333**

The product dimensions and specifications in this page apply to the specific product and model. Under our policy of continuous improvement, these dimensions and specifications may change at any time. You should therefore check with Fisher & Paykel's Customer Care Centre to ensure this page correctly describes the model currently available. © Fisher & Paykel Appliances Ltd 2020

Controls

Electronic fault/Diagnostic indicator	•
End of cycle beeps	•
Energy saving delay start option of up to 12 hours	•
Keylock	•
Rinse aid indicator light	•
Smart appliance	•

Product dimensions

Depth	22 9/16 "
Height	16 1/8 "
Width	23 9/16 "

Other product downloads available at fisherpaykel.com

- [↓](#) DXF
- [↓](#) Data Sheet (English)
- [↓](#) DWG
- [↓](#) Energy Label (English, Canadian French)
- [↓](#) Installation Guide (English)
- [↓](#) Installation Guide (Canadian French)
- [↓](#) Installation Guide (Spanish)
- [↓](#) California Warning Proposition 65 (English, Spanish, Canadian French, Chinese)
- [↓](#) Revit
- [↓](#) Rhino
- [↓](#) Right To Repair Declaration (English, Canadian French)
- [↓](#) SketchUp
- [↓](#) User Guide (English, Canadian French)
- [↓](#) Installation Video

Features

Fan assisted drying	•
Flood protection	•
Flow through detergent dispenser	•
Motor type	BLDC
Quiet operation	•
SmartDrive™ technology	•

Safety and compliance

ADA compliant	•
---------------	---

Wash Programs

Delicate	•
Eco	•
Fast	•
Heavy	•
Medium	•
Rinse	•
Wash programs	6

Performance

Noise emissions	43 dBA
-----------------	---------------

Water connection

Water pressure	30kPa - 1000 kPa
Water supply	3/8" to suit Male Compression Fitting

Where applicable:

Power requirements

Amperage	5A
Electric circuit	3

All appliances use energy, and energy usage typically generates carbon emissions. **Fisher & Paykel Appliances' In-use Energy Carbon Emissions Estimate** indicates carbon emissions from a product's in-use energy. This is calculated either annually or per cycle, using the product's market-specific energy label energy consumption data multiplied by the carbon emissions factor for energy in your country or region.

Our In-use Energy Carbon Emissions Estimate is designed to assist customers in making informed purchasing decisions when comparing different Fisher & Paykel products. For example, a heat pump dryer typically has a lower In-use Energy Carbon Emissions Estimate than a vented dryer.



A PEACE OF MIND SALE
24 Hours 7 Days a Week Customer Support
T 1.888.936.7872 W www.fisherpaykel.com