

36" Series 7 Classic 5 Burner Gas Range

Classic



Make your range a focal point. With a large capacity oven and five burners, this is the perfect way to cook for a crowd.

- Five burner gas cooktop, including one dual ring and two triple ring wok burners
- Gas oven with 4.9 cu ft total capacity and three functions including Bake and Broil

DIMENSIONS

Height	35 3/4 - 37 1/4 "
Width	35 7/8 "

Depth

25 1/4 "

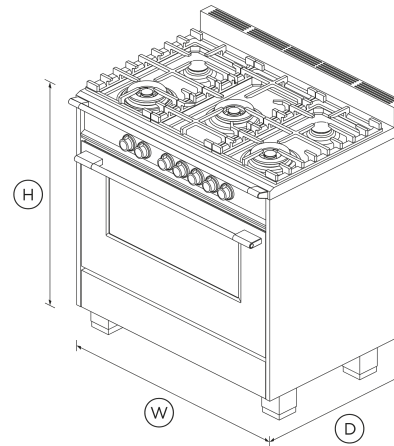

FEATURES & BENEFITS

Design Quality

This range has been carefully crafted in every detail from performance to durability using quality materials including the balanced soft-close door and rounded rangetop rail.

Large Capacity Oven

The generous 4.9 cu.ft total capacity oven gives you plenty of space to cook multiple dishes at once, with enough room to fit a 32 lb turkey.

Performance Power

Precise cooktop controls let you sear or stir fry over instant, powerful heat. Use the high burner power or simmer a delicate sauce using the gentlest of heats.

Easy cleaning

With its durable surface, your cooktop simply needs a quick wipe after cooking to keep it looking good as new for years to come.

SPECIFICATIONS

Accessories (included)

2-pc grill system (Broil pan and Grill rack)	•
Broil pan	•
Chromed shelf runners	1 set
Full extension telescopic shelves	2 sets (part 578744)
Grill rack	TRUE
Small pot support	1 (part 533981 cast)

Accessories (sold separately)

Kick strip, black (optional)	KICKOR36B1
Kick strip, red (optional)	KICKOR36R1
Kick strip, stainless steel (optional)	KICKOR36X1
Kick strip, white (optional)	KICKOR36W1
Wok grate included	Yes

Burner ratings

Dual wok burner inner/outer (LPG)	1000 - 18000BTU
Dual wok burner inner/outer (natural gas)	1000 - 18000BTU
Maximum burner power	18000 BTU
Semi-rapid burner (LPG)	7600BTU
Semi-rapid burner (natural gas)	8000BTU
Total cooktop power	62000 BTU

Triple ring wok burner (LPG) x2	6100 - 12000BTU
Triple ring wok burner (natural gas) x2	6100 - 14000BTU

Capacity

Shelf positions	7
-----------------	----------

Cleaning

- Acid resistant graphite enamel
- Removable oven door
- Removable shelf runners

Controls

- Laser etched graphics

Gas Requirements

Supply Pressure (LPG)	11" W.C.P
Supply Pressure (natural gas)	4" W.C.P

Oven features

- Auto re-ignition system
- Concealed element
- Convection
- Electronic ignition
- Full extension telescopic sliding shelves
- Soft open/close door
- Storage drawer

Oven functions

Bake	•
Broil	•
Convection bake	•
Number of functions	3

Oven performance

Bake power	17000 BTU
Broil	13000 BTU
CoolTouch door	Quadruple glazed

Power Requirements

Amperage	15 A
Supply frequency	60 Hz
Supply voltage	120 V

Product Dimensions

Depth	25 1/4 "
Height	35 3/4 - 37 1/4 "
Width	35 7/8 "

Rangetop features

- Hob rail
- LPG / Natural Gas compatible
- Sealed range top

Safety

- ADA compliant
- Advanced cooling system
- Anti-tilt bracket
- Balanced oven door
- Full extension telescopic shelves **2 sets (part 578744)**
- Full extension telescopic sliding shelves
- Non-tip shelves
- Spill containment **219.53 L**
- Spill containment **5/8 gallon**

SKU 81704

The product dimensions and specifications in this page apply to the specific product and model. Under our policy of continuous improvement, these dimensions and specifications may change at any time. You should therefore check with Fisher & Paykel's Customer Care Centre to ensure this page correctly describes the model currently available. © Fisher & Paykel Appliances Ltd 2020

Other product downloads available at fisherpaykel.com

- ↓ Installation Guide (English)
- ↓ Installation Guide (Canadian French)
- ↓ California Warning Proposition 65 (English, Spanish, Canadian French, Chinese)
- ↓ Revit
- ↓ Rhino
- ↓ Right To Repair Declaration (English, Canadian French)
- ↓ SketchUp
- ↓ User Guide (English)

Where applicable:

All appliances use energy, and energy usage typically generates carbon emissions. **Fisher & Paykel Appliances' In-use Energy Carbon Emissions Estimate** indicates carbon emissions from a product's in-use energy. This is calculated either annually or per cycle, using the product's market-specific energy label energy consumption data multiplied by the carbon emissions factor for energy in your country or region.

Our In-use Energy Carbon Emissions Estimate is designed to assist customers in making informed purchasing decisions when comparing different Fisher & Paykel products. For example, a heat pump dryer typically has a lower In-use Energy Carbon Emissions Estimate than a vented dryer.



A PEACE OF MIND SALE
24 Hours 7 Days a Week Customer Support
T 1.888.936.7872 W www.fisherpaykel.com