

FISHER & PAYKEL

FREESTANDING WINE CABINETS

**RF206RDWX1, RF306RDWX1
& RF356RDWX1 models**

INSTALLATION GUIDE / USER GUIDE

GB IE

CONTENTS

Introduction	5
Safety and warnings	6
Installation instructions	8
Moving or storing your appliance	14
Operating instructions - External control panel	15
Operating instructions - Special functions	16
Interior and exterior features	17
Storing your wine	20
Loading your wine bottles	21
Cleaning care - Exterior	25
Cleaning care - Interior	26
User warnings and sounds	27
Troubleshooting	28
Manufacturer's Warranty	30
Customer Care	31
European Directive 2012/19/EU on Waste Electrical and Electronic Equipment (WEEE)	33

Registration

To register your product visit our website: fisherpaykel.com/register

INTRODUCTION

Thank you for buying a Fisher & Paykel Wine Cabinet to store your treasured wine, you've made a great choice.

Having purchased our dual-zone cabinet you can rest assured that your red and white wines are well cared for, over short term and long term periods.

Wine generally matures at a steady temperature between 11°C to 13°C, and for ready to drink wines they are best served at their ideal drinking temperatures (see 'Storing your wine' section). Temperature control is critical for the maturation of wines, as significant daily or weekly temperature fluctuations can denature wines. If storage temperatures are excessively high this can reduce the wines aromatic potential and can speed up maturation. This can cause some wines to take on a 'spoiled fruit' flavouring. If storage temperatures are excessively low, this can have the opposite effect and stunt a wines natural maturation process. This can prevent a wines flavours from developing to their full potential.

Other golden rules of excellent wine storage that your Wine Cabinet offers is frequent air circulation, condensation eliminator and minimal vibrations with the low noise compressor.

Optimum humidity levels are also important for the storage of cork enclosed wines, especially for long term storage. Dry surroundings can lead to dried out corks encouraging wine evaporation, as well as oxygen permeation leading to oxidised and/or spoiled wine. As for extremely humid conditions, there is a potential of damaging wine labels and the growth of mould on bottles.

Light is known to be damaging to wines, particularly UV light as it creates hydrogen sulphide compounds in wine affecting the tannins and the colour of wine. Therefore our Wine Cabinets are designed to eliminate this threat by incorporating a UV-tempered glass door, dark interiors and dimmed LED lighting.

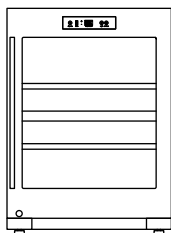

RF106RDWX1 model

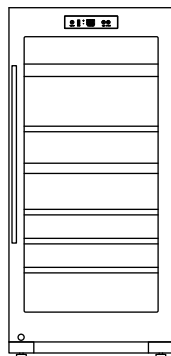

RF206RDWX1 model

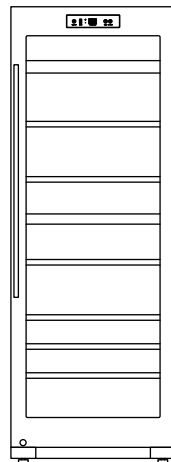

RF306RDWX1 model

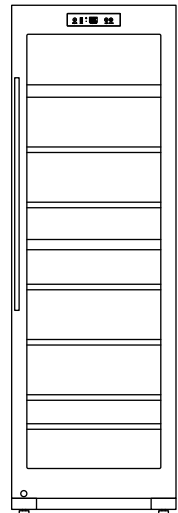

RF356RDWX1 model

SAFETY AND WARNINGS

WARNING!



Electric Shock Hazard

Failure to do so can result in death, electric shock, fire or injury to persons.

- Read and follow the safety and warnings outlined in this user guide before operating this appliance.



R600a

Risk of fire/flammable material

- This refrigerator contains flammable refrigerant isobutane (R600a).

READ AND SAVE THIS GUIDE

Use this appliance only for the intended purpose as described in the user guide. When using this appliance always exercise basic safety precautions including the following:

General

- This product has been designed for use in a normal domestic (residential) environment.
- Persons aged 8 years and over, and persons with reduced physical, sensory or mental capabilities; or those with lack of experience and knowledge; can use this appliance provided they are supervised or have been given instruction for safe use.
- Children aged 3 to 8 years may load and unload this appliance under supervision.
- Children should not play with the appliance and should not carry out user maintenance without supervision.
- To ensure the appliance is stable under all conditions, we recommend installing a stability bracket. Please refer to the 'Installation instructions' leaflet supplied.
- Keep ventilation openings, in the appliance enclosure or in the built-in structure, clear of obstruction.
- Do not damage the refrigerant circuit.
- In case of damage to the refrigerant circuit, ventilate the area by opening all windows. Do not operate electrical equipment or any other equipment that may produce arcs, sparks or flames in the area. Contact your Fisher & Paykel trained and supported service technician immediately to arrange for the appliance to be repaired.

Food safety

- This appliance is intended to be used exclusively for the storage of wine.
- Do not store food and milk products in the Wine Cabinet. The interior temperature may not be cool enough to prevent spoilage in food, and the expiry dates stated on the food packaging may be invalid.
- This refrigerating appliance is not suitable for freezing foodstuffs.

SAFETY AND WARNINGS

Electrical safety

- This appliance must be installed in accordance with the installation instructions before use.
- Always grip the plug firmly and pull straight out from the outlet.
- Do not plug in any other appliance at the same power point as your Wine Cabinet.
- Repair or replace immediately all electric service cords that have become frayed or otherwise damaged. Do not use a cord that shows cracks or abrasion along its length, or at either the plug or appliance end.
- If the power supply cord is damaged, it must only be replaced by your Fisher & Paykel trained and supported service technician.
- When moving your appliance, be careful not to roll over or damage the power cord.
- Do not use electrical appliances inside the Wine Cabinet.
- Do not use mechanical devices or other means to accelerate the defrosting process, other than those recommended by the manufacturer.
- When positioning the appliance, ensure the power cord is not trapped or damaged.
- Do not locate multiple portable socket-outlets or portable power supplies at the rear of the appliance.

Servicing

- Your Wine Cabinet is designed to operate without the need for regular service checks. However, if your Wine Cabinet is malfunctioning, have it attended to by your Fisher & Paykel trained and supported service technician as soon as possible.
- The LED light cannot be serviced by the user. Contact your Fisher & Paykel Dealer or Fisher & Paykel trained and supported service technician.

Cleaning

- Many commercially available cleaning products contain solvents which may attack plastic components of your Wine Cabinet and cause them to crack. Please refer to the 'Cleaning care' section of this user guide for further advice.

Disposal and recycling

- Extreme care must be taken when disposing your old appliance to avoid hazards:
 - The flammable refrigerant gas must be safely removed.
 - The thermal insulation foam contained in this appliance is produced by flammable blowing gases, any exposed foam may be highly flammable and must be carefully treated during disposal.
 - The doors should be removed, if possible and the shelves left in place so that children may not easily climb inside.
 - Your Fisher & Paykel trained and supported service technician will be able to give advice on environmentally friendly methods of disposing your old Wine Cabinet.

Storing wine

- DO NOT store explosive substances such as aerosol cans with a flammable propellant in this appliance.
- Never store volatile or flammable materials in your Wine Cabinet as they may explode.

INSTALLATION INSTRUCTIONS

Power failure

- In the event of a power interruption, the Wine Cabinet will automatically save the current temperature settings. When power is recovered, the Wine Cabinet will revert to the current temperature settings only.
- Most power failures are corrected within a short period of time. 1 - 2 hours loss of power will not affect the Wine Cabinet's temperatures.
- To avoid sudden change of temperature while the power is off, you should avoid opening the door. For longer periods of power failure, do take steps to protect your wine.

INSTALLATION INSTRUCTIONS

Please follow the installation steps below to ensure your appliance operates correctly.

Power

- The appliance must be installed so the plug is accessible.
- To ensure that the appliance is not accidentally switched off, connect your Wine Cabinet to its own power point. Do not plug in any other appliance at this power point.
- For power requirements, please refer to the serial plate located on the rear of the cabinet.
- It is essential that the appliance is properly grounded (earthed).
- Connect the appliance to the electrical supply (220 V – 240 V 50Hz) with the fitted plug and lead.
- Connections to the mains supply should be in accordance with local regulations.

Location

- Your Wine Cabinet should not be located in direct sunlight or next to any heat generating appliance such as a cooktop, oven or dishwasher.
- The appliance should not be located in garages or on carpeted floors.
- This refrigerating appliance is intended to be used at ambient temperatures ranging from 16 °C to 38 °C.
- For optimum performance, it is recommended to control the ambient temperature between 16°C and 25°C.

Ventilation and installation

To ensure adequate ventilation for your Wine Cabinet remove external protective packaging film, and see recommended 'Product and cabinetry dimensions'.

INSTALLATION INSTRUCTIONS

Product installation

- Your Wine Cabinet is fitted with rear rollers designed for moving the product in the forwards and backwards direction.
- Avoid moving the product in a sideways direction as this may damage the floor covering/surface.
- Your Wine Cabinet will arrive with the front feet raised making moving the product into its final location a simple task.
- Move the Wine Cabinet into its final position making sure there is correct clearances between the product and surrounding cabinetry.

Aligning your Wine Cabinet with cabinetry

- Align the sides of the product with the cabinetry by adjusting the hinge side front foot.
- Adjust the handle side foot until it touches the floor and takes a small amount of weight.
- Once the product is in place and aligned with cupboards/alcove gently push on the front top and check if the product is rocking or stable.

Levelling your Wine Cabinet

- It is important that all four corners of the Wine Cabinet base are supported firmly on the floor to eliminate any cabinet movement.
- Installing the appliance on a soft or uneven/unlevelled floor may result in twisting of the cabinet and poor sealing of the door.
- The cabinet has adjustable feet, which can be used to level the product. Remove the feet cover, turn the feet clockwise to raise the appliance or counter-clockwise to lower the appliance, until it is stable. This will ensure a good door closing action. Replace the feet cover.
- The front levelling foot on the hinge side should take majority of the cabinet's weight and be stable, i.e. the cabinet should not rock or wobble.

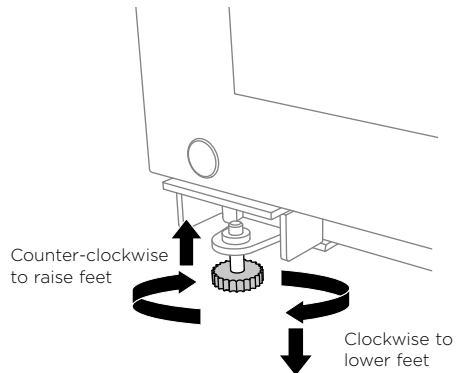
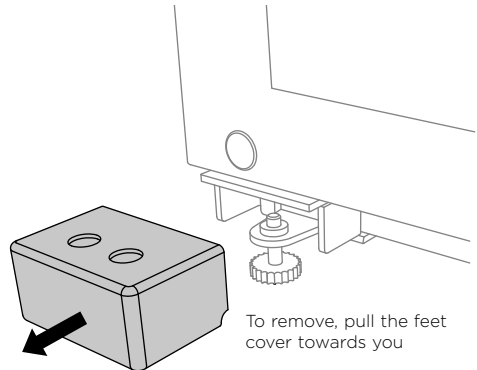

INSTALLATION INSTRUCTIONS

Product and cabinetry dimensions

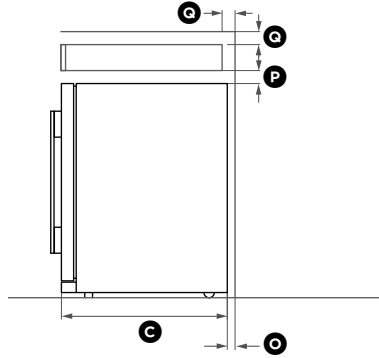
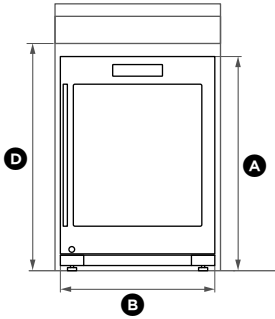

Flush with Wine Cabinet chassis - full door rotation

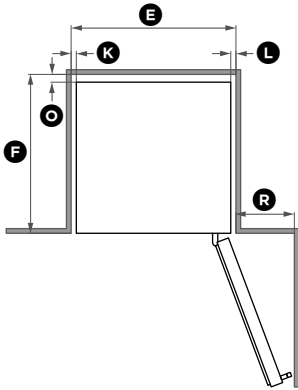

Flush with Wine Cabinet door - full door rotation

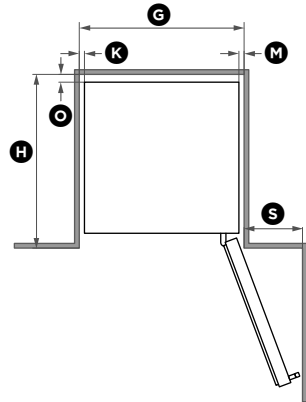

Flush with Wine Cabinet door - 90° door rotation

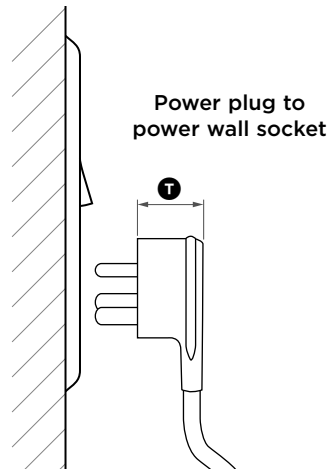
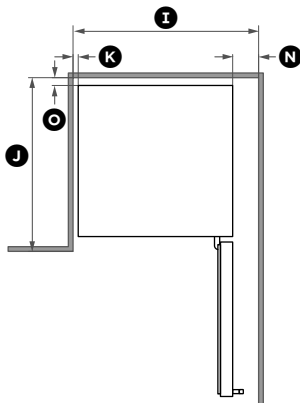

INSTALLATION INSTRUCTIONS

	RF106RDWX1	RF206RDWX1	RF306RDWX1	RF356RDWX1
PRODUCT DIMENSIONS				mm
(A) Overall height of product	825	1270	1660	1855
(B) Overall width of product	595	595	595	595
(C) Overall depth of product (excludes handle, includes back cover)	639	639	639	639
CABINETRY DIMENSIONS (Including minimum air clearances)				mm
(D) Inside height of cavity	875	1320	1710	1905
Flush with Wine Cabinet chassis - full door rotation				
(E) Inside width	635	635	635	635
(F) Inside depth	612	612	612	612
Flush with Wine Cabinet door - full door rotation				
(G) Inside width	635	635	635	635
(H) Inside depth flush to flat door	669	669	669	669
Flush with Wine Cabinet door - 90° door rotation (for full shelf access, the door needs to be open past 90°)				
(I) Inside width	715	715	715	715
(J) Inside depth flush to flat door	669	669	669	669
MINIMUM CLEARANCES				mm
(K) Side clearance	20	20	20	20
(L) Side clearance - hinge side flush with chassis - full rotation	20	20	20	20
(M) Side clearance - hinge side flush with door - full rotation	20	20	20	20
(N) Side clearance - hinge side flush with door - 90° rotation	100	100	100	100
(O) Rear clearance (includes back cover)	30	30	30	30
(P) Top clearance - above Wine Cabinet	50	50	50	50
(Q) Vent - around top of cupboard (optional)	50	50	50	50
(R) Door clearance - hinge side flush with chassis - full rotation	225	225	225	225
(S) Door clearance - hinge side flush with door - full rotation	225	225	225	225
MINIMUM POWER PLUG DIMENSIONS				mm
(T) Power plug depth	30	30	30	30

INSTALLATION INSTRUCTIONS

What to do if your Wine Cabinet is unstable

- ① Gently push the Wine Cabinet back until the rear contacts the floor.
 - Measure the gap under the front foot, which has come off the floor.
 - Obtain some solid packing material (hardwood, plastic, etc) which fits firmly into the gap under the foot.

IMPORTANT!

Do not use metallic materials that may corrode, stain and/or damage floor coverings.

- ② Wind both front feet up and ease the cabinet out of position.
 - Place the packing material in the location diagonally opposite the front foot that lifts off the floor.
 - Make sure the packing material stays in place when the product is pushed back into position.
 - Ideally, the packing material is large enough to rest against the back wall to prevent it from moving when the cabinet is pushed back into position.
- ③ Push the Wine Cabinet back into position and adjust the front feet. Check alignment and door closing action are satisfactory.
 - Make small adjustments to the front feet where necessary, and ensure the product is stable.

Before placing wine in your Wine Cabinet

- Remove all internal packaging.
- Clean the inside of the appliance to remove manufacturing and transportation dust. Please refer to the 'Cleaning care' section of this user guide for further advice.
- Allow the Wine Cabinet to run empty for 1 - 2 hours, this allows the appliance to acclimatize and remove any residual odours before making temperature adjustments.
- Ensure your Wine Cabinet has adequate ventilation.
- Do not cover you appliance with any material that will prevent air from flowing around the cabinet sides.

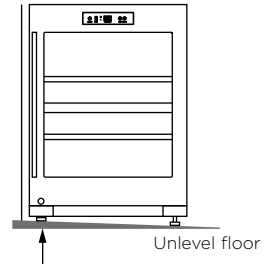

This foot lifts off the floor when top front is gently pushed back

Packing material goes under rear foot diagonally opposite front foot that lifts

Wall behind Wine Cabinet

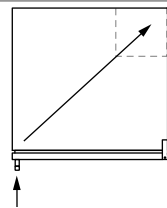

For example: if this foot lifts off the floor when pushing gently on the top front of the Wine Cabinet

MOVING OR STORING YOUR APPLIANCE

If your Wine Cabinet is turned off for any reason, wait 10 minutes before turning it back on. This will allow the refrigeration systems pressures to equalise before restarting.

Moving your appliance

- Turn off the appliance and unplug from the power point. Remove all wine bottles.
- Turn the adjustable feet counter-clockwise to lower the product, making sure the feet are wound up into the product.
- Ease the appliance out of its position. Tape the power cord to the back of the Wine Cabinet, tape the shelves in place and tape the door closed.
- Always move the appliance vertically. Do not transport the product lying down, this potentially damages the sealed cooling system.
- Relocate and install. If the appliance has been left on its side for any length of time, leave it standing upright as long as possible (at least a few hours) before turning it on.
- If the product has been transported upright then it can be switched on after 10 minutes.

Storing your Wine Cabinet

- When storing your cleaned appliance, leave the door open. This allows air to circulate and prevents the build-up of bacteria and moulds.
- Before using again, clean well using liquid dishwashing detergent dissolved in warm water. Rinse with clean water and dry with a lint-free cloth.

Holiday time

We recommend you leave your Wine Cabinet operating while you are on holiday.

OPERATING INSTRUCTIONS - EXTERNAL CONTROL PANEL

The control panel enables you to view and modify all the features and options on your Wine Cabinet.



Temperature control

- When the Wine Cabinet is turned on for the first time, the control panel will display the actual temperature of the cabinet.
- The system will automatically cool both zones to their default temperature setting of 12°C (ideal for long term storage). This will take between 1 - 2 hours.
- The temperature zones are independently controlled and do not change with the temperature or humidity of the surrounding; whether summer or winter.
- The Wine Cabinet can be set to any temperature between 5°C and 20°C in each zone to accommodate your wine storage requirements.
- If you wish to alter the temperature of either zone, this can be easily done by using the external control panel.

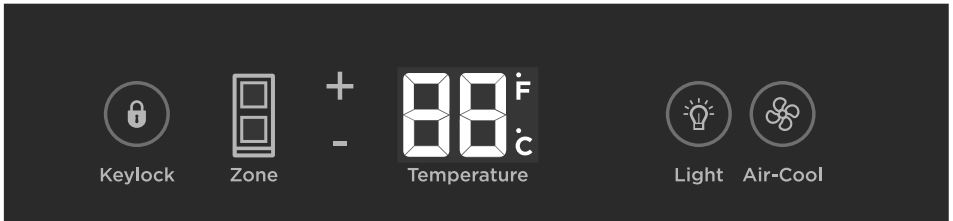
External control panel





Adjusting the temperature of each zone

- ① The zone last selected will automatically be illuminated.
- ② Press and hold the 'Keylock'  button for 3 seconds to unlock the external control panel. When unlocked the back lit LED lights intensify.
- ③ To change zones press the 'Zone'  button once.
- ④ The temperature may be altered by pressing the **+** or **-** buttons. One press on either of these buttons will increase or reduce the temperature by one °C or °F. When the desired temperature is displayed, wait 3 seconds, the blinking will stop and the temperature will be set.
- ⑤ To switch between temperature units of °C and °F, press the 'Air-Cool'  button for 3 seconds.

Special functions

Keylock



The external control panel automatically locks from any key presses after 30 seconds from being enabled.

- To deactivate Keylock and allow key presses. Press the 'Keylock'  button for 3 seconds, when unlocked the back lit LED lights intensify.
- To activate Keylock press the 'Keylock'  button for 3 seconds, when locked the back lit LED lights will dim.

LED lighting

When the Wine Cabinet door is opened the light automatically illuminates both zones. When the door is closed the light will automatically turn off. For maximum energy savings, it is recommended to leave the light off when not viewing your collection.

To keep the light illuminated at all times (on door opening or closing):

- Press the 'Light'  button once and the icon will illuminate.
- To deactivate the light from illuminating when not viewing your collection, press the 'Light'  button once. The icon will no longer illuminate.

Air-Cool

The interior fans provide a constant and evenly distributed air flow throughout the cabinet, ensuring the optimum environment for wine storage. This function is recommended when large amounts of wine bottles are added at any one time.

- To activate press the 'Air-Cool'  button once and the icon will illuminate.
- To deactivate press the 'Air-Cool'  button once. The icon will illuminate.

Door alarm

A continuous alarm will sound if the cabinet door has been left open for longer than 60 seconds. The alarm will stop only when the door is closed.

- For times when you require the door to be opened longer than normal eg rotating your wine bottles or loading more wine, the door alarm can be temporarily muted.
- To mute the door alarm, press any button on the external control panel once. When the cabinet door is closed, alarm mute will deactivate and the door alarm will revert to normal.

IMPORTANT!

When the cabinet door is left open for long periods of time wine quality may be compromised.

Automatic defrosting

- This model has been designed to maintain the relative humidity inside the Wine Cabinet alongside the automatic defrosting cycle.
- Water captured in the reservoir tray from a defrost cycle assists in maintaining the humidity. Humidity levels may be further assisted by adding water to the reservoir trays and activating the 'Air-Cool' function.

INTERIOR AND EXTERIOR FEATURES

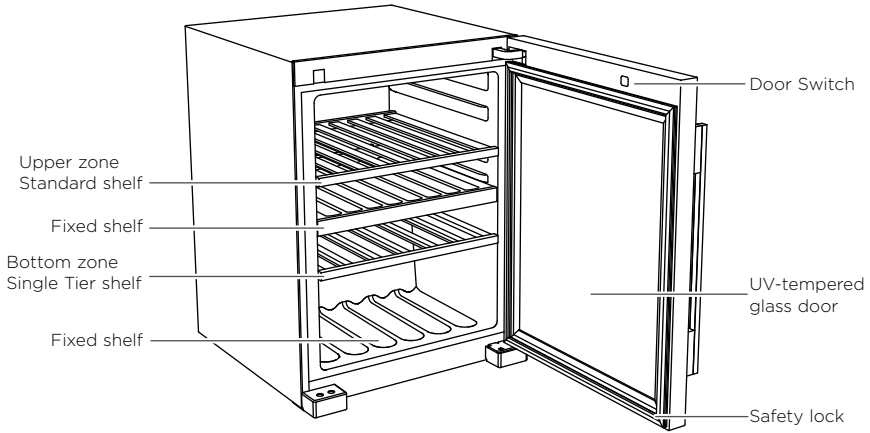

RF106RDWX1 model

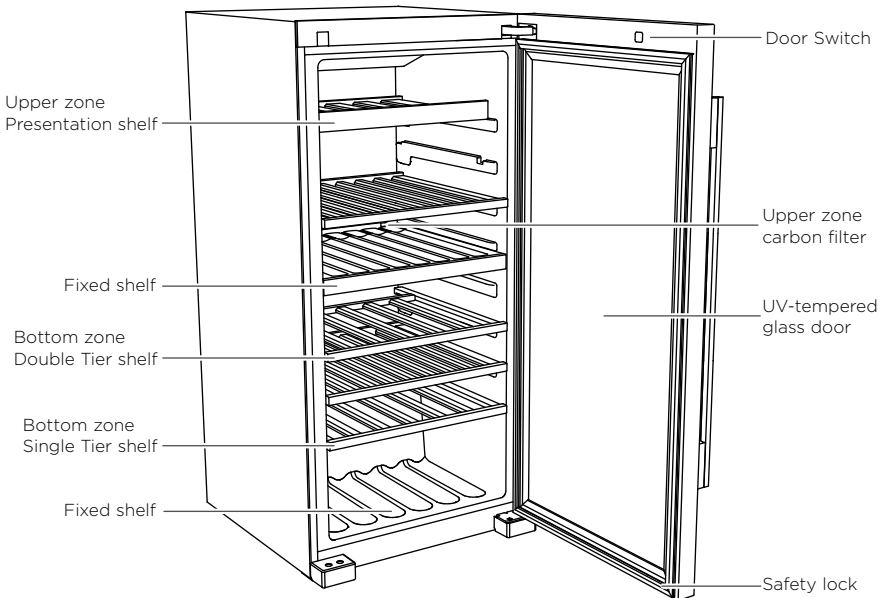

RF206RDWX1 model

INTERIOR AND EXTERIOR FEATURES

Interior features

Shelving

The oak shelves have been designed to allow for even air distribution around your wine bottles. Depending on your model there are a range of adjustable shelves that can be rearranged to suit your storage needs.

Standard shelf (all models)

These shelves are located in both zones and is designed to hold up to 22 Bordeaux bottles depending on the support lugs selected. The ideal loading arrangement for these shelves is to have bottle necks interlocking.

Presentation shelf (excludes RF106RDWX1 model)

These shelves are located in the upper zone only and is designed to hold up to 5 Bordeaux bottles or to store opened bottles when in the tilted state. When not using the Presentation shelf a total of 9 Bordeaux bottles can be stored in the upright position.

To tilt the Presentation shelf:

- ① Hold the front and back edge of the shelf firmly and lift vertically to dislodge from the support lugs (refer to **A**).
- ② Pull the shelf slightly forward and tilt the front edge of the shelf down to the next support lugs (refer to **B**).
- ③ Push the shelf back into the Wine Cabinet until you feel it secure into the support lugs (refer to **C**).

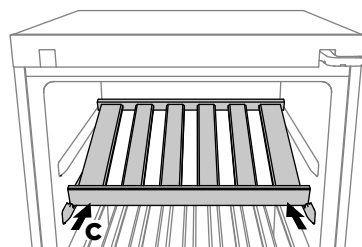
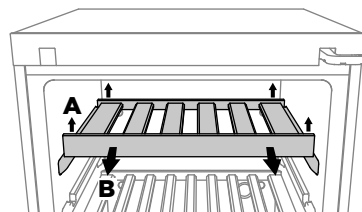

Double Tier shelf (excludes RF106RDWX1 model)

These shelves are located in the bottom zone only and is designed to hold up to 11 Bordeaux bottles. The ideal loading arrangement for these shelves is to have bottle necks facing the back of the Wine Cabinet.

Single Tier shelf (all models)

These shelves are located in the bottom support lugs of the bottom zone only and is designed to hold 6 Bordeaux bottles at any one time.

If removing this shelf please take care of the wine bottles stored underneath (when not storing Bordeaux bottles), as bottles can be easily dislodged.

INTERIOR AND EXTERIOR FEATURES

Activated carbon filters (all models)

Air quality is critical for preserving wine, the activated carbon filters helps to remove stale, unwanted odours and replenishes with fresh air.

- The filters are fitted to the rear wall on the right-hand side of the upper and bottom zone.
- We recommend that you replace your activated carbon filters once every five years. Replacement filters are available from your Fisher & Paykel Authorised Repairer.
- To remove the filter hold by the handle, and turn counter-clockwise (refer to **A**) until fully loosened. Pull towards you to remove (refer to **B**).
- To replace the filter hold by the handle, insert and turn clockwise to fully secure.

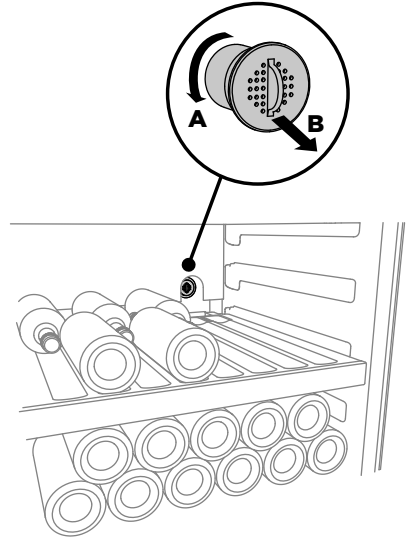

Exterior features

Door lock (all models)

The Wine cabinet is equipped with a door lock located at the bottom left of the cabinet door.

- To lock the cabinet, insert the key and turn 90° counter-clockwise.
- To unlock the cabinet, insert the key and turn 90° clockwise

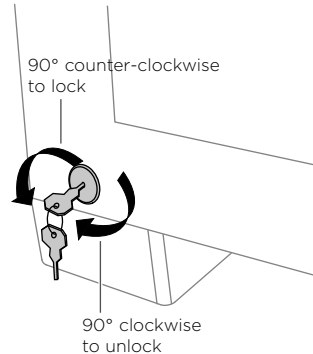

STORING YOUR WINE

Short-term storage/serving

- This Wine Cabinet is perfect for short-term storage such as entertaining.
- Red wines are best served at warmer temperatures and white wines are best served at cooler temperatures.
- The ideal serving temperature of your wine is crucial for your taste and enjoyment. The following are recommended serving temperatures for different wines.

SPARKLING WINES AND SWEET WHITE WINES

Non-vintage Champagne and Sparkling Wine 6°C

Vintage Champagne and Sparkling Wine, Riesling and Gewürztraminer 8°C

DRY WHITE WINES

Sauvignon Blanc, Chenin Blanc, Bordeaux Blanc 9°C

Chardonnay and White Burgundy, Rosé 10 - 12°C

LIGHT TO MEDIUM-BODIED RED WINES

Young Bordeaux, Young Cabernet, Pinot Noir, Merlot 14 - 16°C

FULL-BODIED RED WINES

Cabernet Sauvignon, Red Burgundy 17°C

Shiraz, Zinfandel, Vintage Port 18°C

Long-term storage

- This Wine Cabinet is also perfect for long-term storage/cellaring of wines.
- The ideal temperature for long-term storage of red and white wines is between 11°C to 13°C.

Storing red and white wine

- When storing a combination of red and white wines, we recommend storing same case wines together. For example red wine in the bottom zone and white wine in the upper zone.
- Depending on the number of wine bottles and functions selected, it may take 48 hours for the Wine Cabinet temperatures to stabilise.
- Not all wine stored will improve/mature over time. Some wine are best consumed at an early stage, while others have remarkable ageing capabilities. Do check with your wine merchant for more information.

LOADING YOUR WINE BOTTLES

When loading your Wine Cabinet please keep in mind our loading capacities are based on the standard 750 ml Bordeaux bottles.

The loading arrangement outlined for the following models is recommended when using the Presentation shelf. Maximum capacities are listed, and storage can be maximised by removing the Presentation shelf and replacing with the additional Standard shelf supplied (except RF106RDWX1).

DOs

- Before loading wine into the cabinet confirm that all shelves are secured and stable.
- Store same case bottles in a vertical stack, this enables easy access to all your different wines.
- Arrange the wine bottles you wish to cellar or mature at the back of the shelves and the wines you wish to consume in the short-term at the front.
- Only interlock wine bottles of the same size together. This ensures stacking about the first tier is stable.
- Avoid overcrowding shelves, as this reduces airflow.
- Follow the recommended loading arrangement outlined for each shelf for each model.

DON'Ts

- **Do not load more than the recommended number of wine bottles on each styled shelf.**
- **Do not remove any shelves above another shelf to allow the shelf below to hold more than the recommended number of wine bottles.**
- **Do not interlock wine bottles of different sizes that do not fit well together on a shelf.**

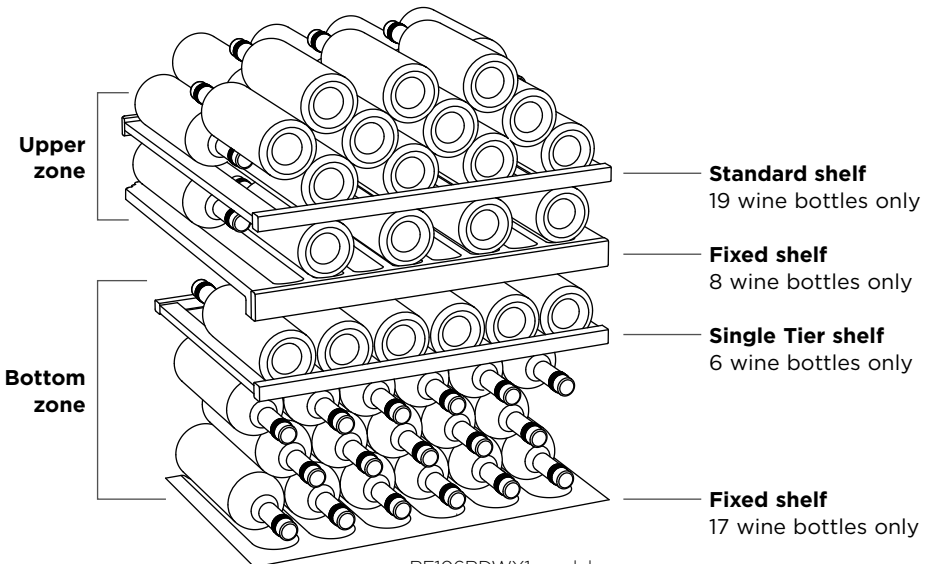

RF106RDWX1 model
Maximum capacity: 50 wine bottles

LOADING YOUR WINE BOTTLES

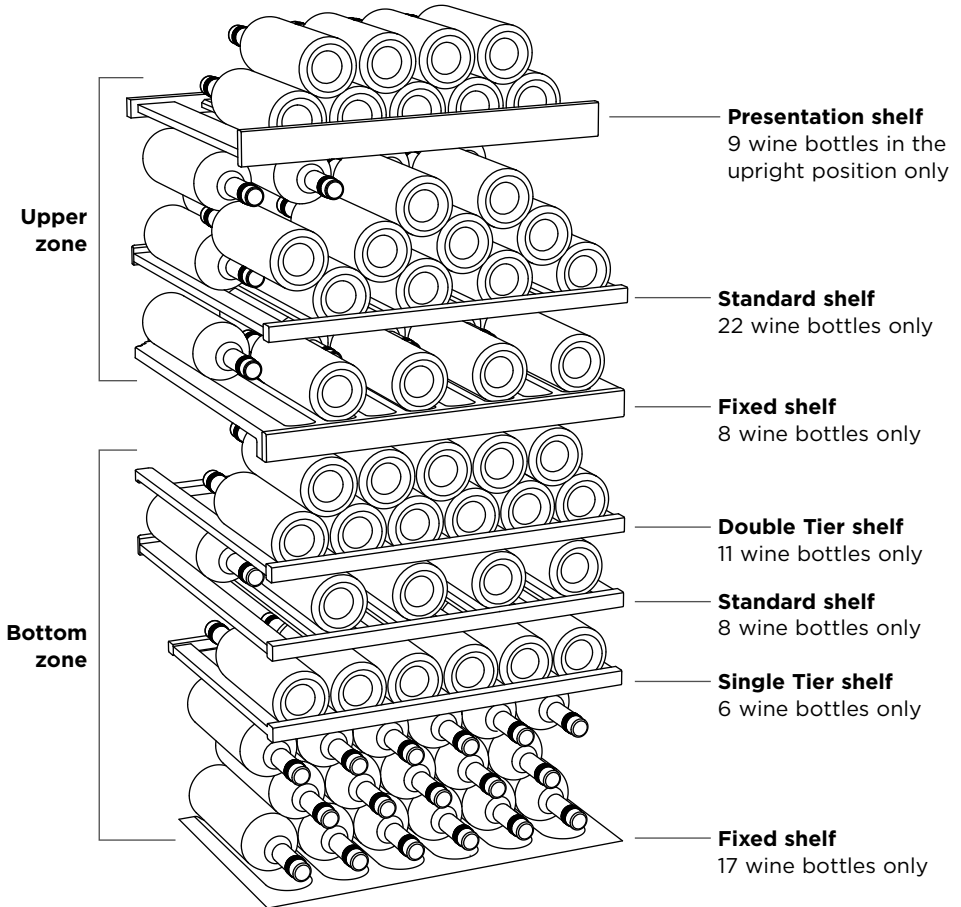

RF206RDWX1 model
Maximum capacity: 83 wine bottles

LOADING YOUR WINE BOTTLES

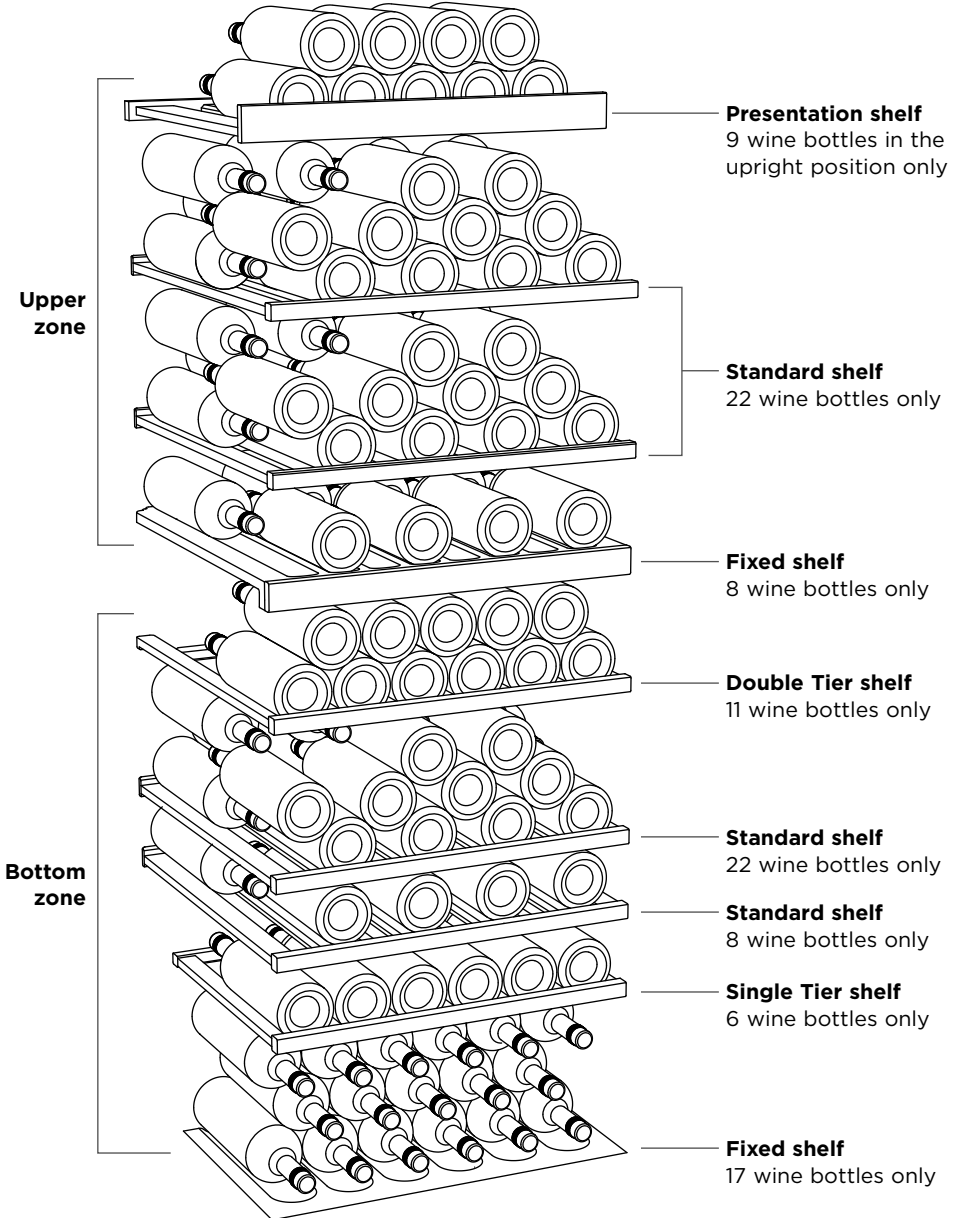

RF306RDWX1 model
Maximum capacity: 127 wine bottles

LOADING YOUR WINE BOTTLES

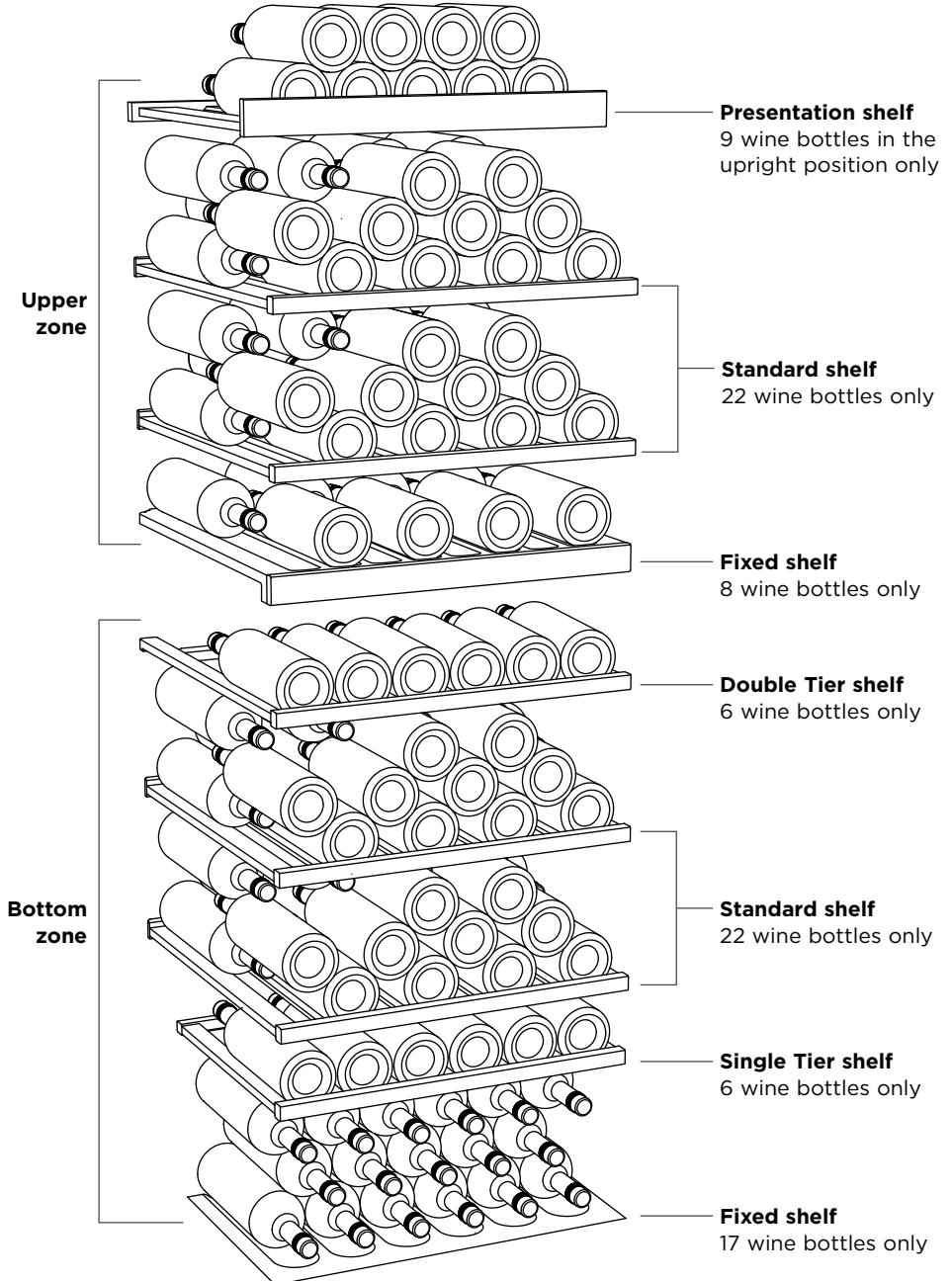

RF356RDWX1 model
Maximum capacity: 144 bottles

CLEANING CARE - EXTERIOR

Stainless steel exterior door

- Use only liquid dishwashing detergent dissolved in warm water and a soft lint-free cloth to clean the exterior door surface.
- Rinse with clean water and dry with a clean, lint-free cloth.
- The use of any abrasive or stainless steel cleaners and solvents will damage the door surface.

Other exterior surfaces

- Clean all other exterior surfaces with liquid dishwashing detergent dissolved in warm water and a soft lint-free cloth.
- Rinse with clean water and dry with a clean, lint-free cloth.

Door gasket

- It is recommended to clean the magnetic door gasket every three months with a soft bristle toothbrush, and washing up liquid dissolved in warm water.
- Gasket must be kept clean and pliable to assure a proper seal.
- Petroleum jelly applied lightly on the hinge side of the gasket will keep the gasket pliable and assure a good seal.

IMPORTANT!

- **Many commercially available cleaning products contain solvents which may attack plastic components of your Wine Cabinet and cause them to crack.**
- **Avoid using anti-bacterial cleaning products on the interior or exterior of the Wine Cabinet, as they may cause rusting of metal components and cracking of plastic components.**

Interior

- For ease of cleaning, empty the Wine Cabinet first and remove all shelves.
- Wipe interior surfaces using only washing up liquid dissolved in warm water and a soft lint-free cloth. Rinse with clean water and dry with a clean, lint-free cloth.
- Do not use harsh chemicals, abrasives, ammonia, chlorine, bleach, concentrated detergents, solvents or abrasive scouring pads on any part of your Wine Cabinet. SOME of these chemicals may dissolve, damage and/or discolour the interior of your Wine Cabinet.

Adjustable shelves

- When cleaning use only a dry clean, lint-free cloth to wipe over surfaces. Do not use warm water or any cleaners as this will damage the shelves' oak characteristics and cause them to warp and stain.
- If the shelves are lightly stained by split wine or water allow the surface to dry, then using 200 grade sandpaper gently sand over the stain until removed. Wipe down the area with a dry clean, lint-free cloth to remove remaining sawdust.
- If shelves are heavily stained, over time the colour of the shelf will darken and warp, and may eventually require replacing. Replacement shelves are available from your Fisher & Paykel Authorised Repairer.

To remove adjustable shelves

Depending on your model there are a range of adjustable shelves that can be rearranged to suit your storage needs.

- ① For ease of removal, empty the shelf first.
- ② Hold the back of the shelf and lift vertically to dislodge from back support lugs.
- ③ Pull the shelf towards you to remove.

Repositioning adjustable shelves

- ① Align the back edge of the shelf onto the desired support lugs.
- ② Push the shelf back into the Wine Cabinet until you feel it secure into the back support lugs.
- ③ Ensure the shelf is secure before use.

Fixed shelves

The centre and bottom shelf of each model are permanently fixed. They cannot be removed from the Wine Cabinet. To clean, simply wipe with a damp, lint-free cloth.

USER WARNINGS AND SOUNDS

User warnings – faults

In the unlikely event of a fault occurring, a fault code will be displayed on the external control panel and an alarm will sound.

- Please take note of the fault code and contact our Customer Care Centre. Contact details are located towards the end of the user guide.
- To silence the fault alarm press any button on the external control panel. The fault code will remain illuminated until the fault is corrected.

Normal Wine Cabinet sounds

Fisher & Paykel Wine Cabinets, can produce sounds somewhat different to your old Wine Cabinet.

Normal operational sounds include:

- Fan air flow sounds. Fisher & Paykel Wine Cabinets have fans to circulate the air within each zone. This is quite normal.
- Running/boiling water, gurgling sounds or slight vibrations. This is the liquid refrigerant circulating in the system.
- Clicking sounds. This is the thermostat control and will click when it cycles on and off.
- Gasket noises. This normally occurs due to a build-up of dirt and/or grime. It is recommended to clean the magnetic door gasket every three months to minimise these noises occurring.
- Other sounds may be heard of for the following reasons:
 - Cabinet not level
 - Floor uneven or weak
 - Wine bottles not positioned on the shelf correctly.

TROUBLESHOOTING

If there is a problem with your Wine Cabinet, please check the following points before contacting your local Fisher & Paykel Authorised Repairer or Customer Care Centre.

Product parts and accessories can be purchased through Fisher & Paykel Customer Care or online at fisherpaykel.com (this service is available to selected markets only).

PROBLEM	POSSIBLE CAUSES	WHAT TO DO
Appliance does not operate.	No electricity at the power outlet.	Check the cabinet is correctly connected and the power is switched on.
		Check another appliance at the same outlet.
		Check the house fuse.
Lights do not illuminate when the door is opened.	Cabinet is not working.	Check the cabinet is turned on at the wall.
	Lights not functioning.	The LED lights cannot be service by the user. Contact your Fisher & Paykel Dealer or Fisher & Paykel Authorised Repairer.
Motor operates for long periods.	The room temperature is hotter than normal.	Minimise door openings to allow temperature to stabilise.
	Prolonged or frequent door openings.	
	Large amount of wine bottles added.	
	Temperature setting is too low.	Refer to 'Operating instructions - External control panel' and 'Storing your wine' sections for optimal temperature settings.
	Door not sealed properly.	Check the cabinet is level and gasket seals are clean.
Wine bottles appear too warm.	Temperature setting not correct.	Adjust the temperature control to a colder setting. Refer to the 'Operating instructions - External control panel' sections.
	Prolonged or frequent door openings.	Minimise door openings to allow temperature to stabilise.
	Large amount of wine bottles added.	Allow time for recently added wine bottles to reach the desired temperature. Activate 'Air-Cool' function. Refer to 'Operating instructions - Special functions' section.

TROUBLESHOOTING

PROBLEM	POSSIBLE CAUSES	WHAT TO DO
Wine bottles appear too cold.	Temperature setting not correct.	Adjust the temperature control to a warmer setting. Refer to 'Operating instructions – External control panel' sections.
Unfamiliar noises.	The cabinet is not stable or level.	Level the cabinet. Refer to the 'Installation instructions' section or refer to 'User warnings and sounds' section.
Door alarm sounds continuously and a fault code appears.	This is dependent on the displayed fault code.	Please take note of the fault code and contact the Customer Care Centre.
Exterior of cabinet is warm.	This is normal.	
Moisture build-up on the exterior appliance surfaces.	Not unusual during periods of high humidity.	Wipe dry with a clean, lint-free cloth.
Moisture build up on the interior glass door.	Not unusual during periods of high humidity. Prolonged or frequent door openings.	Wipe dry with a clean, lint-free cloth. Minimise door openings to allow the temperature to stabilise. Also check the gasket is sitting flat and sealing tightly.
Door handle out of alignment.	With time and usage, movement may occur.	Refer to 'Installation instructions' sections.
Excessive gasket noise.	May be due to a build-up of dirt and/or grime.	Gasket needs cleaning. Refer to 'Cleaning care – Exterior' section.
Door does not shut properly.	Cabinet not stable or level. The gasket is dirty. The shelves are out of position. Door obstruction.	Level the cabinet. Refer to the 'Installation instructions' section. Gasket needs cleaning. Refer to the 'Cleaning care – Exterior' section. Realign shelves. Refer to the 'Cleaning care – Interior' section. Check for obstructions eg protruding wine bottles, shelves out of position.

MANUFACTURER'S WARRANTY

For New Zealand, Australia, Singapore, UK, the Republic of Ireland and Northern Ireland only. You automatically receive a 2 year Manufacturer's Warranty with the purchase of this refrigerator covering parts and labour for servicing within the country of purchase.

For spare parts, please contact Fisher & Paykel Customer Care. Spare parts are available for all Fisher & Paykel refrigerators for a minimum period of 10 years from the date of manufacture.

Fisher & Paykel undertakes to:

Repair or, at its option, replace without cost to the owner either for material or labour any part of the product, the serial number of which appears on the product, which is found to be defective within TWO YEARS of the date of purchase.

Note: this Manufacturer's Warranty is an extra benefit and does not affect your legal rights.

This Manufacturer's Warranty DOES NOT cover

- (A) Service calls which are not related to any defect in the product. The cost of a service call will be charged if the problem is not found to be a product fault. For example:
 - ① Correcting the installation of the product.
 - ② Instructing you how to use the product.
 - ③ Replacing house fuses or correcting house wiring or plumbing.
 - ④ Correcting fault(s) caused by the user.
 - ⑤ Noise or vibration that is considered normal, eg drain/fan sounds, refrigeration noises or user warning beeps.
 - ⑥ Correcting damage caused by pests, eg rats, cockroaches, etc.
 - ⑦ Replacement light bulbs.
- (B) Defects caused by factors other than:
 - ① Normal domestic use; or
 - ② Use in accordance with the product's user guide.
- (C) Defects to the product caused by accident, neglect, misuse or 'act of God'.
- (D) The cost of repairs carried out by non-authorized repairers or the cost of correcting such unauthorised repairs.
- (E) Normal recommended maintenance as set out in the product's user guide.
- (F) Repairs when the appliance has been dismantled, repaired or serviced by other than a Fisher & Paykel Authorised Repairer or the selling dealer.
- (G) Pick-up and delivery.
- (H) Transportation or travelling costs involved in the repair when the product is installed outside the Fisher & Paykel Authorised Repairer's normal service area.
- (I) Filter replacement except in the case of faulty parts or materials within the filter cartridge.
- (J) Damage (including water damage) caused by faulty installation or plumbing.

This product has been designed for use in a normal domestic (residential) environment. This product is not designed for any commercial use (whatsoever). Any commercial use by a customer will affect this product's Manufacturer's Warranty.

Service under this Manufacturer's Warranty must be provided by a Fisher & Paykel Authorised Repairer (refer to the 'Customer Care' section at the back of this book). Such service shall be provided during normal business hours. This Manufacturer's Warranty certificate should be shown when making any claim.

CUSTOMER CARE

Before you call for service or assistance...

Check the things you can do yourself. Refer to your user guide and check that:

- ① Your product is correctly installed.
- ② You are familiar with its normal operation.
- ③ You have read the 'Troubleshooting' section at the back of the book.

If after checking these points you still need assistance or parts, please refer to your nearest Authorised Service Centre, Customer Care, or contact us through our website fisherpaykel.com.

In the United Kingdom if you need assistance...*

Call the Fisher & Paykel Customer Care Centre and talk to one of our Customer Care Consultants.

Phone: 08000 886 605

Fax: 08000 886 606

Website: fisherpaykel.com

Postal address: Fisher & Paykel Appliances Ltd, Maidstone Road, Kingston, Milton Keynes, Buckinghamshire, MK10 0BD

In Ireland if you need assistance...*

Phone: 1800 625 174 or 01-8077960

Fax: 1800 635 012

Website: fisherpaykel.com

Postal address: Fisher & Paykel Appliances, Unit D2, North Dublin Corporate Park, Swords, Co. Dublin

For rest of the world...*

Call your Fisher & Paykel retailer/dealer from whom you purchased the product. They are trained to provide information on your appliance. If we can be of any further help, please contact use on:

Phone: +64 9 273 0660

Fax: +64 9 273 0580

Website: fisherpaykel.com

Postal address: Fisher & Paykel Appliances, PO Box 58732, Botany, Manukau 2163, Auckland, New Zealand

*If you call, write or contact us via our website please provide: your name and address, model number, serial number, date of purchase and a complete description of the problem. This information is needed in order to better respond to your request for assistance.

For product details please refer to the serial plate located on the rear of the cabinet.

CUSTOMER CARE

Registration

Register your product with us so we can provide you with the best service possible.
To register your product visit our website: fisherpaykel.com

Complete and keep for safe reference:

Model _____

Serial No. _____

Purchase Date _____

Purchaser _____

Dealer _____

Suburb _____

Town _____

Country _____

EUROPEAN DIRECTIVE 2012/19/EU ON WASTE ELECTRICAL AND ELECTRONIC EQUIPMENT (WEEE)

EU This appliance is marked according to the European directive 2012/19/EU on Waste Electrical and Electronic Equipment (WEEE). By ensuring this product is disposed of correctly, you will help prevent potential negative consequences for the environment and human health, which could otherwise be caused by inappropriate handling of this product.

The symbol  marked on the serial plate, or on the documents accompanying the product, indicates that this appliance cannot be treated as household waste. It shall be handed over to the applicable collection point for the recycling of electrical and electronic equipment. Disposal of the appliance shall be carried out in accordance with the local environment regulations for waste disposal and ensure the refrigerant circuit is not damaged.

For more detailed information about treatment, recovery and recycling of this product, please contact your local city office, your household waste disposal service or your Fisher & Paykel retailer/dealer from whom you purchased this product.

FISHERPAYKEL.COM

© Fisher & Paykel Appliances 2020. All rights reserved.

The models shown in this guide may not be available in all markets
and are subject to change at any time.

The product specifications in this guide apply to the specific products and
models described at the date of issue. Under our policy of continuous product
improvement, these specifications may change at any time.

For current details about model and specification availability in your country,
please go to our website or contact your local Fisher & Paykel dealer.

843686D 08.20