

FISHER & PAYKEL

**ACTIVESMART™ REFRIGERATOR,
VERTICAL REFRIGERATOR
AND VERTICAL FREEZER**

RF331T, RF381T, RF411T, E415H, RF440T, E521T,
RF521T, E373, E450, E308 & E388 models

INSTALLATION GUIDE / USER GUIDE

NZ AU GB IE EU AE CN HK SG

CONTENTS

Model numbers	2
Introduction	3
Safety and warnings	4
Installation instructions	9
Moving or storing your appliance	15
ActiveSmart™ operating instructions	16
ActiveSmart™ special features	18
Activesmart™ cleaning care instructions	21
ActiveSmart™ user warnings and sounds	25
Vertical Refrigerator operating instructions	26
Vertical Refrigerator special features and maintenance	27
Vertical freezer operating instructions	28
Vertical refrigerator and vertical freezer cleaning care instructions	29
Storing food in your refrigerator	31
Storing food in your freezer	33
Troubleshooting	35
Service & Warranty	39
European Directive 2012/19/EU on Waste Electrical and Electronic Equipment (WEEE)	40

IMPORTANT!

SAVE THESE INSTRUCTIONS

The models shown in this User guide may not be available in all markets and are subject to change at any time. For current details about model and specification availability in your country, please go to our website fisherpaykel.com or contact your local Fisher & Paykel dealer.

Registration

Register your product with us so we can provide you with the best service possible.

To register your product visit our website: fisherpaykel.com

MODEL NUMBERS

ACTIVESMART™ REFRIGERATOR MODELS

635mm wide	RF331T, RF381T, RF411T, E415H
------------	-------------------------------

680mm wide	RF440T
------------	--------

790mm wide	E521T, RF521T
------------	---------------

VERTICAL REFRIGERATOR MODELS

635mm wide	E373, E450
------------	------------

VERTICAL FREEZER MODELS

635mm wide	E308, E388
------------	------------

INTRODUCTION

Thank you for buying a Fisher & Paykel ActiveSmart™ refrigerator.

At Fisher & Paykel we are very proud of this refrigerator. This refrigerator combines size and storage space with the latest features and functions.

Thousands of hours of food care research and refrigeration experience has been programmed into your refrigerator to give you the best possible performance.

We hope you enjoy your new refrigerator.

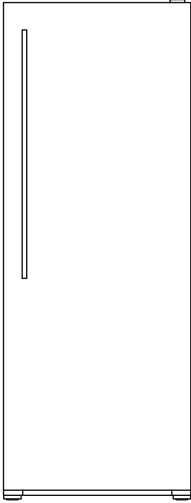

E450 refrigerator

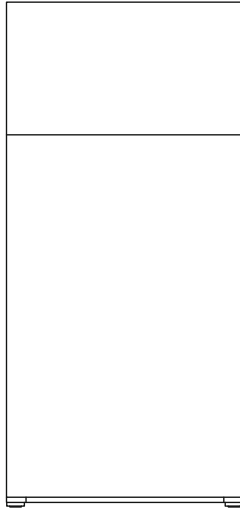

E521T refrigerator

Note: this guide covers all models listed on previous page.
Diagrams above show examples of two of the models covered in this book.

ActiveSmart™ refrigerators have two handle options, shown below.

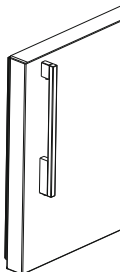

Designer handles



Recessed handles

⚠ WARNING!



Electric Shock Hazard

Read and follow the safety and warnings outlined in this User guide before operating this appliance.

Failure to do so can result in death, electric shock, fire or injury to persons.



R600a

This refrigerator contains flammable refrigerant isobutane (R600a).

Use this appliance only for the intended purpose as described in the User guide.

IMPORTANT SAFETY INSTRUCTIONS:

WARNING!

When using this appliance always exercise basic safety precautions including the following:

- **This appliance can be used by children aged from 8 years and above and persons with reduced physical, sensory or mental capabilities or lack of experience and knowledge if they have been given supervision or instruction concerning use of the appliance in a safe way and understand the hazards involved.**
- **Children should be supervised to ensure that they do not play with the appliance.**
- **Cleaning and user maintenance shall not be made by children without supervision.**

- **The manufacturer's installation instructions for product and cabinetry ventilation must be followed when installing the appliance.**
- **To avoid hazard due to instability of the appliance, it must be fixed in accordance with installation instructions.**
- **WARNING: Keep ventilation openings, in the appliance enclosure or the built-in structure, clear of obstruction.**
- **WARNING: Do not use mechanical devices or other means to accelerate the defrosting process, other than those recommended by the manufacturer.**
- **WARNING: Do not damage the refrigerant circuit.**
- **In case of damage to the refrigerant circuit, ventilate the area by opening all windows. Do not operate electrical equipment or any other equipment that may produce arcs, sparks or flames in the area. Contact your Fisher & Paykel trained and supported service technician immediately to arrange for the appliance to be repaired.**
- **It is hazardous for anyone other than an authorised service person to service this appliance. In Queensland the authorised service person must hold a gas work licence or authorisation for hydrocarbon refrigerants to carry out service or repairs which involve removal of covers.**

Electrical

- **This appliance must be installed in accordance with the installation instructions before use.**
- **To allow disconnection of the appliance from the supply after installation, incorporate a switch in the fixed wiring in accordance with the wiring rules.**

- **Never unplug your refrigerator by pulling on the power cord. Always grip the plug firmly and pull straight out from the outlet.**
- **Do not plug in any other appliance at the same power point as your refrigerator or use extension cords or double adapters.**
- **Repair or replace immediately all electric service cords that have become frayed or otherwise damaged. Do not use a cord that shows cracks or abrasion along its length or at either the plug or appliance end.**
- **If the power supply cord is damaged, it must only be replaced by your Fisher & Paykel trained and supported service technician because special purpose tools are required.**
- **When moving your appliance away from the wall, be careful not to roll over or damage the power cord.**
- **WARNING: Do not use electrical appliances inside the food storage compartments of the appliance, unless they are of the type recommended by the manufacturer.**

IMPORTANT!

Your refrigerator is designed to operate for many years without the need for service checks. However, if your refrigerator is malfunctioning, have it attended to by your Fisher & Paykel trained and supported service technician as soon as possible. All electrical repairs must be carried out by an adequately trained service technician or qualified electrician.

Cleaning

- **Many commercially available cleaning products contain solvents that may attack the plastic components of your refrigerator and cause them to crack.**
- **Avoid using anti-bacterial cleaning products on either the interior or exterior of the cabinet as they may cause rusting of metal components and cracking of plastic components.**
- **Please refer to the 'Cleaning care instructions' section of this User guide for your particular model for further information.**

Disposal

- **Extreme care must be taken when disposing of your old appliance to avoid hazards:**
 - **The flammable refrigerant gas must be safely removed.**
 - **The thermal insulation foam in this appliance contains flammable insulation blowing gases, any exposed foam may be highly flammable and must be carefully treated during disposal.**
 - **The doors and panels should be removed and the shelves left in place so that children may not easily climb inside.**
- **Your Fisher & Paykel trained and supported service technician will be able to give advice on environmentally friendly methods of disposing of your old refrigerator or freezer.**

Storing food and drinks

- **Do not store explosive substances such as aerosol cans with a flammable propellant in this appliance.**
- **Never store volatile or flammable materials in your refrigerator as they may explode.**
- **Never freeze liquids in glass containers. Liquid expands during freezing, which may cause the container to explode.**
- **Never freeze carbonated drinks. They may explode.**
- **Do not consume food if it is too cold. Food removed from the freezer compartment may be cold enough to cause damage when brought into contact with bare skin, eg frozen ice cubes.**

Power failure — food safety

- **Do not refreeze frozen foods that have thawed completely. The food may be dangerous to eat. Follow the recommendations below if you discover food in your freezer has thawed:**
 - **Ice crystals still visible — food may be refrozen but should be stored for a shorter period than recommended.**
 - **Thawed but refrigerator cold — refreezing generally not recommended. Fruits and some cooked food can be refrozen but use as soon as possible. Meat, fish, poultry — use immediately or cook then refreeze. Vegetables — discard as they usually go limp and soggy.**
 - **Thawed and warmer than 5°C — discard all food.**

INSTALLATION INSTRUCTIONS

Please follow the installation steps below to ensure your appliance operates correctly.

1. Power

- The appliance must be installed so the plug is accessible.
- To ensure that the appliance is not accidentally switched off, connect your refrigerator to its own power point. Do not plug in any other appliance at this power point or use extension cords and double adaptors, as the combined weight of both power cords can pull the double adaptor from a wall outlet socket.
- For power requirements, refer to the information on the serial plate located at the front bottom right-hand-side of the refrigerator when the door is open.
- It is essential that the appliance is properly grounded (earthed).

2. Location

- Your refrigerator should not be located in direct sunlight or next to any heat generating appliance such as a cooktop, oven or dishwasher.

INSTALLATION INSTRUCTIONS

3. Product and cabinetry dimensions

If integrating your refrigerator, please follow installation instructions provided with the integration kits.

E373, E450, E308, E388, E415H, E521T, RF331T, RF381T, RF411T, RF440T, RF521T

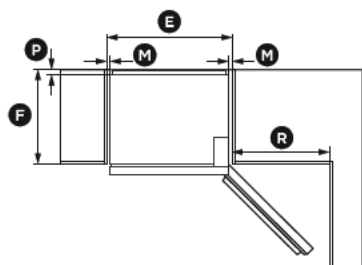
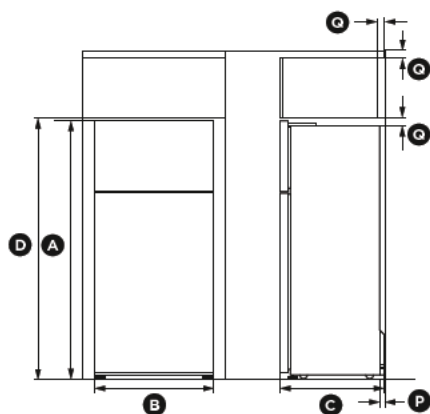

Flush with refrigerator chassis – full door rotation

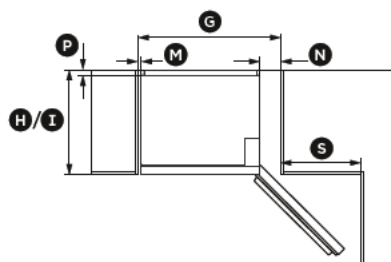

Flush with refrigerator door – full door rotation

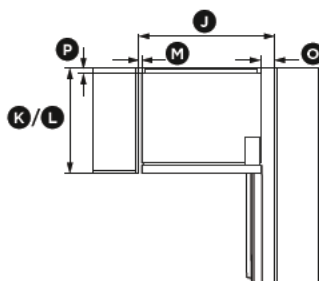

Flush with refrigerator door – 90° door rotation

INSTALLATION INSTRUCTIONS

	E373 E308	E450 E388	RF331T	RF381T	RF411T E415H	RF440T	RF521T	ES21T
PRODUCT DIMENSIONS								mm
(A) Overall height of curved door product	1425	1695	-	-	-	-	-	-
(A) Overall height of flat door product	-	1695	1450	1620	1720	1720	1720	1720
(B) Overall width of product	635	635	635	635	635	680	790	790
(C) Overall depth of curved door product (excludes handle, includes evaporator)	715	715	-	-	-	-	-	-
(C) Overall depth of flat door product (excludes handle, includes evaporator)	-	695	695	695	695	695	695	695
CABINERY DIMENSIONS (including minimum clearances)								mm
(D) Inside height of cavity	1475	1735	1465	1635	1735	1735	1735	1735
Flush with refrigerator chassis – full door rotation								
(E) Inside width	675	675	675	675	675	720	830	830
(F) Inside depth	620	620	620	620	620	620	620	620
Flush with refrigerator door – full door rotation								
(G) Inside width	790	790	790	790	790	835	945	945
(H) Inside depth flush to curved door	680	680	680	680	680	680	680	680
(I) Inside depth flush to flat door	-	695	695	695	695	695	695	695
Flush with refrigerator door – 90° door rotation (for full drawer/shelf access, the doors need to be open past 90°)								
(J) Inside width	745	745	745	745	745	790	900	900
(K) Inside depth flush to curved door	680	680	680	680	680	680	680	680
(L) Inside depth flush to flat door	-	695	695	695	695	695	695	695
MINIMUM CLEARANCES								mm
(M) Side clearance	20	20	20	20	20	20	20	20
(N) Side clearance – hinge side flush with door – full rotation	135	135	135	135	135	135	135	135
(O) Side clearance – hinge side flush with door – 90° rotation	90	90	90	90	90	90	90	90
(P) Rear clearance (including evaporator tray)	30	30	30	30	30	30	30	30
(Q) Vent (above refrigerator cabinet or around top of cupboard)	50	50	50	50	50	50	50	50
(R) Door clearance – hinge side flush with chassis – full rotation	520	520	520	520	520	555	645	645
(S) Door clearance – hinge side flush with door – full rotation	405	405	405	405	405	440	530	530

4. Installation

Your Fisher & Paykel refrigerator is fitted with front and rear rollers, designed for moving the product in the forwards and backwards direction.

Avoid moving the product in a sideways direction as this may damage the rollers or the floor covering/surface.

- (A) Your refrigerator will arrive with the front feet wound up making moving the product into its final location a simple task.
- (B) Roll the refrigerator into its final position making sure there is the correct air gap between the product and surrounding cabinetry. See minimum clearance in cabinetry dimensions table.
- (C) Adjust the front feet down until the refrigerator is leaning backward with the front approximately 10mm higher than the back. This will ensure a good door closing action.
- (D) Aligning your refrigerator with cabinetry.
- Align the sides of the refrigerator with the cabinetry by adjusting the hinge side front foot.
 - Adjust the handle side foot until it touches the floor and takes a small amount of weight.
 - Once the refrigerator is in place and aligned with cupboards/alcove gently push on the front top and check if the product is rocking or stable.

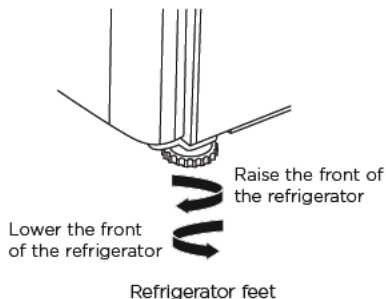

INSTALLATION INSTRUCTIONS

5. What to do if your product is unstable

- (A) Gently push the refrigerator back until the rear rollers contact the floor.
- Measure the gap under the front foot, which has come off the floor.
 - Obtain some solid packing material (hardwood, plastic, etc) which fits firmly into the gap under the foot.

Note: do not use metallic materials that may corrode, stain and/or damage floor coverings.

- (B) Wind both front feet up and roll the product out of position.
- Place the packing material in the location diagonally opposite the front roller that lifts off the floor.
 - Make sure the packing material stays in place when the product is pushed back into position.
 - Ideally, the packing material is large enough to rest against the back wall so as to prevent it from moving when the cabinet is pushed into position.

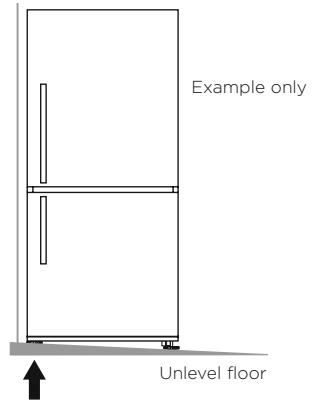

This foot lifts off the floor when top front is gently pushed back

Unstable refrigerator

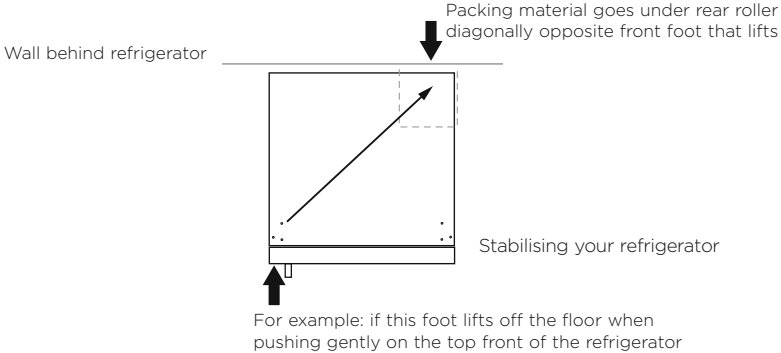

- (C) Roll the refrigerator back into position and adjust front feet as per step 4(C). (Check alignment and door closing action are satisfactory).
- Make small adjustments to front feet where necessary.
 - Check that the product is stable (all 4 feet are on the floor). If not, repeat 5(A) and 5(B).

INSTALLATION INSTRUCTIONS

Before placing food in the fresh food or freezer compartments

- Remove all internal packaging. Ensure that all transit clips are removed from the refrigerator. These are small rubber stoppers located at the back of the shelves.
- Clean the inside of the appliance with a mix of warm water and a small amount of liquid detergent, and a soft cloth to remove manufacturing and transportation dust.
- Allow the refrigerator and freezer to run empty for 2–3 hours to allow each compartment to cool to the appropriate temperature.
- The appliance may have an odour on its initial operation, but this will go when the refrigerator and freezer have cooled sufficiently.

Energy efficiency

For the most energy efficient use of your appliance:

- Ensure your refrigerator has adequate ventilation.
- Do not cover your appliance with any material that will prevent air from flowing around the cabinet sides.
- Ensure you vacuum around the appliance to remove dust and possible pet hair accumulation. Also keep the appliance and its cabinetry free of dust by wiping down with a dry, lint-free cloth (refer to sections 'Cleaning care instructions', 'Cabinet surround' for your specific model).
- Allow good clearances in front of air ducts within the cabinet for maximum cold air distribution.
- Cool hot foods down before placing them in the appliance.
- Do not overfill the compartments.
- Keep door openings to a minimum.
- Select a temperature setting that isn't too cold.
- Check your door seals for leaks.

MOVING OR STORING YOUR APPLIANCE

If your refrigerator is turned off for any reason, wait 10 minutes before turning it back on. This will allow the refrigeration system pressures to equalise before restarting.

Moving your refrigerator

- Turn off the appliance and unplug from the power point. Remove all food.
- Turn the adjustable feet to the right as far as they will turn.
- Ease the refrigerator out of its position. Tuck the power cord away, tape the shelves in place and tape the doors closed. If the cabinet needs to be placed at an angle or laid down, carefully lay it on its side (the right hand side when viewed from the front).
- Relocate and install. If the appliance has been left on its side for any length of time, leave it standing upright as long as you can (a few hours) before turning on.

Storing your refrigerator

- When storing your cleaned appliance, leave the doors open. This allows air to circulate and prevents the build up of bacteria and moulds.
- Before using again, clean well using a mixture of warm water and a small amount of liquid dishwashing detergent. Rinse with clean water and dry with a soft lint-free cloth.

Holiday time

We recommend you leave your refrigerator operating while you are on holiday.

ACTIVSMART™ OPERATING INSTRUCTIONS

Models:	635mm wide	RF331T, RF381T, RF411T, E415H
	680mm wide	RF440T
	790mm wide	E521T, RF521T

The control panel enables you to view and modify features and options on your refrigerator.

Temperature control

- When the refrigerator is first turned on, the powerful cooling system will automatically cool both refrigerator and freezer compartments to their set temperatures. This will take between 2 - 3 hours.
- The two compartment temperatures are accurately and independently controlled and do not change with the temperature or humidity of the surroundings; whether summer or winter.
- If you wish to alter the temperature of either the fresh food compartment or freezer compartment, this can be easily done by using the internal control panel located on the back wall of the refrigerator compartment.

Control panel (to adjust temperatures)

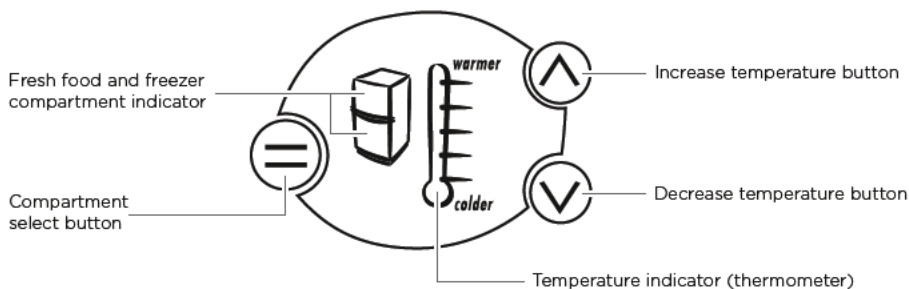

Fresh food compartment

- The fresh food compartment light will automatically be illuminated. The temperature for this compartment will show as a series of lights.
- The temperature may be altered by pressing the \wedge or \vee buttons. One press on either of these buttons will reduce or increase the number of lights by one which indicates a small change in temperature.
- Fewer lights illuminated means a cooler temperature for the compartment selected.

Freezer food compartment

- To adjust the freezer temperature press the **▬** button so the freezer compartment light is illuminated.
- The freezer temperature can be altered by pressing the **▲** or **▼** buttons.
- One press on either of these buttons will reduce or increase the number of lights illuminated which indicates a small change in temperature.
- Fewer lights illuminated means a cooler temperature for the compartment selected. Note: successively pressing the **▬** button will automatically scroll between the compartments.
- When the door is re-opened the control panel will return automatically to the fresh food compartment setting.

Door alarms

- If the fresh food compartment door is left open the alarm will beep after 90 seconds and if the freezer door is left open the alarm will beep after 60 seconds.
- While either door remains open, subsequent beeps will sound every 30 seconds for 5 minutes.
- A continuous alarm will sound if either of the doors have been left open for 5 minutes or longer and the interior compartment light(s) will turn off. The alarm will stop only when the door(s) is closed.

Sabbath mode

- To activate Sabbath mode, open both the fresh food and freezer compartment doors and then hold the **▬** button on the temperature control panel for 10 seconds.
- Both the fresh food and freezer compartment indicators will be illuminated indicating the refrigerator is in Sabbath mode.

When the product is in Sabbath mode:

- The fresh food and freezer compartment indicator lights will be illuminated.
- The light will not operate when the door is opened.
- The door alarm will not operate.
- The display will not function except to indicate Sabbath mode is active as stated above.
- Opening the door will not affect the compressor or fans.
- If the power to the refrigerator is turned off whilst in this mode, the product will continue in Sabbath mode when the power is restored.
- Sabbath mode will automatically de-activate 80 hours after activation.
- To de-activate earlier than 80 hours hold the **▬** button on the temperature control panel for 10 seconds.

Manual ice system (selected models only)

An ice storage bin which sits inside the upper top freezer bin provides storage for and gives you access to clean, clear ice cubes.

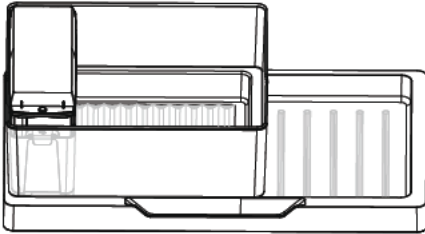

Upper left freezer bin, ice storage bin, ice tray, lid and scoop in correct position

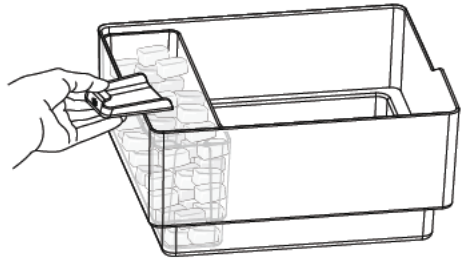

Accessing your ice

Information about your manual ice system

- To make ice, take the ice tray and lid from the top of the ice storage bin. Remove the lid from the ice tray and fill the tray with water. Place the lid back on the ice tray and carefully position it back onto the ice storage bin.
- Once the ice is solid, take the ice tray and lid off the ice storage bin, remove the lid from the tray and twist the ice tray at each end in opposite directions. Turn the ice tray over the ice storage bin to dislodge the cubes into the bin.
- Fill the ice tray with clean water and repeat to fill the ice storage bin.
- Attached to the ice storage bin is the ice scoop which provides hygienic access to ice.
- To access ice cubes, take the ice tray and lid from the top of the ice storage bin and place onto a flat surface. Take the scoop from the front of the bin, scoop cubes into vessel and then replace the scoop, tray and lid back to the top of the bin.
- For maximum ice storage, level the stored cubes around the bin with the ice scoop.
- If ice is not used often, old cubes will become cloudy, taste stale, will shrink and may stick together. Empty the ice storage bin periodically and wash in lukewarm water. Dry thoroughly and place back in the correct position.

Fruit and vegetable bins and humidity control lid

The fruit and vegetable bins feature a unique lid which provides two functions:

- The humidity lid seals the bins and provides a humid microclimate to extend storage times of fruit and vegetables.
- The humidity lid prevents condensation, which forms at high humidities, from dripping down onto the fruit and vegetables by retaining it in the grooves of the lid.

Fruit and vegetable bins and humidity slide (selected models only)

- Each fruit and vegetable bin has a humidity slide control that can be adjusted to a fruit or vegetable setting depending on what is stored in the bins.
- If possible try to store fruit and vegetables separately. This will help extend their storage life.
- If there is a mixture of fruit and vegetables in the bin adjust the position of the control to the centre.
- If there is too much water in the bins (due to the high humidity in the bins), the control can be adjusted towards the setting with fewer drips (fruit setting) and/or the water can be wiped out as required.
- Remember a minimum amount of water in the bins is beneficial for fruit and vegetable storage.

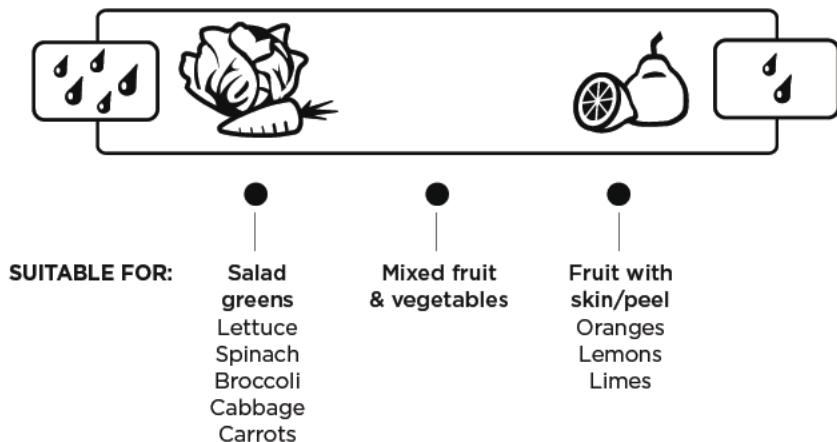

Humidity control graphic

Vegetable bin divider instructions (where fitted)

To fit the divider, insert divider into bin on an angle, straighten and slot into place. To adjust the divider, fully extend the bin, partially lift the divider, slide sideways and re-slot into position.

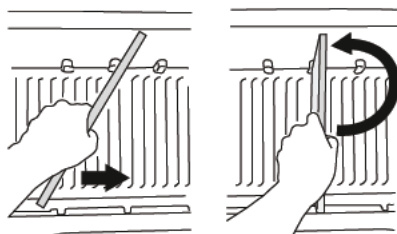

Vegetable bin divider

Bottle holder (where fitted)

- The bottle holders can be used to store a variety of bottles.
- To position the bottle holder in your refrigerator, simply slot the back edge of the bottle holder onto the back trim of any shelf in the fresh food compartment.
- If you are not using all or some of the bottle holders, the unused bottle holders can be stacked up on top of one another so they do not take up unnecessary shelf space.
- Bottles are best stored with the neck of the beverage facing the front of the refrigerator.

Glass shelves

- Glass shelves can be repositioned in the cabinet as desired.
- Remove shelves by lifting up the back of the shelf and then pulling the shelf forward.

Roll out drawer (E415H model)

- The roll out drawer is suitable for storing fruits and vegetables as well as tall bottles and drinks.
- A vent/baffle is located at the front of the drawer.
- The temperature in the drawer can be adjusted by opening or closing this vent.
- Opening the vent fully allows more cold air into the drawer. Typical operating temperatures in this compartment are from 3°C to 9°C.
- The closed vent situation is ideal for storage of tomatoes, tropical fruit, cucumber, capsicum, etc as these foods do not keep as well at colder temperatures.
- The open vent situation is suitable for most vegetables and fruits. Uncut fruit and vegetables with protective skin (eg apples and pears) can be stored without wrapping.
- To extend the storage life of other fruit and vegetables place them in loosely sealed plastic bags. This will reduce moisture loss and prevent excess moisture build-up.

Exterior

Stainless exterior doors

- Clean the exterior door with liquid dishwashing detergent dissolved in warm water and a soft cloth.
- Dry the door with a lint-free cloth.
- The use of any abrasive or stainless steel cleaners and solvents will damage the door surface.

Other exterior surfaces

- Clean all other exterior surfaces with a mix of warm water and liquid dishwashing detergent, and a soft cloth.
- If necessary, clean the magnetic door gasket, the centre door gasket and the recessed handles with an old toothbrush, warm water and liquid dishwashing detergent.

Cabinet surround

- To maximise operating efficiency regularly vacuum the flooring around your appliance.
- Cleaning behind the appliance is required once or twice a year. More frequent cleaning may be necessary for dusty homes or those with pets shedding hair.
- To do this wind up the feet and carefully ease the refrigerator out of its position. Switch off and unplug.
- Vacuum the flooring behind your appliance to remove dust accumulation. Use a dry lint-free cloth to clean the appliance walls and surrounding cabinetry.
- After cleaning, plug in and switch on. Push the appliance into position and wind feet down.

WARNING!

Electric Shock Hazard. Do not remove rear compartment cover. This may expose you to the risk of an electric shock.

Water evaporator tray

- The water evaporator tray is found above the compressor at the back of the refrigerator or freezer. The tray may require infrequent cleaning.
- Carefully move the refrigerator or freezer out from the wall.
- Switch off the appliance.
- We do not recommend that you remove the evaporator tray. If cleaning is required, excess water can be soaked up from the evaporator tray using a sponge. Wipe out with warm water and detergent or disinfectant.
- Switch on the appliance and reposition the refrigerator.

Interior

- It is important to keep the interior of the refrigerator and freezer clean to help prevent food from becoming contaminated during storage.
- The amount and types of food stored determines how often cleaning should be carried out in the refrigerator (ideally once every 1-2 weeks).
- Remove the shelves from cabinet and door. Wash shelves and storage bins in warm water and detergent; rinse in clean water and dry before replacing.
- Wipe over the interior surfaces with warm water and liquid dishwashing detergent. Alternatively you can use 1tsp baking soda dissolved in 500ml of warm water. Rinse with clean water.
- To help remove “old stale refrigerator” smells add a few drops of vanilla essence or vinegar to the water before cleaning.
- Clean interior surfaces with warm water and liquid dishwashing detergent. Use a toothbrush for the magnetic door gasket.
- Do not use harsh, abrasive cloths on any part of the refrigerator or freezer.

Glass shelves

Clean with warm water and detergent or a glass cleaner.

Bottle holder (where fitted)

Clean with warm water and detergent. The use of abrasive cleaners and solvents may cause damage.

IMPORTANT!

Many commercially available cleaning products contain solvents that may attack the plastic components of your refrigerator and cause them to crack. It is important to use only warm water and a small amount of liquid dishwashing detergent on any components inside and outside your refrigerator. Avoid using anti-bacterial cleaning products on either the interior or exterior of the cabinet as they may cause rusting of metal components and cracking of plastic components.

Humidity Control System (where fitted)

IMPORTANT!

When cleaning the shelf above the vegetable bins, we recommend that you do not disassemble the Humidity Control System from the shelf.

In the event that the humidity control lid (plastic lid) and humidity slides become separated from the glass shelf, follow these instructions to reassemble.

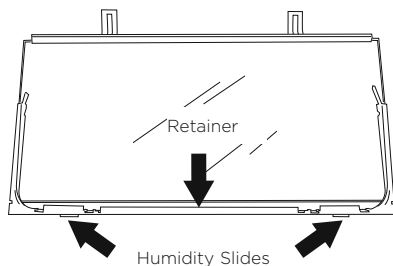

- 1 Turn shelf upside down.
- 2 To attach humidity slides onto shelf front corners, fit bottom clips into shelf front trim. Next, slide sideways towards shelf until arm clips onto glass.

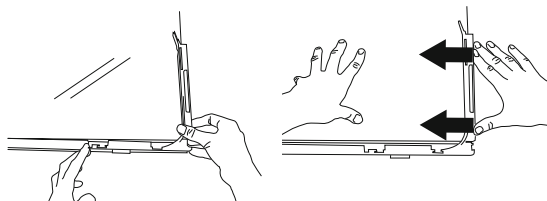

- 3 To attach humidity control lid—with text facing you, align lid with front of shelf. Hold lid vertically and fit front end into retainer on shelf. Ensure lid fits into retainer as well as underneath humidity slides.



- 4 At the sides of the shelf, adjust humidity slide tabs so that the plastic lid is between the shelf and the tabs.
- 5 If clips on back of shelf are present, fasten lid with rear clips. Ensure that the cover is fully secure at front and back of shelf.

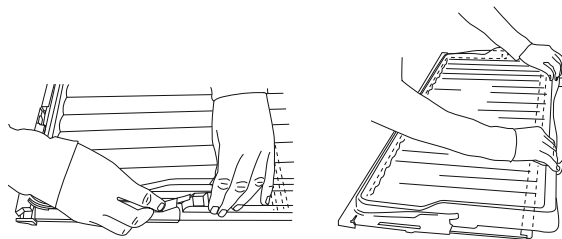

Humidity Control System cleaning

ACTIVSMART™ CLEANING CARE INSTRUCTIONS

To remove trays or fixed bins (selected ActiveSmart™ models only)

- For ease of removal, empty food from tray/bin first.
- Hold the centre front of the tray/bin handle.
- Lift vertically to unclip from the runners and pull tray/bin towards you to remove.
- Push both runners back into refrigerator.

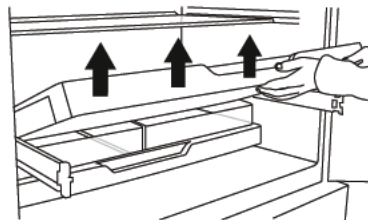

Tray removal

To replace trays or fixed bins

With the runners pushed back into the refrigerator, place the tray/bin on top of the runners. Push the tray/bin back slowly until you feel it clip back onto the runners.

Roll out fruit and vegetable bin (E415H model)

- Remove for cleaning by pulling out the compartment until it stops, lifting and then continuing to slide it forward until it is fully extended.
- Rest the door front on the floor and with the refrigerator compartment door open, remove the tray, divider rack and bin. Wash with warm water and detergent.
- Rinse, dry and replace.

Lower shelf in models with roll out fruit and vegetable bin (E415H model)

- Remove the front baffle after lifting its inner edge. With the refrigerator compartment door open, slide the shelf forward and lift out. Clean with warm water and detergent.
- Rinse, dry and replace in the second groove up from the side runner rail.



Front baffle

IMPORTANT!

- **Ensure that trays and bins are securely clipped onto the runners before use.**
- **Bin and tray runners are pre-lubricated, and will not need to be re-lubricated during their life. Do not attempt to clean grease from the runners, as this will affect their ability to function. Do not immerse runners in water.**

On vacation/holiday

We recommend you leave your refrigerator or freezer operating while you are on holiday.

User warnings

Fault alarms

- If the electronic controller detects a fault from which it is unable to recover an alarm will sound.
- When the fresh food compartment door is opened a fault code (specific pattern of lights) will flash red and green on the control panel to alert you to the fault. The audible alarm will stop when any button is pressed but the lights will remain flashing. If such a fault occurs, call your Fisher & Paykel trained and supported service technician immediately; the fault code will help the service person find and remedy the cause of failure.

Normal refrigerator sounds

ActiveSmart™ refrigerators, with their excellent energy ratings and cooling performance, can produce sounds somewhat different to your old refrigerator.

Normal operational sounds include:

- Fan air flow sound. ActiveSmart™ refrigerators have fans which change speed depending on demand. During cooling periods, such as after frequent door openings, fans circulate the cold air in the refrigerator and freezer compartments producing some air flow sound. This is quite normal.
- Cracking or popping which may occur when the defrost function is operating.
- Running water sound. This is the liquid refrigerant in the system and can be heard as a boiling or gurgling noise.
- An audible hissing sound after closing the freezer door. This is due to the pressure difference between the warm air that has entered the cabinet and suddenly cooled, and the outside air pressure.
- Other sounds may be heard for the following reasons:
 - Cabinet not level.
 - Floor uneven or weak.
 - Bottles or jars rattling on shelves.

VERTICAL REFRIGERATOR OPERATING INSTRUCTIONS

Models: 635 mm wide E373, E450

Temperature control

- The control has been factory set for normal operating conditions.
- Allow the refrigerator to run empty for 2–3 hours before placing food inside the fresh food or freezer compartments.
- Re-adjust the control as necessary to suit your individual preference.

1 is warmest setting

7 is coldest setting

- We recommend adjusting the temperature by half a setting initially and then allow at least 24 hours for the cabinet temperature to stabilise before re-adjusting.
- If you are altering the temperature of a 2-door refrigerator, remember you are altering the temperature of both compartments.
- The running time and temperature are affected by where your refrigerator is located, how often the door is opened and the temperature of the room the refrigerator is located in. Your refrigerator is designed to operate in a room temperature of between 10°C and 43°C.

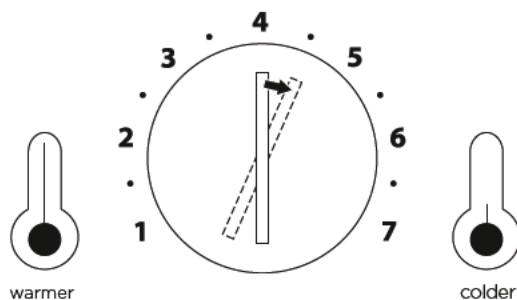

VERTICAL REFRIGERATOR SPECIAL FEATURES AND MAINTENANCE

Door alarms

- If the fresh food compartment door is left open the alarm will beep after 90 seconds.
- If the door remains open, subsequent beeps will sound every 30 seconds for 5 minutes.
- A continuous alarm will sound if the door has been left open for 5 minutes or longer.
- The alarm will stop when the door is closed.

Fault alarms

- If the electronic controller detects a fault from which it is unable to recover, an alarm will sound when the door is opened.
- When the fresh food compartment door is opened and a fault has occurred, a specific number of beeps will sound. If a fault occurs, call your Fisher & Paykel trained and supported service technician immediately; the number of beeps will help the service person find and remedy the cause of failure.

Humidity control lid

The fruit and vegetable bins feature a unique lid which provides two functions:

- The humidity control lid seals the bins to provide a humid microclimate to extend storage times of fruits and vegetables.
- The humidity control lid prevents condensation, which forms at high humidities, from dripping down onto the fruit and vegetables by retaining it in the grooves of the lid.

The ability to retain high humidity in the fruit and vegetable bin may produce small amounts of water in the bottom of the fruit and vegetable bin. This can be wiped out as required.

Replacement of interior light

- Turn the power off at the wall before replacing the LED lamp.
- The interior lamp is located on the right-hand side of the temperature control box and is removed by sliding the cover outward.
- Replace lamp, making sure it is tightly pushed in. Switch the power back on.
- The replacement lamp must not exceed 2.5 Watts. Lamps are available from your Fisher & Paykel trained and supported service technician or through the Customer Care Centre.

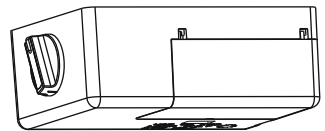

IMPORTANT!

Your refrigerator is designed to operate for many years without the need for frequent service checks. However, if your refrigerator is malfunctioning, have it attended to by your Fisher & Paykel trained and supported service technician as soon as possible. All electrical repairs must be carried out by an adequately trained service technician or qualified electrician.

VERTICAL FREEZER OPERATING INSTRUCTIONS

Models: 635mm wide E308, E388

Temperature control

- The cabinet control is located at the bottom rear of the cabinet.
- The control has been factory set to position "4" for normal operating conditions.
- The freezer temperature should be approximately -18°C.
- Re-adjust the control as necessary to suit your individual preference.

1 is the warmest setting.
7 is the coldest setting.

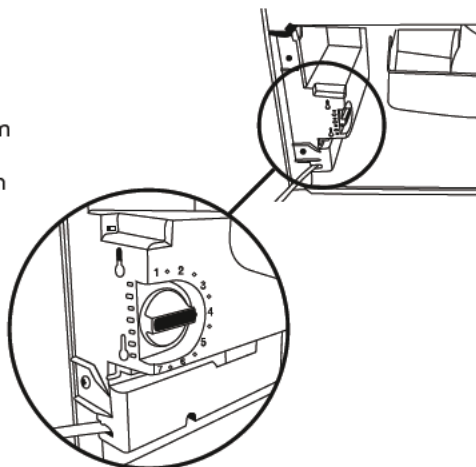

Door alarms

- If the door is left open the alarm will beep after 60 seconds.
- If the door remains open, subsequent beeps will sound every 30 seconds for 5 minutes.
- A continuous alarm will sound if the door has been left open for 5 minutes or longer.
- The alarm will stop when the door is closed.

Fault alarms

- If the electronic controller detects a fault from which it is unable to recover, an alarm will sound when the door is opened.
- When the door is opened and a fault has occurred, a specific number of beeps will sound. If a fault occurs, call your Fisher & Paykel trained and supported service technician immediately; the number of beeps will help the service person find and remedy the cause of failure.

VERTICAL REFRIGERATOR AND VERTICAL FREEZER CLEANING CARE INSTRUCTIONS

WARNING!

To avoid electric shock always unplug your refrigerator/freezer before cleaning. Ignoring this warning may result in death or injury.

Exterior

Stainless exterior door

- It is important when cleaning the exterior door surface of your appliance, to only use liquid dishwashing detergent dissolved in warm water.
- Dry the door with a clean, lint free cloth.
- The use of any abrasive or stainless steel cleaners and solvents will damage the door surface.
- Caution: jewellery can damage clear coat on door surface.
- Other exterior surfaces
- Clean all other exterior surfaces with warm water and detergent.
- If necessary, clean the magnetic door gasket with an old toothbrush, warm water and detergent.

Cabinet surround

- To maximise operating efficiency regularly vacuum the flooring around your appliance.
- Cleaning behind the appliance is required once or twice a year. More frequent cleaning may be necessary for dusty homes or those with pets shedding hair.
- To do this switch off and unplug the appliance and pull the appliance out from the wall.
- Vacuum the flooring behind your appliance to remove dust accumulation. Use a dry lint-free cloth to clean the appliance walls and surrounding cabinetry.
- After cleaning, plug in and switch on. Push the appliance into position.
- Water evaporator tray
- The water evaporator tray is found above the compressor at the back of the refrigerator or freezer. The tray may require infrequent cleaning.
- Carefully move the refrigerator or freezer out from the wall. Switch off the appliance.
- We do not recommend that you remove the evaporator tray. If cleaning is required, excess water can be soaked up from the evaporator tray using a sponge. Wipe out with warm water and detergent or disinfectant.
- Switch on the appliance.

VERTICAL REFRIGERATOR AND VERTICAL FREEZER CLEANING CARE INSTRUCTIONS

WARNING!

To avoid electric shock always unplug your refrigerator/freezer before cleaning. Ignoring this warning may result in death or injury.

Interior

- It is important to keep the interior of the refrigerator and freezer clean to help prevent food from becoming contaminated during storage.
- The amount and types of food stored determines how often cleaning should be carried out.
- For refrigerator models, remove the shelves from cabinet and door. Wash shelves and storage bins in warm water and detergent; rinse in clean water and dry before replacing.
- For freezer models, remove the baskets from the cabinet. Wash in warm water and detergent; rinse in clean water and dry before replacing.
- Wipe over the interior surfaces with warm water and liquid dishwashing detergent. Alternatively you can use 1tsp baking soda dissolved in 500ml of warm water. Rinse with clean water. Use a toothbrush to clean the door gasket.
- To help remove “old stale” smells add a few drops of vanilla essence or vinegar to the water before cleaning.
- Do not use harsh, abrasive cloths or cleaners on any part of the appliance.

IMPORTANT!

Many commercially available cleaning products contain solvents that may attack the plastic components of your appliance and cause them to crack. It is important to use only warm water and a small amount of liquid dishwashing detergent on any components inside and outside your appliance. Avoid using anti-bacterial cleaning products on either the interior or exterior of the cabinet as they may cause rusting of metal components and cracking of plastic components.

Glass shelves (Vertical refrigerator models only)

Remove from refrigerator and clean with warm water and detergent or a glass cleaner.

IMPORTANT!

If cleaning the shelves without removing from the cabinet use only warm water and detergent as a glass cleaner can damage the plastic components of your refrigerator.

Fruit and vegetable bin(s) and lid (vertical refrigerator models only)

- When cleaning the glass shelf above the produce bins, we recommend using only liquid dishwashing detergent dissolved in warm water and a soft lint-free cloth.
- Rinse with clean water and dry with a clean, lint-free cloth.
- When cleaning the humidity control lid (attached to the underside of the glass shelf), we do not recommend disassembling the parts. To clean, simply wipe the grooves of the lid with a damp, lint-free cloth.

STORING FOOD IN YOUR REFRIGERATOR

Your refrigerator helps to extend the storage times of fresh perishable foods. The cold temperature slows down the major causes of food spoilage – namely, the growth of bacteria, moulds and yeasts, and any chemical and physical reactions.

Fresh food care

The quality of food before it is placed in the refrigerator is critical to successful storage. For best results:

- Select foods that are very fresh and of high quality.
- Buy only the amount that you will use within the recommended storage time. If you buy extra, plan to freeze it.
- Ensure that food is well wrapped or covered before it is stored. This will prevent food from dehydrating, deteriorating in colour or losing flavour and will help maintain freshness. It will also prevent odour transfer. Fruit and vegetables need not be wrapped provided they are stored in the vegetable bins of the refrigerator.
- Make sure that strong smelling foods are wrapped or covered and stored away from foods such as butter, milk and cream which can be easily tainted by strong odours.
- Refrigerate fresh, perishable foods as soon as possible after purchase. If left at room temperature for any length of time the rate of deterioration will be accelerated.
- Avoid placing food directly in front of air outlets, as it may freeze and cold air needs to circulate to maintain safe food storage.
- Do not open the refrigerator door unnecessarily.
- Cool hot foods down before placing them in the refrigerator. This should be done quickly. It can be aided by placing the container of food in a bowl of ice and water; renew the ice as necessary. (Note also that hot containers may damage shelves and walls of the refrigerator).
- Store raw and cooked food in separate containers or packaging to prevent cross contamination.

In addition:

- Keep the refrigerator clean. Wipe the inside walls and shelves frequently (refer to section 'Cleaning care instructions' for your specific model) and place only clean containers in the refrigerator.
- Keep a close check on the quality of food in your refrigerator. Discard any food that shows signs of spoilage. Pay particular attention to meat, fish and poultry, as these foods are highly perishable. Use food within the recommended storage times.

Dairy foods and eggs

- Most pre-packed dairy foods have a recommended 'use by/best before/best by' date stamped on them. Store them in the refrigerator and use within the recommended time.
- Butter can become easily tainted by strong smelling foods so it is best stored in a sealed container.
- Eggs should be stored in the refrigerator. For best results, especially when baking, remove the eggs from the refrigerator two hours before they are to be used.

STORING FOOD IN YOUR REFRIGERATOR

Red meat

- Place fresh red meat on a plate and loosely cover with waxed paper, plastic wrap or foil.
- Store cooked and raw meat on separate plates. This will prevent any juices lost from the raw meat contaminating the cooked product.
- Delicatessen meats should be used within the recommended storage time.

Poultry

- Fresh whole birds should be rinsed inside and out with cold running water. Dry and place on a plate. Cover loosely with plastic wrap or foil.
- Poultry pieces should also be stored this way. Whole poultry should never be stuffed until just before cooking, otherwise food poisoning may result.
- Cool and refrigerate cooked poultry quickly. Remove stuffing from poultry and store separately.

Fish and seafood

- Whole fish and fillets should be used on the day of purchase. Until required, refrigerate on a plate loosely covered with plastic wrap, waxed paper or foil.
- If storing overnight or longer, take particular care to select very fresh fish. Whole fish should be rinsed in cold water to remove loose scales and dirt and then patted dry with paper towels. Place whole fish or fillets in a sealed plastic bag.
- Keep shellfish chilled at all times. Use within 1–2 days.

Precooked foods and leftovers

- These should be stored in suitable covered containers so that the food will not dry out.
- Keep for only 1–2 days.
- Reheat leftovers only once and until steaming hot.

Fruit and vegetable bins

- Although most fruit and vegetables keep best at low temperatures, take care not to store the following at temperatures of less than 7°C for long periods: Citrus fruit, tropical fruit, tomatoes, cucumbers.
- Undesirable changes will occur at low temperatures such as softening of the flesh, browning, accelerated decaying and/or loss of flavour.
- Do not refrigerate avocados (until they are ripe), bananas, mangoes or pepinos.
- If possible store fruit and vegetables separately, ie fruit in one bin and vegetables in the other.
- Each fruit and vegetable bin has a humidity control slide that can be adjusted depending on what is stored in the bins. For more information on using the Humidity Control refer to section 'ActiveSmart™ special features'.

STORING FOOD IN YOUR FREEZER

The use of temperatures of -18°C or colder to store food means that the food can be kept for longer periods than when refrigeration temperatures are used. This is because the growth of bacteria, moulds and yeasts are stopped, and chemical and physical reactions are severely restricted at such low temperatures.

Frozen food care

For best results:

- Choose only high quality foods that freeze well.
- Store at -18°C or colder. Take care to maintain this low storage temperature, eg try to avoid opening the freezer door unnecessarily. If your ice cream is soft you are running your freezer too warm.
- Leave space at the top of containers, glass jars or plastic bags containing liquids or semi-solid foods. These expand as they freeze. Usually 20 - 50mm head space is recommended. Seal. Ideally, remove all the air from the package after food is frozen.
- Packages or containers of solid foods should have the air removed from them and be sealed tightly before freezing.
- Use the 'Fast Freeze' function when freezing fresh food. This helps to speed up the freezing process, giving optimum freezing results. It is recommended that the function is activated approximately 2 hours before required.
- Freeze immediately or as quickly as possible. Freeze only small quantities of food at any one time. For best results we recommend that only 1kg of food be frozen per 25L of freezer storage volume at any one time. (About 3kg in small freezers and 4kg in larger freezers). For faster freezing in ActiveSmart™ models, we recommend that fresh food is placed at the top of the freezer compartment close to the air vent.
- Thaw foods preferably in a refrigerator, or using a microwave oven or multifunction oven.
- Keep a constant turnover of food. Use older items of food first and do not exceed recommended storage times.
- Use good quality freezer proof packaging to maintain food quality.
- If food is only covered in plastic film place inside a freezer-proof plastic bag.

Recommended freezer storage times

These times should not be exceeded.

MONTHS	TYPE OF FOOD STORED
1	Bacon, casseroles, milk
2	Bread, ice cream, sausages, pies – (meat and fruit), prepared shellfish, oily fish
3	Non-oily fish, shellfish, pizza, scones and muffins
4	Ham, cakes, biscuits, beef and lamb chops, poultry pieces
6	Butter, vegetables (blanched), eggs whole and yolks, cooked crayfish, minced meat (raw), pork (raw)
12	Fruit (dry or in syrup), egg whites, beef (raw), whole chicken, lamb (raw), fruit cakes

STORING FOOD IN YOUR FREEZER

Meat, poultry and game

- Do not try to freeze more than 1kg of meat per 25L of freezer storage volume at any one time. Meat must be frozen quickly in order to maintain its texture.
- Do not stuff poultry before freezing.
- Red meat can be cooked from frozen, or from the partly or completely thawed states. Remember to allow extra cooking time if cooking from frozen.
- Always thaw poultry completely before cooking.

Fish

- Fish is best frozen commercially. If, however, you do want to freeze fish at home, make sure the fish is very fresh and of high quality.
- Clean, scale and preferably leave whole. All fish should be wrapped in two layers of packaging as depending on the type of fish, odours and flavours can be readily transferred either to or from it. Seal well.
- For best results, cook from either the frozen or partly thawed state.

Fruit

- Choose high quality, mature, and ready to eat fruit. Preferably select varieties recommended for freezing.
- Avoid unripe and over-ripe fruit.
- The way fruit is packed depends on how it is to be used. Fruits packed in syrup are ideal for desserts, whereas fruits packed without sugar are better used for cooking. Most fruits can be stored for 8–12 months.

Vegetables

- Most vegetables freeze well, although 'salad' vegetables lose their crispness. Other vegetables, eg celery, onion and tomatoes, should only be used in cooked dishes as they soften on freezing.
- Freeze only high quality, mature, ready-to-eat vegetables.
- Sort and discard any vegetables that are damaged.
- It is necessary to blanch most raw vegetables prior to freezing.
- Blanching involves a short cooking period during which vegetable enzymes are destroyed. If these enzymes are not destroyed they cause undesirable physical and chemical changes during freezer storage.
- Vegetables can be blanched in boiling water, steam or microwave oven. If using boiling water, boil vegetables for 2–4 minutes and cool quickly.
- In general, frozen vegetables are best cooked from their frozen state.

Prepared and cooked foods

- Most cooked foods can be frozen but it is not recommended to freeze the following: Cooked egg white, custards, cream fillings and milk puddings, gelatine or jelly-like dishes, mayonnaise and similar salad dressings, meringue toppings. These tend to separate on thawing.

TROUBLESHOOTING

If there is a problem with your appliance, please check the following points before contacting your local Fisher & Paykel trained and supported service technician or the Customer Care Centre.

Product parts and accessories can be purchased through Fisher & Paykel Customer Care Centre or online at fisherpaykel.com (this service is available to selected markets only).

All models

PROBLEM	POSSIBLE CAUSES	WHAT TO DO
Appliance does not operate	No electricity at power outlet.	Check that the plug is correctly connected and power switched on. Check another appliance at the same outlet. Check house fuse.
Motor operates for long periods	Hot weather. Frequent door openings. Large amount of food recently added. Temperature control set too low. Doors not sealing properly.	Minimise door openings to allow temperature to stabilise. Refer to section 'Temperature control' for your specific model. Check that cabinet is level and gasket seals are clean.
Storage compartments too warm	Temperature setting not correct. Frequent door openings. Large amount of food recently added.	Refer to section 'Temperature control' for your specific model. Minimise door openings to allow temperature to stabilise.
Food freezing in the refrigerator	Temperature setting not correct. Food placed directly in front of air outlets.	Refer to section 'Temperature control' for your specific model. Move chill sensitive foods away from the centre back of the shelves.
Unfamiliar noises	Cabinet not stable or level. Freezer is defrosting.	Refer to section 'Installation instructions' for your specific model. For ActiveSmart™ models refer to page 25.
Exterior of cabinet is warm	This is normal.	
Condensation on outside of refrigerator/freezer	Not unusual during periods of high humidity.	Wipe dry.

TROUBLESHOOTING

All models

PROBLEM	POSSIBLE CAUSES	WHAT TO DO
Door handles out of alignment	With time and usage, movement may occur.	Refer to section 'Installation instructions' for your specific model.
Appliance operating inefficiently	Accumulation of dust on or behind the rear compartment cover.	Refer to the section 'Cleaning care instructions' for your specific model. If problem persists please contact Customer Care.
Ice buildup inside freezer compartment	Freezer door not closing tightly.	Move items in freezer so door can close tightly. Check and clean door gasket seal.
Taste of odour in ice cubes	Transfer of odour/taste from strong smelling foods.	Wrap or cover strong smelling foods.

TROUBLESHOOTING

ActiveSmart™ models only

PROBLEM	POSSIBLE CAUSES	WHAT TO DO
Light not working	Light not functioning.	For ActiveSmart™ models, the light cannot be serviced by the user. Contact your Fisher & Paykel trained and supported service technician.
Light and display not working (ActiveSmart™ models)	Product in 'Sabbath mode'.	Press and hold  down for 10 seconds.
Unfamiliar noises	Cabinet not stable or level. Freezer is defrosting.	Refer to section 'ActiveSmart™ user warnings and sounds'.
Condensation inside fresh food compartment	Frequent or long door openings.	Minimise door openings.
	Door gasket leaking.	Check that gasket is sitting flat and sealing tightly.
Tray/bin does not slide in and out evenly	Not unusual during periods of high humidity.	Wipe dry.
	Packaging trapped.	Check to ensure no food or packaging is trapped behind the tray/bin.
	Runners not extending fully.	Holding onto sides of tray/bin, extend the runners fully by using a firm pull – this will reset the runner.

TROUBLESHOOTING

Vertical refrigerator models only

PROBLEM	POSSIBLE CAUSES	WHAT TO DO
Light not working	Light not functioning.	For Vertical refrigerator models – the light bulb has blown, replace bulb.
Water in the vegetable bins	Condensation is formed by the water produced by fruit and vegetables.	A small amount of condensation is beneficial for fruit and vegetable storage. Wipe out water with a cloth. Set humidity slide to low humidity setting 
Tray/bin does not slide in and out evenly	Packaging trapped. Runners not extending fully.	Check to ensure no food or packaging is trapped behind the tray/bin. Holding onto sides of tray/bin, extend the runners fully by using a firm pull – this will reset the runner.

SERVICE & WARRANTY

For details of your Manufacturer's Warranty and contacts for servicing, refer to your separate 'Service & Warranty' book provided with your refrigerator.

This product has been designed for use in a normal domestic (residential environment). This product is not designed for any commercial use. Any commercial use by the customer will affect this products manufacturer's warranty.

Complete and keep for safe reference:

Model _____

Serial No. _____

Purchase Date _____

Purchaser _____

Dealer _____

Suburb _____

Town _____

Country _____

EUROPEAN DIRECTIVE 2012/19/EU ON WASTE ELECTRICAL AND ELECTRONIC EQUIPMENT (WEEE)

GB This appliance is marked according to the European directive 2012/19/EU on Waste Electrical and Electronic Equipment (WEEE). By ensuring this product is disposed of correctly, you will help prevent potential negative consequences for the environment and human health, which could otherwise be caused by inappropriate handling of this product.

The symbol  marked on the serial plate, or on the documents accompanying the product, indicates that this appliance cannot be treated as household waste. It shall be handed over to the applicable collection point for the recycling of electrical and electronic equipment. Disposal of the appliance shall be carried out in accordance with the local environment regulations for waste disposal and ensure the refrigerant circuit is not damaged.

For more detailed information about treatment, recovery and recycling of this product, please contact your local city office, your household waste disposal service or your Fisher & Paykel retailer/dealer from whom you purchased this product.

FISHERPAYKEL.COM

© Fisher & Paykel Appliances 2018. All rights reserved.

The product specifications in this booklet apply to the specific products and models described at the date of issue. Under our policy of continuous product improvement, these specifications may change at any time. You should therefore check with your Dealer to ensure this booklet correctly describes the product currently available.

NZ AU GB IE EU AE CN HK SG

844938B 03.18