

Built-under Dishwasher, Sanitise

Series 7 | Contemporary

Black Stainless Steel



Offering a superior wash performance and advanced drying, this dishwasher is designed to fit flush under your benchtop for a seamless look.

- Designed to be built under your benchtop, fitting flush with cabinetry for a seamless look
- Seven wash programs from Heavy to Light, including Auto, 60min and Eco
- Dry+, Sanitise, Half Load and Intensive modifiers provide extra wash options

- Wi-Fi enabled and works with the SmartHQ™ app for remote control and notifications

DIMENSIONS

Height	820 - 880mm
Width	597mm
Depth	574mm

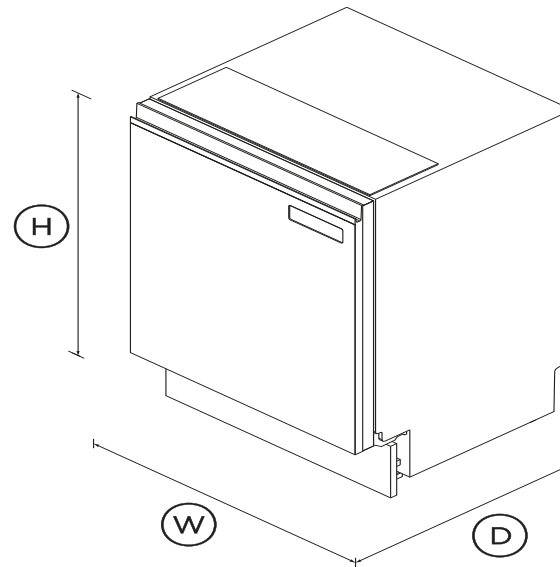

FEATURES & BENEFITS

Seamless Design

Install this dishwasher flush under your benchtop with minimal gaps. Designed to match our Contemporary family of appliances with a recessed handle for a seamless finish in your kitchen.

Advanced drying

For beautifully dry dishes every time, this dishwasher features an

advanced drying system. It combines fan-assisted drying with an automatic door opening at the cycle's end. The Auto Door Open Dry feature releases excess steam, ensuring dishes are immediately ready for use or storage. An innovative air curtain channels the steam away from the adjacent benchtop, protecting your cabinetry.

A Reliable Clean

This dishwasher offers seven wash programs including Auto, which automatically senses the optimal wash settings for your dishes. The three-stage filtration system delivers a superior clean, while the rinse aid indicator reminds you to top up for beautifully clean dishes.

Customise Your Wash

Create the perfect wash with our range of modifiers, from Intensive for a thorough clean to Half Load, ideal for a partial load. The Sanitise modifier provides extra protection, killing 99.9% of bacteria* in the final rinse, while Dry+ is great for plastic dishes. *Certified to NSF/ANSI Standard 184

Quiet Performer

Running at a very low decibel rating, this dishwasher does its job without making a fuss. The combination of clever technology and simple mechanics means greater reliability and superior wash performance, with minimal noise.

Efficient Performance

With a 4.5 star energy rating and 5.5 star water rating, this dishwasher delivers a powerful wash. Use the Eco wash program for optimal water and energy consumption, or choose when the cycle begins with Delay Start.

Flexible Loading

Designed to fit 15 place settings, this spacious model lets you stack large items with ease. Adjustable rack options provide flexibility for any load, with a full-width cutlery tray, height-adjustable middle rack, cup holders and wine glass supports.

SPECIFICATIONS

Accessories

- Cutlery basket •
- Kickstrip •

Capacity and loading

- Accommodates round plates **320mm**
- Accommodates round plates **200mm (with cutlery tray),**
- Adjustable height, foldable •
- Easy lift adjustable upper •
- Fold down tines •
- Full width cutlery/utensil tray •
- Large crockery insert in lower •
- Place settings **15**
- Wine glass supports with •

Consumption

- Energy rating **4.5 star**
- Energy usage **206 kWh/year**
- In-use energy carbon **27.9kgCO2e/year**
- Water consumption (per wash) **11.1L**
- Water efficiency **5.5 star (WELS)**

Controls

- Energy saving delay start •
- Internal light •
- Intuitive capacitive touch •
- Keylock •
- Rinse aid indicator light •
- Time remaining LED display •
- Wi-Fi connectivity •

Features

- Air curtain for bench •
- Aquastop •
- Auto Door Open Dry •
- Fan assisted drying •
- Flood protection •
- Fully independent spray arms •
- Half load option •
- Internal tub material **Stainless Steel**
- Motor type **BLDC**
- Three-stage filtration system •

Performance

- Noise emissions **42dBA**

Power requirements

- Amperage **10A**
- Supply frequency **50Hz**
- Supply voltage **220 - 240V**

Product dimensions

- Depth **574mm**
- Height **820 - 880mm**
- Width **597mm**

Warranty

- Parts and labour **2 years**

Wash Program Modifiers

- Dry + •
- Half-load •
- Intensive •
- Sanitise •
- Wash modifiers **4**

Wash Programs

- 60 min •
- Auto •
- Eco •
- Heavy •
- Light •
- Medium •
- Rinse •
- Wash programs **7**

Water connection

- Water pressure **30kPa - 1000 kPa**
- Water supply **3/4" BSP (20mm) Connector**

SKU **82435**

The product dimensions and specifications in this page apply to the specific product and model. Under our policy of continuous improvement, these dimensions and specifications may change at any time. You should therefore check with Fisher & Paykel's Customer Care Centre to ensure this page correctly describes the model currently available. Fisher & Paykel Appliances Ltd 2020







Where applicable:

All appliances use energy, and energy usage typically generates carbon emissions. **Fisher & Paykel Appliances' In-use Energy Carbon Emissions Estimate** indicates

carbon emissions from a product's in-use energy. This is calculated either annually or per cycle, using the product's market-specific energy label energy consumption data multiplied by the carbon emissions factor for energy in your country or region.

Our In-use Energy Carbon Emissions Estimate is designed to assist customers in making informed purchasing decisions when comparing different Fisher & Paykel products. For example, a heat pump dryer typically has a lower In-use Energy Carbon Emissions Estimate than a vented dryer.

Other product downloads available at fisherpaykel.com

-  [Service & Warranty](#)
-  [User Guide Dishwasher](#)
-  [Wash Program Data Dishwasher](#)
-  [Energy & Water Label Built-Under Dishwasher](#)
-  [Installation Guide Built-Under Dishwasher](#)
-  [Preliminary Specification Guide Dishwasher](#)
-  [Data Sheet Dishwasher](#)



A PEACE OF MIND SALE

24 Hours 7 Days a Week Customer Support

T 0800 372 273 W www.fisherpaykel.com