

60cm Series 9 Minimal Pyrolytic Oven

Minimal



A highlight of the Fisher & Paykel collection, this Minimal style oven with touchscreen guided cooking helps to ensure every dish is cooked to perfection.

- Touchscreen guided cooking capability offers helpful tips for different food types as well as full recipes
- 85L total capacity with 16 oven functions including Pastry Bake, Roast, Air Fry and Dehydrate
- Pyrolytic self-cleaning function breaks down food residue for an easy clean

DIMENSIONS

Height	598 mm
Width	596 mm
Depth	565 mm

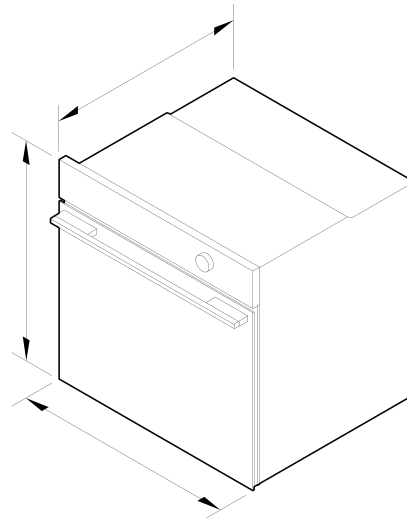

FEATURES & BENEFITS

Cook With Confidence

Using the large 5" touchscreen you can select a cooking method or hero ingredient and your oven will provide heat type and temperature recommendations for perfect results. For added versatility, you can also select your go-to cooking functions.

Generous Capacity

With a generous 85L total capacity, you can create several perfectly cooked dishes at once using multiple shelves. Non-tip, full-extension shelves help to ensure safe removal of hot dishes.

Exceptional Performance

Our unique cooking technologies were developed to help deliver perfect results. ActiveVent ensures optimized moisture levels, while AeroTech™ circulates heat evenly for a consistent temperature.

Safe And Sound

The CoolTouch door of this built-in oven is safe to touch from the outside. Sturdy, fully extendable shelves slide all the way out, reducing the need for you to reach inside.

Self-Cleaning

Pyrolytic self-clean breaks down food residue at a very high temperature, leaving a light ash that's easily removed with a damp cloth. The enamel coated side racks don't need to be removed when using this function.

Complementary Design

Designed to blend seamlessly into the kitchen, this Minimal style oven features subtle textural and tonal contrasts. Available in a black or grey finish to support a considered kitchen design. Pair with a Warming Drawer for the ultimate kitchen solution.

Multi-Function Flexibility

Each function has been tailored, tested and perfected to ensure that no matter what you're cooking, you've got the right heat to match. Purchase our Wireless Temperature Sensor accessory and precisely monitor cooking in real time (accessory sold separately).

SPECIFICATIONS

Accessories (included)

Full extension sliding shelves	1
Grill rack	1 set
Pyrolytic proof shelf runners	•

Roasting dish	1
Smokeless grill tray	1
Step down wire shelf	1
Wired temperature sensor	1

Capacity

Shelf positions	6
Total capacity	85 L
Usable capacity	72 L

Cleaning

Acid resistant graphite enamel	•
Pyrolytic self-clean	•
Pyrolytic-proof side ladders	•
Removable oven door	•
Removable oven door inner glass	•
Removable side ladders	•

Connected Features

Cyber security updates until	09 / 10 / 2030
------------------------------	----------------

Controls

Adjustable audio and display settings	•
Audio feedback	•
Automatic cooking/minute timer	•
Automatic pre-set temperatures	•
Celsius/Fahrenheit temperature	•

Delay start	•
Electronic oven control	•
Guided cooking by food type and recipes	•
Internal Light	•
Intuitive touchscreen display	•
Multi-language display	•
Sabbath mode with Mehadrin certification	•
Smart appliance	•
Soft close doors	•
Temperature sensor	•
Turned stainless steel dials with illuminated halos	•
Wireless temperature sensor compatible	•

UK English

Functions

Air fry	•
Bake	•
Classic bake	•
Dehydrate	•
Fan bake	•
Fan forced	•
Fan grill	•
Grill	•
Number of functions	16
Pastry Bake	•
Pizza bake	•
Pyrolytic self-clean	•
Rapid proof	•
Roast	•
Slow cook	•
Vent bake	•

Warm	•
------	---

Performance

ActiveVent™ system	•
AeroTech™ technology	•
Automatic rapid pre-heat	•
Grill power	3000 W
Temperature range	35°C - 280°C
Whisper Quiet Cooking	•

Power requirements

Amperage	15 A
Supply frequency	50 Hz
Supply voltage	220 - 240 V

Product dimensions

Depth	565 mm
Height	598 mm
Width	596 mm

Safety

Balanced oven door	•
Catalytic venting system	•
Control panel key lock	•
CoolTouch door	•
Non-tip shelves	•
Safety thermostat	•

SKU

82474

Our In-use Energy Carbon Emissions Estimate is designed to assist customers in making informed purchasing decisions when comparing different Fisher & Paykel products. For example, a heat pump dryer typically has a lower In-use Energy Carbon Emissions Estimate than a vented dryer.



A PEACE OF MIND SALE
24 Hours 7 Days a Week Customer Support

T 1300 650 590 [Wwww.fisherpaykel.com](http://www.fisherpaykel.com)

The product dimensions and specifications in this page apply to the specific product and model. Under our policy of continuous improvement, these dimensions and specifications may change at any time. You should therefore check with Fisher & Paykel's Customer Care Centre to ensure this page correctly describes the model currently available. © Fisher & Paykel Appliances Ltd 2020

Other product downloads available at fisherpaykel.com

- [↓](#) DWG
- [↓](#) DXF
- [↓](#) Archicad
- [↓](#) Installation Guide (English)
- [↓](#) Planning Guide - 60cm Minimal Ovens and Companions (English)
- [↓](#) Revit
- [↓](#) Rhino
- [↓](#) SketchUp
- [↓](#) User Guide (English)

Where applicable:

All appliances use energy, and energy usage typically generates carbon emissions. **Fisher & Paykel Appliances' In-use Energy Carbon Emissions Estimate** indicates carbon emissions from a product's in-use energy. This is calculated either annually or per cycle, using the product's market-specific energy label energy consumption data multiplied by the carbon emissions factor for energy in your country or region.