

# Dual Fuel Range, 36", 6 Burners, Self-cleaning, LPG

Series 9 | Professional

Stainless Steel | LPG



Get the best of gas and convection technology in this striking range with intuitive touchscreen and specialized cooking functions.

- Guided cooking using your touchscreen makes it simple to cook by food, function or recipe.
- Top burner heat of 19,000 BTU, for seriously fast boiling
- 4.8 cu ft total oven capacity
- Beautiful LED halo-illuminated dials provide information at a glance

## DIMENSIONS

<b>Height</b>	<b>35 3/4 - 36 3/4"</b>
<b>Width</b>	<b>35 7/8"</b>
<b>Depth</b>	<b>29 1/8"</b>

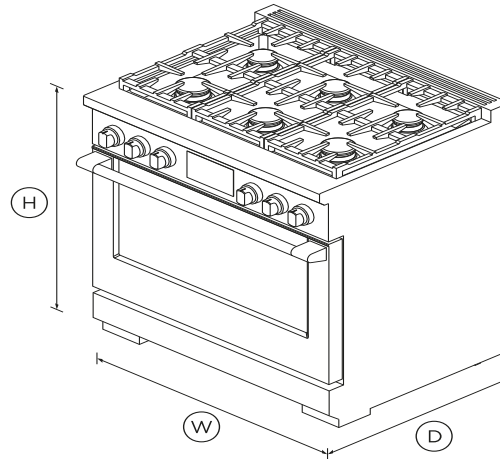

## FEATURES & BENEFITS

### Cook with confidence

Our touchscreen interface provides an intuitive guided cooking experience that helps deliver perfect results, whether you've been cooking all your life or just starting out. Cook with a favorite method, a hero ingredient, or a go-to cooking function or recipe. The screen tilts for improved ergonomics and optimal visibility while cooking.

### Generous capacity

Featuring a large 4.8 cu ft total capacity convection oven, with

enough room to fit a 32 lb turkey and full-size baking sheets.

### Cooking flexibility

No matter what you're cooking, you've got the right heat to get perfect results. Each of the 15 oven functions have been extensively researched and carefully designed to cater to a broad range of dishes and cooking styles. The handy food probe helps you monitor your progress.

### Cooktop power

Sealed dual flow burners deliver cooktop power up to 19,000 BTU for seriously fast boiling, and precise 140°F full surface, low temperature cooking with the gentlest of flames.

### Design quality

This range has craftsmanship in every detail, with real stainless steel, cast-iron grates, and beautifully weighted, halo illuminated dials. Each cavity features incandescent lights and full extension telescopic racks. From the robust legs to the powerful cooktop, this Range is built to last.

### Easy to clean

The oven features a self-cleaning function and self-clean proof side racks, which don't need to be removed when using this function.

## SPECIFICATIONS

### Accessories

Adjustable feet covers	•
Branded coin end cap	•
Square handle option	<b>AH-R36</b>

### Burner ratings

Maximum burner power	<b>19000 BTU</b>
Power back centre	<b>13000BTU</b>
Power back left	<b>13000BTU</b>

Power back right	<b>13000BTU</b>
Power front centre	<b>15000BTU</b>
Power front left	<b>19000BTU</b>
Power front right	<b>19000BTU</b>
Total cooktop power	<b>92000 BTU</b>

**Capacity**

Shelf positions	<b>5</b>
-----------------	----------

**Cleaning**

Easy clean porcelain basepan	•
Pyrolytic self-clean	•

**Controls**

Dial with illuminated halo	•
Electric circuit	<b>4 wire</b>
High resolution display	•
Metal illuminated dials	•
Multi-language interface	•
Precise cooking with food	•
Recipe and food based	•
Sabbath mode	•
Tilting touch screen interface	•
Wi-Fi connectivity	•

**Gas Requirements**

Fitting and pipe	<b>½ NPT, min. 5/8" flex line</b>
Supply Pressure (LPG)	<b>11" to 14" W.C</b>

**Oven features**

Concealed element	•
Electronic oven control	•
Food probe	•
Full extension telescopic	•
Internal light	•
Large broil pan	•
Self-clean proof side racks	•
True convection	•

**Oven functions**

Air fry	•
Bake	•
Classic bake	•
Clean	•
Convection Broil	•
Convection bake	•
Dehydrate	•
Maxi Broil	•
Number of functions	<b>15</b>
Pastry bake	•
Pizza bake	•
Rapid proof	•
Roast	•
Slow cook	•
True convection	•
Warm	•

**Oven performance**

Main oven - True convection	<b>2500W</b>
-----------------------------	--------------

**Power requirements**

Rated current	<b>30A</b>
Supply frequency	<b>60Hz</b>

**Product dimensions**

Depth	<b>29 1/8"</b>
Depth (excluding handles)	<b>29 1/8"</b>
Height	<b>35 3/4 - 36 3/4"</b>
Width	<b>35 7/8"</b>

**Rangetop features**

Sealed Dual Flow Burners™	<b>6</b>
Vent trim included	•

**Recommended Back Guards Ventilation**

Combustible situation	<b>BGRV3-3036H</b>
Non combustible situation	<b>BGRV2-3036 / BGRV2-1236</b>
Recommended hood	<b>HCB36-6_N (36" Professional)</b>

**Safety**

ADA compliant	•
Full extension telescopic	•

**Warranty**









Parts and labor	<b>Limited 2 years</b>
-----------------	------------------------

SKU	<b>81899</b>
-----	--------------

The product dimensions and specifications in this page apply to the specific product and model. Under our policy of continuous improvement, these dimensions and specifications may change at any time. You should therefore check with Fisher & Paykel's Customer Care Centre to ensure this page correctly describes the model currently available. ? Fisher & Paykel Appliances Ltd 2020

---

**Other product downloads available at fisherpaykel.com**

-  [User Guide](#)
-  [Service & Warranty](#)
-  [Installation Guide](#)
-  [Specification Guide Dual Fuel Range](#)
-  [Data Sheet Dual Fuel Range](#)
-  [Data Sheet Dual Fuel Range](#)
-  [Data Sheet Dual Fuel Range](#)
-  [Data Sheet Dual Fuel Range](#)
-  [Planning Guide Dual Fuel Range](#)



**A PEACE OF MIND SALE**

24 Hours 7 Days a Week Customer Support

T 1.888.936.7872 **W**www.fisherpaykel.com