

FISHER & PAYKEL

BUILT-UNDER DISHWASHER

CONTEMPORARY

DW60UC4X2, DW60UN4X2, DW60UN4B2, DW60UC2X2,
DW60UN2X2 & DW60UN2B2 models

INSTALLATION GUIDE

NZ AU

⚠ WARNING!



Electric Shock Hazard

Failure to follow this advice may result in electrical shock or death.

- This appliance must be earthed. This appliance has a cord with an equipment-earthing conductor and an earthing plug. The plug must be plugged into an appropriate outlet that is installed and earthed in accordance with all local regulations.
- **WARNING** – Improper connection of the equipment-earthing conductor can result in a risk of electric shock. Check with a qualified electrician or service technician if you are unsure if the appliance is properly earthed.
- Do not modify the power supply plug provided with the appliance. If a different outlet is required have it installed by a qualified electrician. Do not use an extension cord, adapter plug or multi-box.

⚠ WARNING!



Cut Hazard

Failure to use caution could result in injury.

- Take care – panel edges are sharp.

⚠ WARNING!



Weight Hazard

Failure to follow this advice may result in damage or personal injury.

- Do not attempt to lift this product unassisted.

SAFETY AND WARNINGS

WARNING!

To reduce the risk of fire, injury to persons or damage when using the appliance, follow the important safety instructions listed below. Read all the guidance before using the appliance.

Servicing

- Do not repair or replace any part of the appliance unless specifically recommended in this guide. All other servicing should be undertaken by a Fisher & Paykel trained and supported service technician or qualified person.

Installation

- Ensure all water connections are turned OFF. It is the responsibility of the plumber and electrician to ensure that each installation complies with all Codes and Regulations.
- The dishwasher MUST be installed to allow for future removal from the enclosure if service is required.
- The switched power outlet must be outside the dishwasher cavity, so that it is accessible after installation.
- This dishwasher is manufactured for indoor use only.
- Care should be taken when the appliance is installed or removed to reduce the likelihood of damage to the power supply cord and hoses.
- If the dishwasher is to be relocated from one installation to another it must be kept upright to avoid damage from water spillage.
- Make sure only new hoses are used for connection (supplied with the dishwasher). Old hoses should not be reused.
- Failure to install the dishwasher correctly could invalidate any warranty or liability claims.
- Ensure the dishwasher is placed between cabinetry. Failure to do so may result in an unstable product, which may cause damage or injury.
- Do not operate this appliance if it is damaged, malfunctioning, partially disassembled or has missing or broken parts, including a damaged power supply cord or plug.
- Do not store or use petrol, or other flammable vapours and liquids in the vicinity of the dishwasher.
- Connect to a properly rated, protected and sized power supply circuit to avoid electrical overload.
- Make sure that the power supply cord is located so that it will not be stepped on, tripped over or otherwise subject to damage or stress.
- Do not install or store the dishwasher where it will be exposed to temperatures below freezing or exposed to weather.
- Do not use an extension cord or a portable electrical outlet device (e.g. multi-socket outlet box) to connect the dishwasher to the power supply.
- This appliance must be earthed. In the event of a malfunction or breakdown, earthing will reduce the risk of electric shock by providing a path of least resistance for electric current.
- This appliance is equipped with a cord having an equipment-earthing conductor and an earthing plug. The plug must be plugged into an appropriate outlet that is installed and earthed in accordance with all local codes and ordinances.
- EARTHING INSTRUCTIONS - This appliance must be connected to a earthed metal, permanent wiring system, or an equipment-earthing conductor must be run with the circuit conductors and connected to the equipment-earthing terminal or lead on the appliance.
- Installation must comply with your local building and electricity regulations.

- Failure to install the custom panels correctly could invalidate any warranty or liability claims.
- Installation of this dishwasher requires basic mechanical and electrical skills.
- Be sure to leave these Instructions with the Customer.
- Installation must comply with your local building and electricity regulations.
- At the completion of the dishwasher installation, the Installer must perform the Final Checklist.
- Remove all packaging materials supplied with the dishwasher.
- If the product is installed in a motor vehicle, boat or similar mobile facility, you must bring the vehicle, boat or mobile facility containing the product to the service shop at your expense or pay the service technician's travel to the location of the product.

SAVE THESE INSTRUCTIONS

The models shown in this installation guide may not be available in all markets and are subject to change at any time. For current details about model and specification availability in your country, please go to our website www.fisherpaykel.com or contact your local Fisher & Paykel dealer.

COMPONENTS REQUIRED

PARTS

- Keep all packing materials until the unit has been inspected.
- Inspect the product to ensure there is no shipping damage. If any damage is detected contact the dealer or retailer you bought the product from to report the damage.
- Fisher & Paykel is not responsible for shipping damage.

Supplied



Spacers (4)



Moisture protection tape (1)

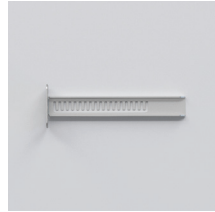

Toe kick brackets (2)*

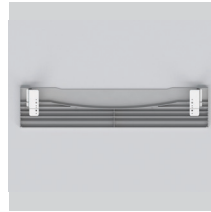

Pre-finished toe kick assembly (1)



Drain hose support (1)

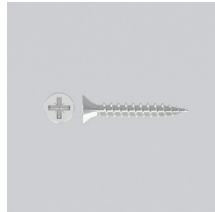

4 x 25mm screws (4)

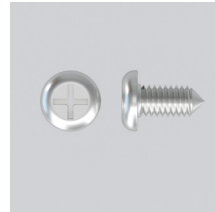

4 x 13mm screws (5)

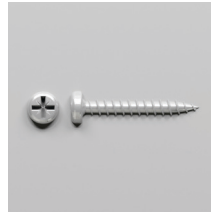

4.2 x 50mm screws (2)



Washer (2)



Sound seal (1)

TOOLS

Not supplied



Powered driver



Cross-head screw driver



Flat-head screw driver



Box cutter

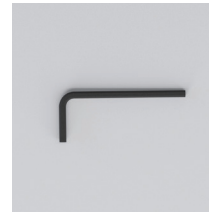

5mm Allen Key

Supplied



4mm / 6mm Allen Key

PRODUCT DIMENSIONS

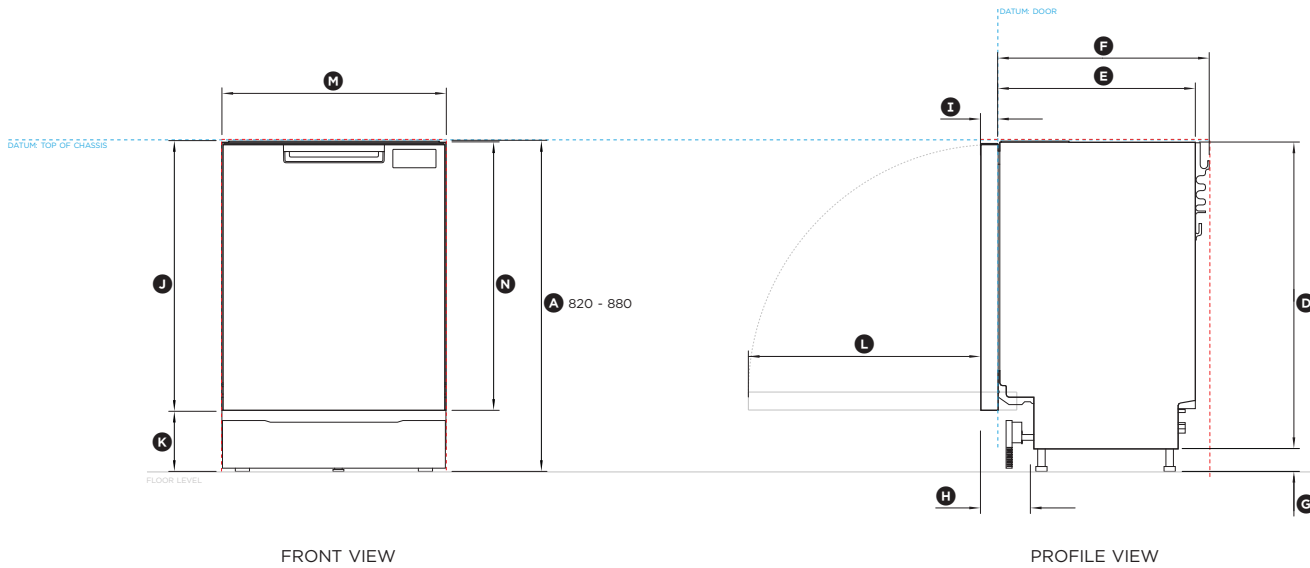
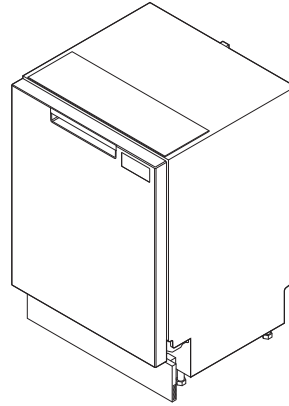
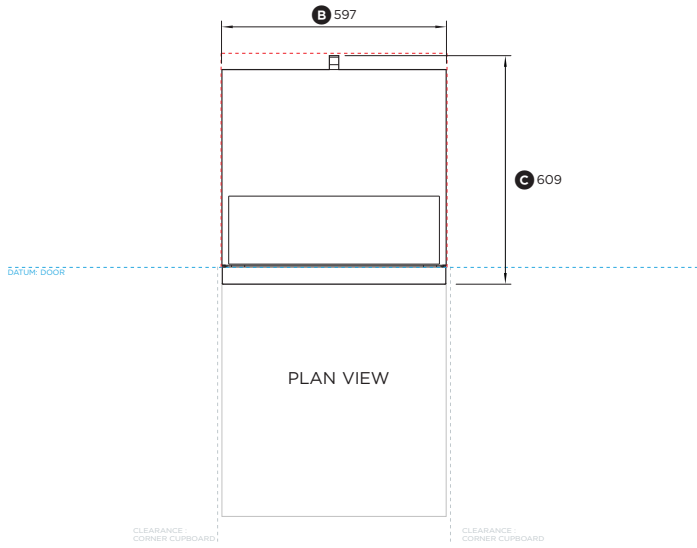

Models:

DW60UC4X2, DW60UC2X2

Product Dimensions	mm
Ⓐ Overall height of product*	820 - 880
Ⓑ Overall width of product	597
Ⓒ Overall depth of product	570
Ⓓ Height of chassis	820
Ⓔ Depth of chassis	521
Ⓕ Height of feet*	0 - 60
Ⓖ Depth of toe kick recess	142
Ⓗ Door panel depth	46
Ⓘ Height from top of chassis to bottom of door panel	718
Ⓚ Height from the bottom of door to floor*	103
Ⓛ Depth of door opening	620
Ⓛ Door panel width	590
Ⓜ Door panel height	717

*depending on adjustment of levelling feet

Minimum Clearances	mm
Minimum inside height of cavity*	820
Minimum inside width of cavity	600
Minimum overall depth of cavity	580
Minimum clearance to corner cupboard	13
Minimum clearance to adjacent cupboard door	2

*depending on adjustment of levelling feet

IMPORTANT NOTE: Throughout this guide, dimensions may vary by $\pm 2\text{mm}$ (1/16"). Please read the installation guide for detailed information on installing the product. For full installation instructions & specifications visit fisherpaykel.com



INDICATES PRODUCT DATUM -----
INDICATES CABINETRY CLEARANCES -----

PRODUCT DIMENSIONS

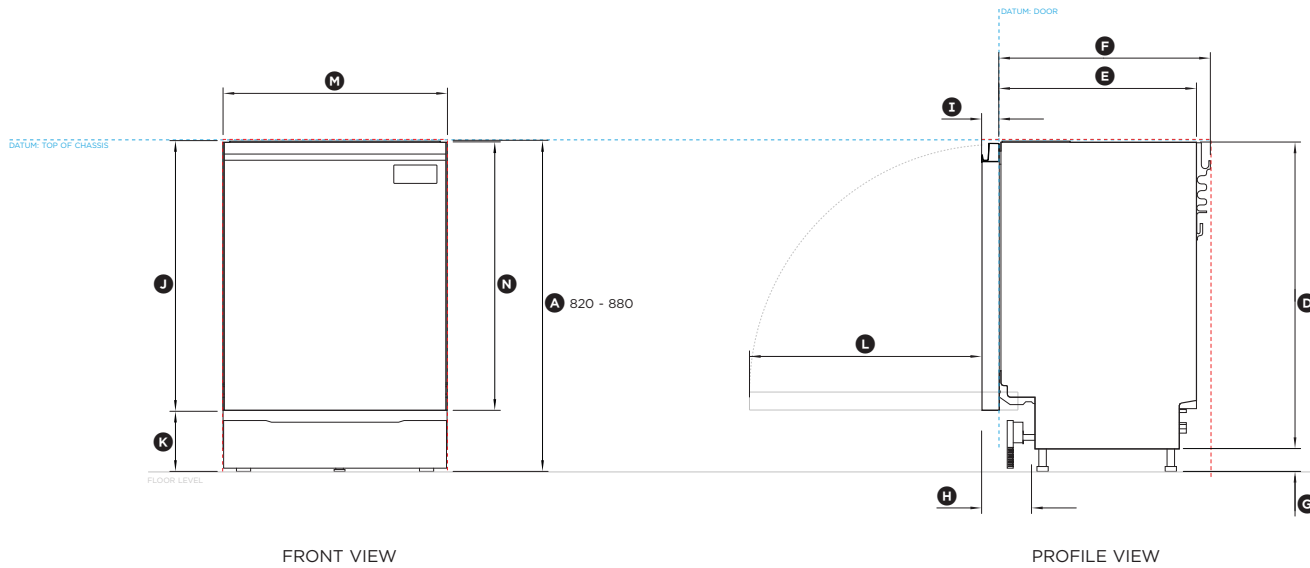
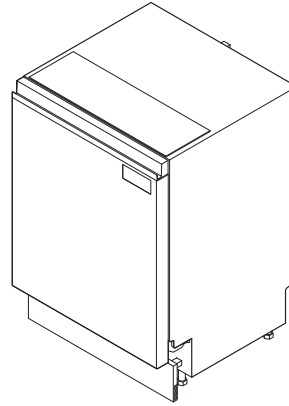
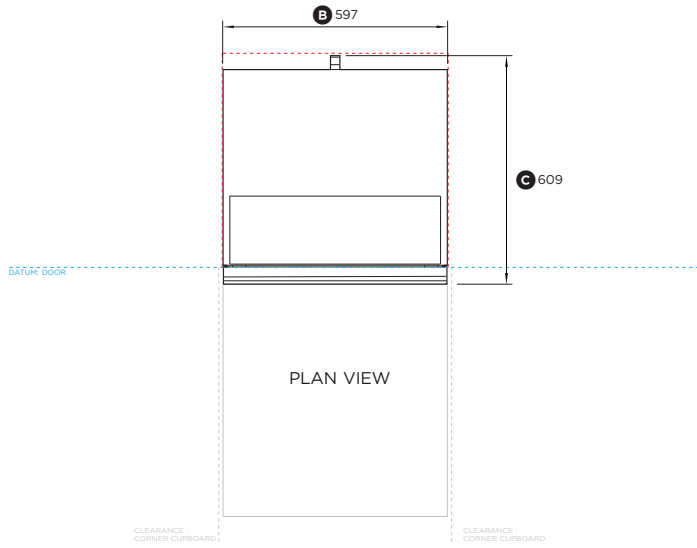

Models:

DW60UN4X2, DW60UN4B2, DW60UN2X2, DW60UN2B2

Product Dimensions	mm
Ⓐ Overall height of product*	820 - 880
Ⓑ Overall width of product	597
Ⓒ Overall depth of product (incl. panel and hose support)	570
Ⓓ Height of chassis	820
Ⓔ Depth of chassis	521
Ⓣ Height of feet*	0 - 60
Ⓤ Depth of toe kick recess	142
ⓕ Door panel depth	46
ⓖ Height from top of chassis to bottom of door panel	720
ⓗ Height from top of door to floor*	103
ⓓ Depth of door opening	620
ⓙ Door panel width	595
ⓚ Door panel height	717

*depending on adjustment of levelling feet

Minimum Clearances	mm
Minimum inside height of cavity*	820
Minimum inside width of cavity	600
Minimum overall depth of cavity	580
Minimum clearance to corner cupboard	13
Minimum clearance to adjacent cupboard door	2

*depending on adjustment of levelling feet

IMPORTANT NOTE: Throughout this guide, dimensions may vary by ± 2 mm (1/16"). Please read the installation guide for detailed information on installing the product. For full installation instructions & specifications visit fisherpaykel.com



INDICATES PRODUCT DATUM -----
INDICATES CABINETRY CLEARANCES -----

CABINERY

DIMENSIONS

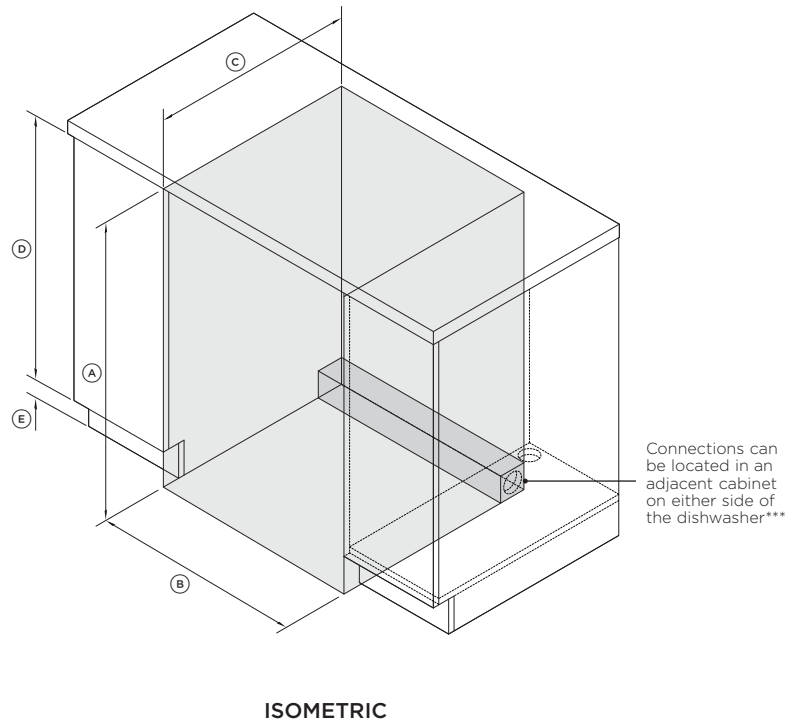

CABINERY DIMENSIONS	MM
Ⓐ Minimum inside height*	820
Ⓑ Minimum inside width	600
Ⓒ Minimum overall depth**	580
Ⓓ Recommended height of adjacent cabinetry	713-794
Ⓔ Height of toe kick area	65-200

*depending on adjustment of levelling feet

**including 19mm door panels on adjacent cabinetry

***For more information on service requirements, refer to 'Plumbing & electrical considerations' and 'Cabinetry preparation'.

CLEARANCES

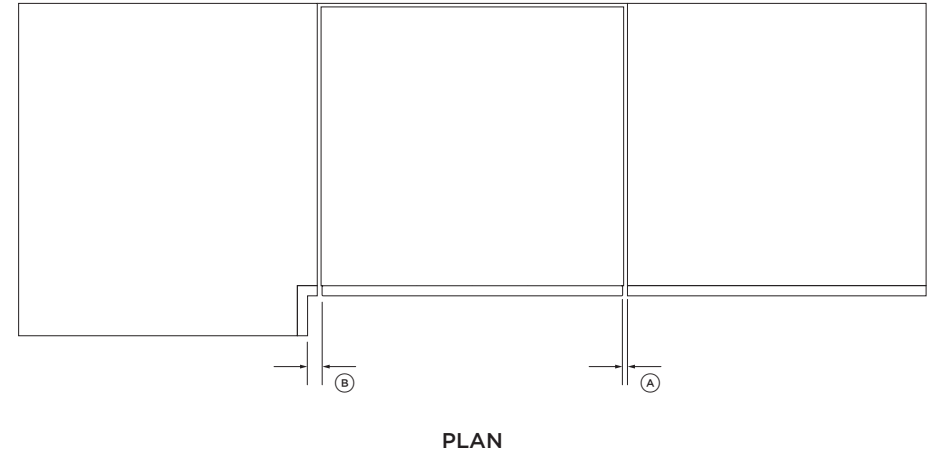

CABINERY CLEARANCES	MM
Ⓐ Minimum clearance to adjacent cupboard door	2
Ⓑ Minimum clearance to corner cupboard	13

PLUMBING & ELECTRICAL CONSIDERATIONS

Hose and cord lengths

- Your services can be installed to **either** the left-hand or right-hand side of the product in an adjacent cabinet. Refer to 'Cabinetry preparation' for service access requirements.
- The drain hose should not extend more than 4m. A longer drain hose will cause reduced performance.

Water connection

- The dishwasher should not be connected to a water system where there is no temperature control, unless the system is fitted with a suitable tempering valve.
- The dishwasher must not be connected to an undersink high-pressure push-through hot water system, as damage to the system will result.
- Maximum water temperature: 60°C
- 3/4 BSP connector water inlet hose
- Ensure water connection complies with local plumbing regulations.

Water pressure

- 0.03-1MPa

Electrical requirements

- 230V, 50Hz, 10A

Anti-flood protection

- This dishwasher has anti-flood protection, which will stop the water flowing in the event of a leak within the machine.

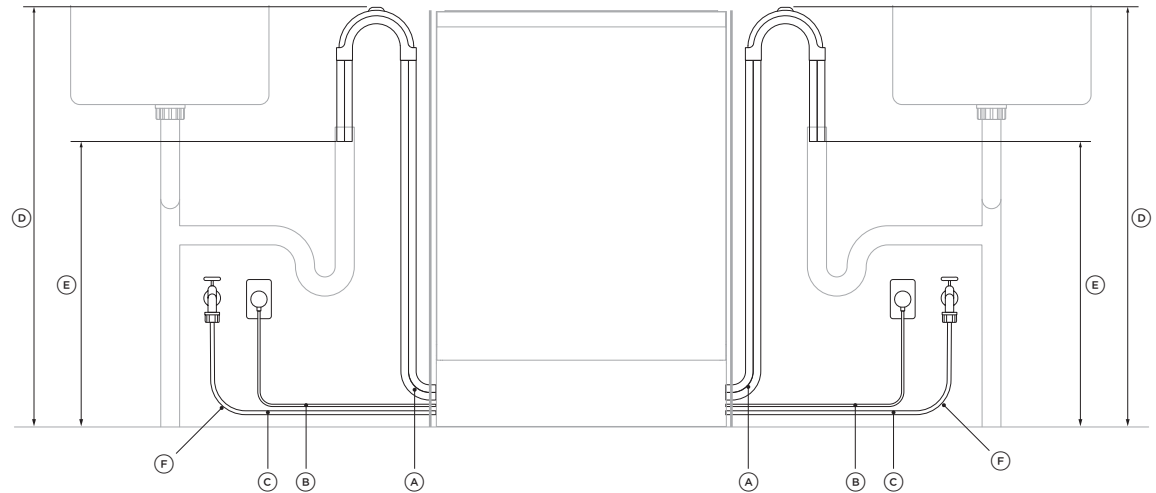

SERVICE DIMENSION	LEFT SIDE	RIGHT SIDE
	MM	MM
(A) Length of drain hose	1980	1650
(B) Length of power cord*	950	1450
(C) Length of inlet hose	1450	1300
(D) Distance from floor to top of hose support	750-883	750-883
(E) Minimum distance from floor to end of drain hoses**	500	500
(F) Minimum inlet hose radius	200	200

*excluding plug

**standpipe install illustrated. Distance is the same for all plumbing installs.

SERVICE ACCESS

- We recommend locating the service holes on **either** side of the Dishwasher as shown.
- If the holes are created through wood, ensure the edges are smooth and rounded
- If the holes are created through metal, ensure an edge protector is fitted.

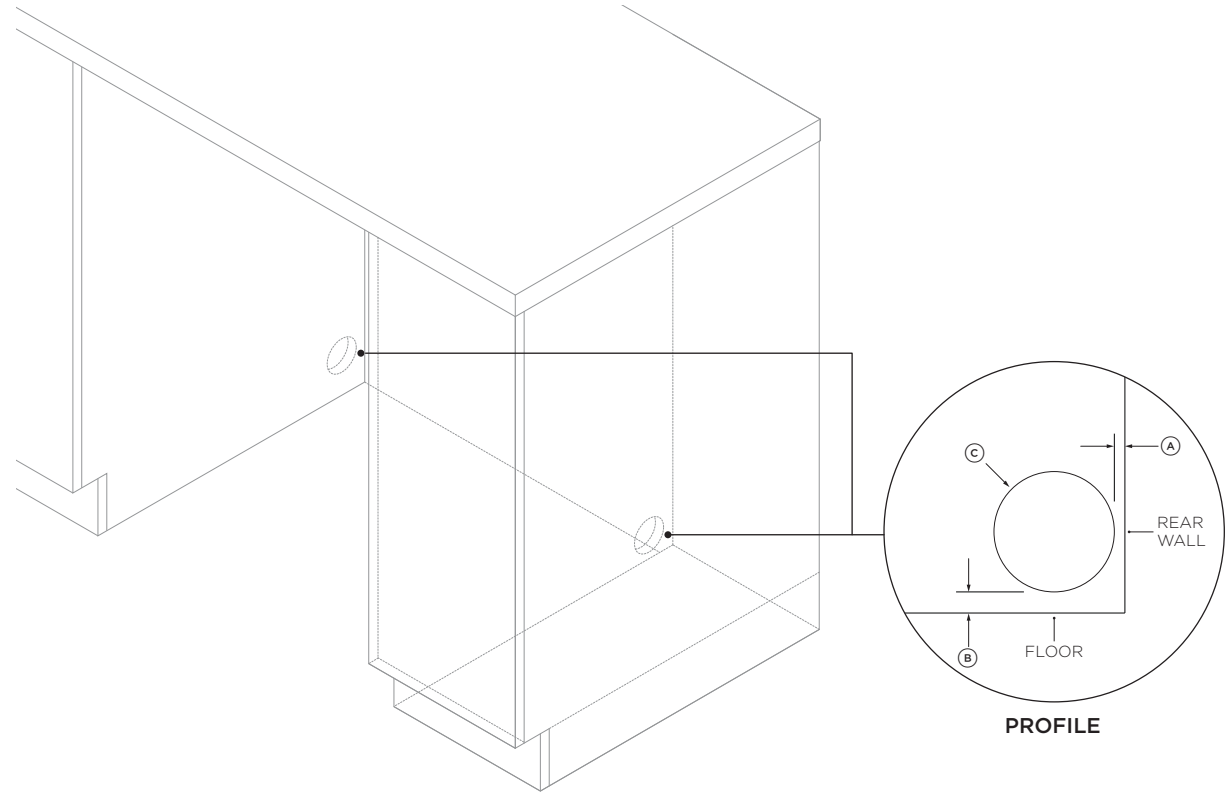

SERVICE HOLE DIMENSIONS

MM

Ⓐ	Maximum distance between rear of cavity and service hole*	15
Ⓑ	Maximum distance between floor and service hole**	0-50
Ⓒ	Minimum diameter of service hole	70

*based on a cabinetry depth of 580mm

**depending on adjustment of levelling feet

UNPACK PRODUCT

①



Cut straps, lift carton off product and remove the top cap.
Dispose of packaging responsibly.

②



Remove the install kit, any internal packaging, all rubber bands and all tape.

CABINETRY PREPARATION

①



Ensure all minimum cabinetry and service specifications have been met and that all services will be accessible after installation.

②



Ensure cabinetry floor is free from bumps and obstructions that could prevent the Dishwasher from sliding into the cavity.

③



Align the supplied moisture protection tape to the cabinetry as shown.
Ensure this area is free of debris before carefully applying the tape to the surface.

PUSH INTO CAVITY

①



Using a flat bladed screwdriver, turn to raise the leveling feet. Level the rear, outside legs first followed by the front legs. Do not adjust the rear middle leg yet.

②



Remove both screw covers before partially pushing the product into the cavity, pulling the hoses through as you push to avoid crushing or twisting them. Take care not to bend the legs.

Push the product from the outside edges to avoid door damage.

③

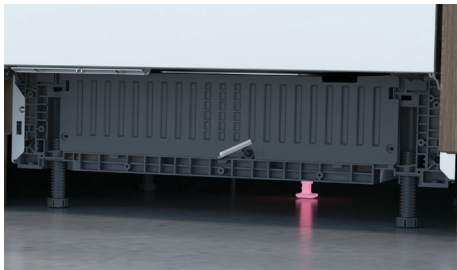

Check the product sits level within the cavity.

If required, the rear middle leg can be adjusted from the front of the product using a 5mm Allen key.

④



Select desired spacer width and cut to size. Remove adhesive and fit two spacers to each side of the product.

Push the product into the cavity from the outside edges.

SECURE TO CAVITY

①



Loosely fit 2 x side fixing screws.

②

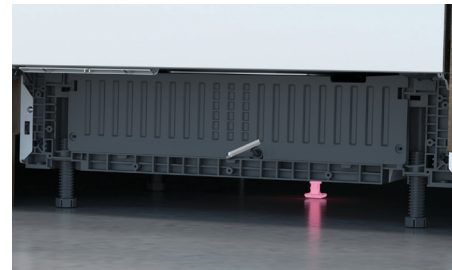

If needed, adjust the Dishwasher within the cavity before tightly securing in place. Replace the screw covers.

③



Secure to benchtop using 2 x screws if possible.

INSTALL SOUND SEAL

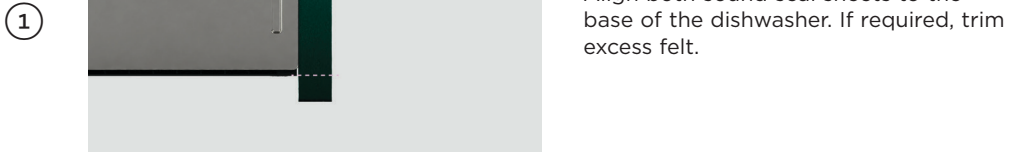

Align both sound seal sheets to the base of the dishwasher. If required, trim excess felt.



Ensure door swing is unobstructed before securing the seals using the provided washers and 4.2 x 50mm screws.

INSTALL TOE KICK

PRE-FINISHED TOE KICK

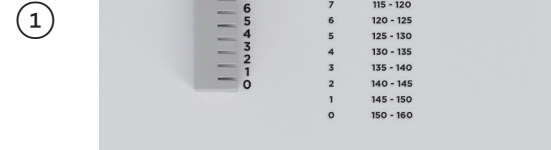

Measure the distance between the floor and the base of the door. Refer to the table and mark out the cut location. Score at the marked height, snap off excess material and smooth edges.

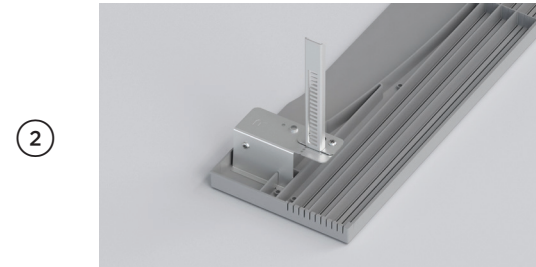

Ensure brackets are oriented correctly before fitting to the panel using 2 x screws per bracket.

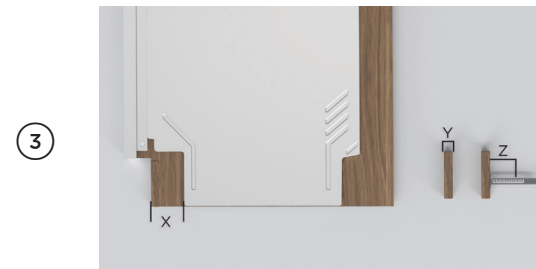

Measure the toe kick depth:

$$\text{toe kick recess} - \text{panel thickness} = \text{toe kick depth}$$

- =

Use (Z) to determine which tooth to bend back on each toe kick bracket.

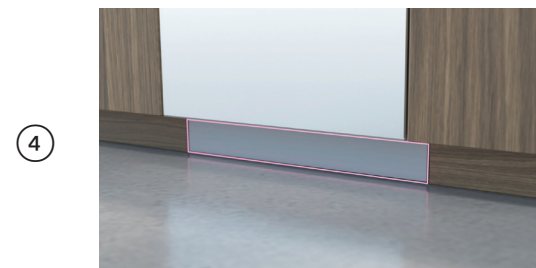

Align the brackets to the slots on the product and slide into place.

INSTALL TOE KICK

CONTINUOUS TOE KICK PANEL

1

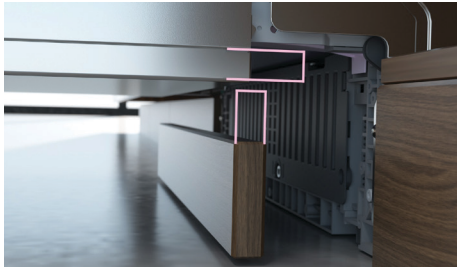

Align toe kick to product and ensure all door swing clearances have been met.

2

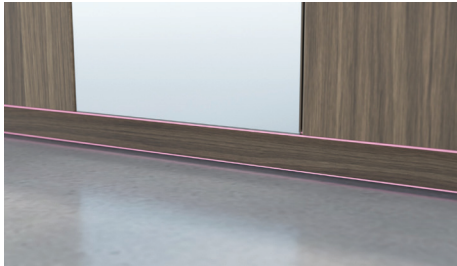

Fit panel to surrounding cabinetry

CUSTOM TOE KICK PANEL

1



Mark the pilot hole locations for each bracket. Measure the centre of the panel and mark 237mm to each side. To determine the height of the brackets, measure the height of the lowest bracket hole against the toe kick panel.

2



Ensure brackets are oriented correctly before fitting to the panel using 2 x screws per bracket.

3



Measure the toe kick depth:

$$\begin{matrix} \text{toe kick recess} & & \text{panel thickness} & & \text{toe kick depth} \\ \boxed{\text{X}} & - & \boxed{\text{Y}} & = & \boxed{\text{Z}} \end{matrix}$$

Use Z to determine which tooth to bend back on each toe kick bracket.

4

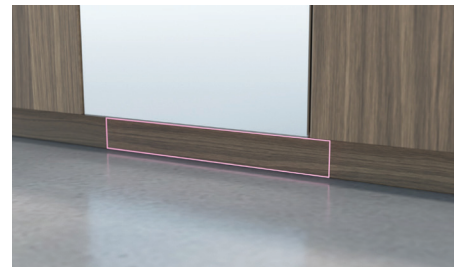

Align the brackets to the slots on the product and slide into place.

Ø38MM STANDPIPE INSTALLATION

1



Install the drain hose support to the back wall, as close to the underside of the countertop as possible. Refer to 'Plumbing & electrical considerations' for minimum install heights.

2



Pull the hose through the support guide and rest in standpipe. Ensure the drain hose does not extend into water retained in the trap; an air gap is required to prevent waste water from siphoning back into the tub.

3



Ensure the rubber washer is fitted when connecting the inlet hose to the tap. Hand-tighten into place. Using a spanner or pliers, turn a further 180° to secure. Avoiding over-tightening. **Do not turn water supply on. The Dishwasher must be powered on for the flood protection feature to be enabled.**

4



Plug product in.

SINK TRAP/WASTE TEE INSTALLATION

1



Install the drain hose support to the back wall, as close to the underside of the countertop as possible. Refer to 'Plumbing & electrical considerations' for minimum install heights.

2

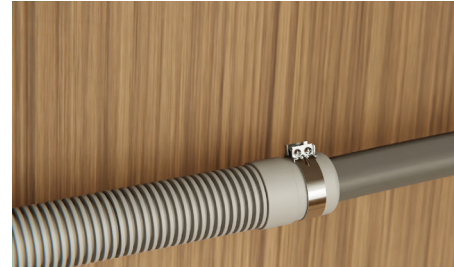

Pull the hose through the drain hose support before threading the hose clamp onto the hose and fitting to the sink trap. Secure to trap using the clamp. Ensure hose is routed straight to the trap. Unplug or drill out the waste tee before securing joiner to sink trap or waste tee.

3



Ensure the rubber washer is fitted when connecting the inlet hose to the tap. Hand-tighten into place. Using a spanner or pliers, turn a further 180° to secure. Avoiding over-tightening. **Do not turn water supply on. The Dishwasher must be powered on for the flood protection feature to be enabled.**

4



Plug product in.

INSTALLER CHECKLIST

TO BE COMPLETED BY THE INSTALLER

Installation

- Check all parts are installed correctly and are secure.
- Ensure all packaging, tape and rubberbands have been removed.
- Ensure all clearance gaps have been maintained.
- Ensure Dishwasher is securely fastened to the cabinetry and door opens and closes freely with no resistance.
- Ensure panel is fitted correctly to the Dishwasher
- Check the spray arm is in place, mounted correctly and rotates freely.

Plumbing

- Ensure any knock-outs or plugs in drain connection have been drilled out and drain connection has been made.
- The drain hose joiner must not support the weight of excess hose material. Keep drain hose as fully extended as possible to prevent sagging. Any excess length of drain hose should be kept on the dishwasher side of the drain hose support.
- Ensure inlet hose has supplied rubber washer fitted, and that it is tightened.
- If connecting the drain hose to the sink trap, ensure the highloop is a minimum 150mm higher than the drain hose joiner.
- Water softener models: adjust the water softener setting from the default setting to suit the water hardness of the area. Refer to your user guide.
- Ensure water supply is turned off until power is connected and turned on. The Dishwasher must be powered on for the flood protection feature to be enabled.

Electrical

- Ensure all electrical tests have been conducted in accordance with local regulations.
- If site is left without power after installation is complete, ensure water supply is turned off to prevent flooding.**

TEST OPERATION

①



Turn power and water supply on and open the dishwasher.

②



Select **RINSE**.

③



After the **RINSE** cycle has finished, ensure the dishwasher has run and drained correctly.

FISHERPAYKEL.COM

© Fisher & Paykel Appliances 2023. All rights reserved.

The models shown in this guide may not be available in all markets
and are subject to change at any time.

The product specifications in this guide apply to the specific products and
models described at the date of issue. Under our policy of continuous product
improvement, these specifications may change at any time.

For current details about model and specification availability in your country,
please go to our website or contact your local Fisher & Paykel dealer.

431060B 12.23