

494L Series 5 Refrigerator Freezer

Contemporary

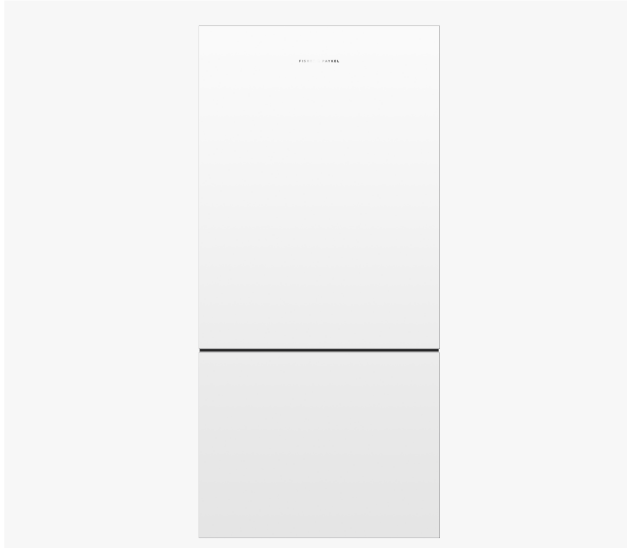

With ample storage and a stylish stainless steel finish, for a timeless look.

- ActiveSmart™ technology helps keep food fresher for longer by constantly maintaining the ideal temperature.
- Spacious bottom freezer with easy-slide internal drawers to separate storage

DIMENSIONS

Height	1720 mm
Width	790 mm

Depth

695 mm

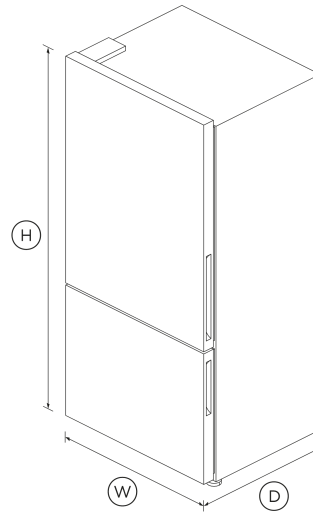

FEATURES & BENEFITS

Activesmart™ Foodcare

ActiveSmart™ Foodcare learns how you live. It's technology which understands how you use your refrigerator and adjusts temperature, airflow and humidity inside to help keep food fresher for longer.

Humidity Control

Your fruit and veges need different environments. The humidity control slides in each storage bin create a microclimate that helps keep food fresher for longer.

SIMPLE STORAGE

This fridge is designed to make it simple for you to store, access and remove food. Storage bins give you full access inside when they're pulled open and can be easily removed to clean. Our flexible shelving also gives you more storage options.

Clever Energy

Your refrigerator adapts to daily use by cooling and defrosting only when needed. This means it uses the energy it needs without compromising on food care.

Easy cleaning

Spill-safe secure glass shelves easily capture any drips or leaks and prevent them from falling on items below.

Design quality

Our refrigerators are designed and built using quality materials. We use pre-painted steel, and solid glass for shelving.

SPECIFICATIONS

Capacity

Total gross capacity	519 L
Volume	494 L
Volume freezer	146 L
Volume refrigerator	348 L

Connected Features

Cyber security updates until	04 / 03 / 2028
------------------------------	----------------

Consumption

Energy rating	4 star (IEC - 2015), 3 star (AS/NZS - 2009)
Energy usage	376kWh/year (IEC 62552-2015), 467kWh/year (AS/NZS 4474.2:2009)
In-use energy carbon emissions estimate	229.4kgCO2e/year (IEC 62552-2015), 285.0kgCO2e/year (AS/NZS 4474.2:2009)

Small plastic bins •

SKU 26421

Features

Adjustable door shelves	4
Adjustable glass shelves	4
Covered door shelves	2
Door alarm	•
Front levelling feet	•
Fruit and vegetable bins	2
LED lighting	•
Rear rollers	•
Single bottle holders	2
Smart appliance	•
SmartTouch control panel	•

Performance

- ActiveSmart™ Foodcare •
- Adaptive defrost •
- Frost free freezer •
- Humidity control system •
- Inverter controlled compressor •

The product dimensions and specifications in this page apply to the specific product and model. Under our policy of continuous improvement, these dimensions and specifications may change at any time. You should therefore check with Fisher & Paykel's Customer Care Centre to ensure this page correctly describes the model currently available. © Fisher & Paykel Appliances Ltd 2020

Other product downloads available at fisherpaykel.com

- [↓](#) DWG
- [↓](#) DXF
- [↓](#) Data Sheet (English)
- [↓](#) Energy Label
- [↓](#) Installation Guide (English)
- [↓](#) Revit
- [↓](#) Rhino
- [↓](#) SketchUp
- [↓](#) User Guide (English)
- [↓](#) Installation & User Guide (English)

Power requirements

Rated current	10 A
Supply frequency	50 Hz
Supply voltage	230 V

Product dimensions

Depth	695 mm
Height	1720 mm
Height to top of cabinet	1720 mm
Minimum air clearance - at rear	30 mm
Minimum air clearance - each side	20 mm
Minimum air clearance - on top	50 mm
Width	790 mm

Where applicable:

All appliances use energy, and energy usage typically generates carbon emissions. **Fisher & Paykel Appliances' In-use Energy Carbon Emissions Estimate** indicates carbon emissions from a product's in-use energy. This is calculated either annually or per cycle, using the product's market-specific energy label energy consumption data multiplied by the carbon emissions factor for energy in your country or region.

Freezer Features

Bottle chill	•
Fast freeze	•
Ice trays	2
Large plastic bins	•
Slide Out Pastry Tray	•

Variable Temp Compartment

Bottle chill mode •

Our In-use Energy Carbon Emissions Estimate is designed to assist customers in making informed purchasing decisions when comparing different Fisher & Paykel products. For example, a heat pump dryer typically has a lower In-use Energy Carbon Emissions Estimate than a vented dryer.



A PEACE OF MIND SALE
24 Hours 7 Days a Week Customer Support
T 1300 650 590 W www.fisherpaykel.com