

Freestanding Dishwasher, Sanitise

Series 5 | Contemporary

Stainless Steel



Designed to match the Contemporary family of appliances, this dishwasher offers multiple wash options and flexible loading.

- Seven wash programs from Heavy to Light, including Auto, 60min and Eco
- Dry+, Sanitise, Half Load and Intensive modifiers provide extra wash options
- Flexible freestanding installation anywhere in your kitchen
- Auto program senses the optimal wash cycle for your dishes

DIMENSIONS

Height	848 - 893mm
Width	597mm
Depth	600mm

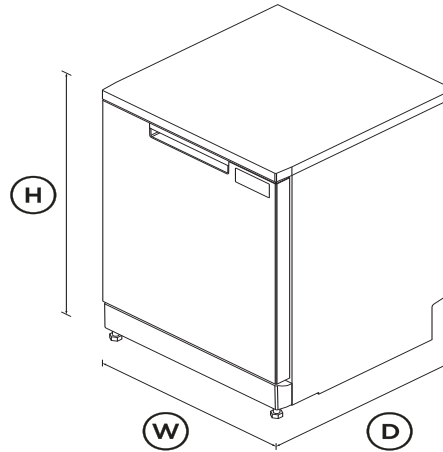

FEATURES & BENEFITS

Considered design

Designed to match our Contemporary style family of products, this freestanding dishwasher has a sleek stainless steel finish with a front-of-door control panel for intuitive usability.

A reliable clean

This dishwasher offers seven wash programs including Auto, which automatically senses the optimal wash settings for your dishes. The three-stage filtration system delivers a superior clean, while the rinse aid indicator reminds you to top up for beautifully clean dishes.

Customise your wash

The Half Load modifier is perfect for washing a partial load, for faster turnaround of dishes. Sanitise provides extra protection, killing 99.9% of bacteria* in the final rinse, while the Dry+ modifier is great for plastic dishes. *Certified to NSF/ANSI Standard 184

Efficient performance

With a 5 star water rating, this dishwasher delivers a powerful wash. Use the Eco wash program for optimal water and energy consumption, or choose when the cycle begins with Delay Start.

Flexible loading

Designed to fit 15 place settings with ease, adjustable racks help you to load and care for various items – including a height-adjustable upper basket, and foldable cup holders and tines.

SPECIFICATIONS

Capacity and loading

Accommodates round plates	320mm
Accommodates round plates	250mm
Adjustable height, foldable	•
Fold down tines	•
Height adjustable top basket	•
Place settings	15

Consumption

Energy rating	3.5 star
Energy usage	295kWh/year
In-use energy carbon	39.9kgCO2e/year
Water consumption (per wash)	12.2L
Water efficiency	5 star (WELS)

Controls

Energy saving delay start	•
Intuitive capacitive touch	•
Keylock	•
Rinse aid indicator light	•
Time remaining LED display	•

Features

Flood protection	•
Half load option	•
Internal tub material	Stainless Steel
Motor type	Asynchronous
ThermoDry system	•
Three-stage filtration system	•

Performance

Noise emissions	48dBA
-----------------	--------------

Power requirements

Amperage	10A
Supply frequency	50Hz
Supply voltage	220 - 240V

Product dimensions

Depth	600mm
Height	848 - 893mm
Width	597mm

Warranty

Parts and labour	2 years
------------------	----------------

Wash Program Modifiers

Dry +	•
Half-load	•
Sanitise	•
Wash modifiers	3

Wash Programs

60 min	•
Auto	•
Eco	•
Heavy	•
Light	•
Medium	•
Rinse	•
Wash programs	7

Water connection

Water pressure	30kPa - 1000 kPa
Water supply	3/4" BSP (20mm) Connector

SKU	82426
-----	--------------

The product dimensions and specifications in this page apply to the specific product and model. Under our policy of continuous improvement, these dimensions and specifications may change at any time. You should therefore check with Fisher & Paykel's Customer Care Centre to ensure this page correctly describes the model currently available. ? Fisher & Paykel Appliances Ltd 2020

Other product downloads available at fisherpaykel.com

- [↓](#) Service & Warranty
- [↓](#) User Guide Dishwasher
- [↓](#) Energy & Water Label
- [↓](#) Installation Guide Dishwasher
- [↓](#) Preliminary Specification Guide Dishwasher
- [↓](#) Data Sheet Dishwasher



A PEACE OF MIND SALE

24 Hours 7 Days a Week Customer Support

T 0800 372 273 W www.fisherpaykel.com