

AIR-COOLED MODULAR CHILLER AIR-COOLED (R410A)



Haier

CONTENTS

1. Nomenclature	1
2. Feature	1
3. Specification	6
4. Dimension.....	8
5. Installation	9
6. Controller Operation Instruction.....	24
7. Wiring Diagram.....	27
8. Commissioning, Operation and Maintenance.....	29
9. PCB Photo and Address Code Setting	33
10. Fault Code	34
11. Trouble Shooting.....	36
12. Unit Operating Range and Service Condition.....	38
13. Technical Parameters	39

1. Nomenclature

Code Explanation for chiller

1	2		3	4	5	6	7		8		9		10				
Chiller system	Compressor type		Capacity (for Centrifugal chiller: Rt; other: kW)				Product type		Unit character		Suitable voltage		Design number				
C	Centrifugal chiller		C	1	0	6	9	Heat pump	R22	A	Air cooled	A	100-115V, 60Hz	1	Fixed frequency	A-G	
	Screw chiller	Air cooled	I	0	2	3	7		R407C	B	Water cooled	W	220-240V, 50Hz	2	Inverter	H-Q	
		Water cooled		0	0	1	2		R132	C	Earth source	E	115-220V, 50/60Hz	3	DC inverter	R-Z	
		Earth source						R134A	D		220-220V, 60Hz		4				
	Air-cooled module chiller		A					R410A	E			110V, 50-60Hz	5				
	Light chiller	Split-packaged	H					Cooling only	R22	M		E	220V, 50-60Hz	6			
		Single-packaged	R						R407C	N			127V, 60Hz	7			
	Water-cooled cabinet chiller		W						R132	O				240V, 50Hz	8		
	Hydronic system	Cassette	B						R134A	P				110-220V, 50/60Hz	9		
		Duct	D						R410A	Q				330V, 50Hz	A		
		Cabinet	P												400V, 50Hz	B	
		Wall mounted	S										3300V, 50Hz	C			
													6600V, 50Hz	D			
												380-400V, 50Hz	N				
												415V, 50Hz	M				

2. Feature

2.1 Product feature

New appearance

New Y-shape design, more fashion

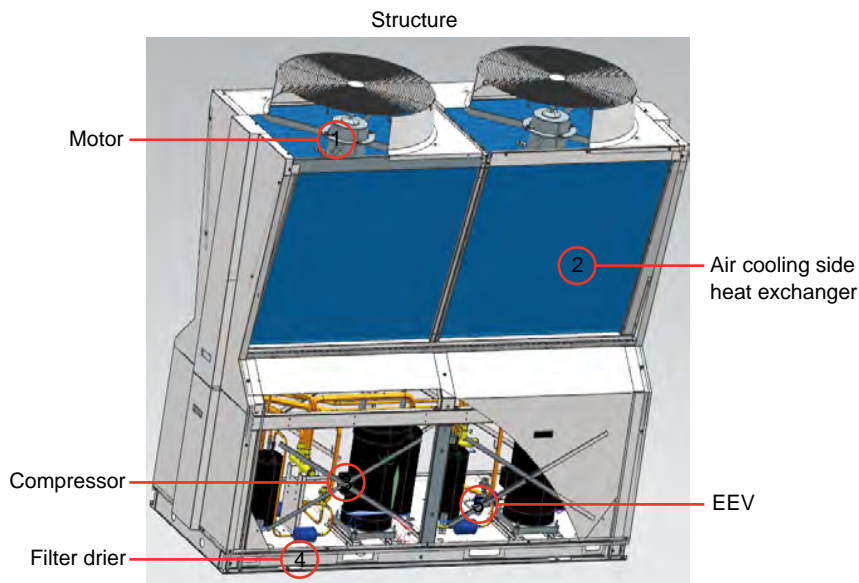

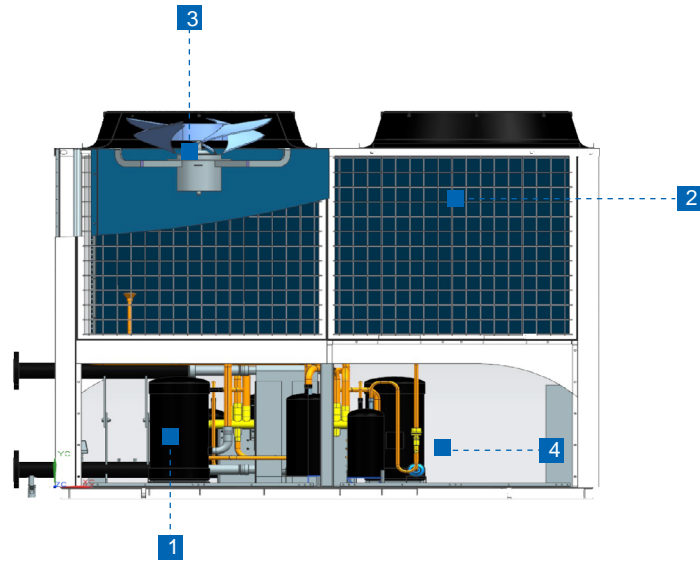

1 Compressor

Best scroll compressor, low sound power level, high EER, various protection: discharge temp. protection, high/low pressure protection, over current protection and reverse protection, etc..



2 Air cooling side heat exchanger

By using calculation model and acquiring heat exchanging ratio to optimize the windward air speed and condensation temp.



3 Motor

Low sound power level axial fan, together with the high efficient motor, making higher efficiency and lower sound power level.



4 EEV

High efficient EEV (thermostatic expansion valve) to adjust the overheating degree of system to control refrigerant volume. High efficient evaporator to make part load and full load COP the highest.



Compact design, reduce footprint

New Y-shape design, small floor area, only 1.56m², 28% footprint can be reduced.



2.18m²

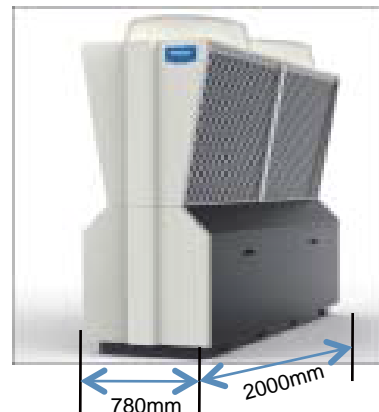
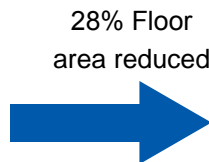

1.56m²

High efficiency system

The new series adopt more high efficient parts and unique design ensure the chiller high efficiency EER up to 3.4.COP above 3.4 (R410A Series).

EEV control, the 1400 steps high-performance electronic expansion valve



High efficiency compressor, adopts the famous brand, low noise level, high EER



High efficiency heat exchanger, Condenser adopts the Copper tube & hydrophilic aluminum fin coil type structure, increase the heat exchange efficiency 20%.

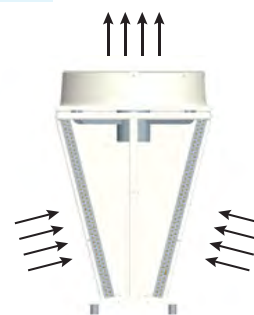

High Reliability

Backup operation function

The system has three modules, the actual operation of just two module, if one module malfunction another module will start automatically according to the water temperature.

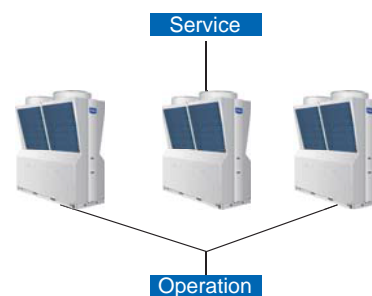

Three phase fan motor

Three phase fan motor, compared with one phase fan motor low starting current, high speed and more stable.



Filter drier

Filter drier, absorb moisture in the system, avoid the emergence of the "ice block"



Shell & Tube heat exchanger

The new modular chiller adopt Shell&Tube heat exchanger avoid dirty plugging, higher efficiency and reliability.



Pressure sensor control

Through the pressure sensor real-time monitoring, realize the system quickly, accurately control, ensure the unit efficient and stable operation.



Safety and protection

Phase reverse protection, high and low pressure protection, freeze protection, overheat protection, overload protection, etc.

Easy to Installation

Modular design

Max 1040 kW with 16 modules, flexible combination, more convenient for design and transportation.

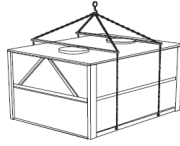

Standard of target type flow switch

Standard of target flow switch, prevent non-work personnel wrong operation.



Standard of water filter

Standard of water filter prevent the destruction of the impurities in water system, provide the unit reliability.



Feature

Water System Installation Sketch

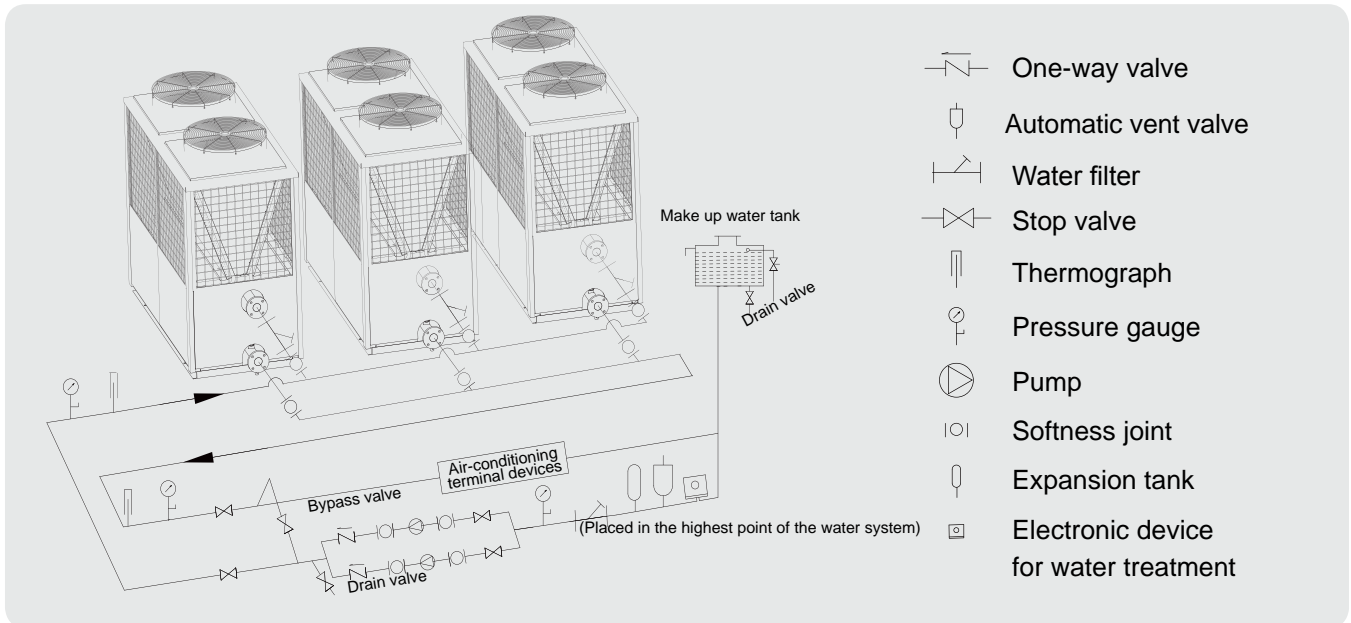

2.2 Technical Features

2.2.1 The modular design, capacity can be broadened.

The unit uses modular design module, a plurality of modules are connected together, the unit can be connected to 16 separate unit module, can be done to expand the width capacity between 65kW-1040kW; at the same time each individual module no distinction between them, both it can be used as a host; also be used as auxiliary use, high design and installation flexibility.

2.2.2 A combination of convenience, balanced operation, automatic control.

When module combination, water pipe and communication line need to connect to each other. The advanced microcomputer control system will automatically achieve uniform load distribution unit, so the unit is always in the best operating condition, and does not consume unnecessary energy. While for the whole unit, the system running time is basically same which can increase the overall life of the unit and operate at low load in some modules.

2.2.3 Efficient intelligent control

Features:

Ability autoregulation

Linkage centralized control technology

Self-diagnostic technology

Lock function

Winterized function

With a strong self-protection and self diagnostic functions:

Compressor high and low voltage protection, power supply reverse (lack of) of protection, frost protection in cooling mode, the unit frost protection in winter water systems, compressor overcurrent protection, compressor discharge temperature protection, anti-overheating protection, flow switches protection, sensor fault protection.

2.2.4 Environmental protection:

R410A refrigerant, higher cooling (heating) efficiency. Improve air conditioning performance, do not damage the ozone layer.

2.2.5 Ultra-wide operating range

50 degrees in ultra-high temperatures cooling, but also can meet the ultra-low temperature of minus 15 degrees in heating operation.

2.2.6 Low noise:

World-class scroll compressor, low noise fan, low noise operation.

2.2.7 Precise throttle mode:

Reliability using electronic expansion throttling way to ensure the system.

3. Specification

Item		Model	CA0070EAND
Nominal refrigerating capacity		kW	65
Nominal heating capacity		kW	70
Nominal refrigerating input power		kW	19.1
Nominal heating input power		kW	19.2
Max. input power		kW	28
Max. operating current		A	55
Compressor	Type	--	Flexible scroll compressor
	Qty.	EA	2
	Rated power	kW	18.3
Capacity regulating range		---	50%, 100%
Refrigerant	Type	---	R410A
	Charge	kg	13
Refrigerant throttling device		---	Electronic expansion valve
Power supply type		---	3N~, 380V, 50Hz
Air-side heat exchanger	Type	---	Slit fin+efficient inner grooved copper tube
	Fan type	---	Axial flow fan
	Fan power	kW	1.5
	Qty.	EA	2
Waterside heat exchanger	Type	---	Shell tube heat exchanger
	Flow	m ³ /h	12
	Water pressure loss	kPa	45
	Connection dimension	---	2"
	Scaling factor	m ² · °C/kW	0.018
Standard pressure-bearing		Kpa	1
Net dimensions	Length x Width x Height	mm	2000x780x2120
Weight	Net weight	kg	630
	Operating weight	kg	645
Safety protection	High/low pressure protection, water-break delay protection, anti-freezing protection, motor overload, overheating protection, phase failure and phase sequence protection.		

Note:

1. Nominal refrigerating condition: water outlet temperature is 7°C, ambient temperature is 35°C, and water flow is 0.172[m³/(h · kW)].
2. Nominal heating condition: water outlet temperature is 45°C, ambient temperature is 7°C for dry bulb and 6°C for wet bulb, and water flow is listed in the above table.
3. Unit operating range: conforming to GB/T 18430.1.
4. Scaling factor of circulating water: 0.018m² · °C/kW.
5. The specifications in the table may vary with changes in product design without prior notice.

Item		Model	CA0130EAND
Nominal refrigerating capacity		kW	130
Nominal heating capacity		kW	135
Nominal refrigerating input power		kW	19.1
Nominal heating input power		kW	19.2
Max. input power		kW	28
Max. operating current		A	55
Compressor	Type	--	Flexible scroll compressor
	Qty.	EA	4
	Rated power	kW	18.3
Capacity regulating range		---	50%, 100%
Refrigerant	Type	---	R410a
	Charge	kg	5.8*4
Refrigerant throttling device		---	Electronic expansion valve
Power supply type		---	3N~, 380V, 50Hz
Air-side heat exchanger	Type	---	Slit fin + efficient inner grooved copper tube
	Fan type	---	Axial flow fan
	Fan power	kW	1.5
	Qty.	EA	4
Waterside heat exchanger	Type	---	Shell tube heat exchanger
	Flow	m ³ /h	24
	Water pressure loss	kPa	60
	Connection dimension	---	2"
	Scaling factor	m ² · °C/kW	0.018
	Standard pressure-bearing	Kpa	1
Net dimensions	Length x Width x Height	mm	2000x1603x2120
Weight	Net weight	kg	1100
	Operating weight	kg	1150
Safety protection	High/low pressure protection, water-break delay protection, anti-freezing protection, motor overload, overheating protection, phase failure and phase sequence protection.		

Note:

1. Nominal refrigerating condition: water outlet temperature is 7°C, ambient temperature is 35°C, and water flow is 0.172[m³/(h · kW)].
2. Nominal heating condition: water outlet temperature is 45°C, ambient temperature is 7°C for dry bulb and 6°C for wet bulb, and water flow is listed in the above table.
3. Unit operating range: conforming to GB/T 18430.1.
4. Scaling factor of circulating water: 0.018m² · °C/kW.
5. The specifications in the table may vary with changes in product design without prior notice.

4. Dimension

Unit: mm

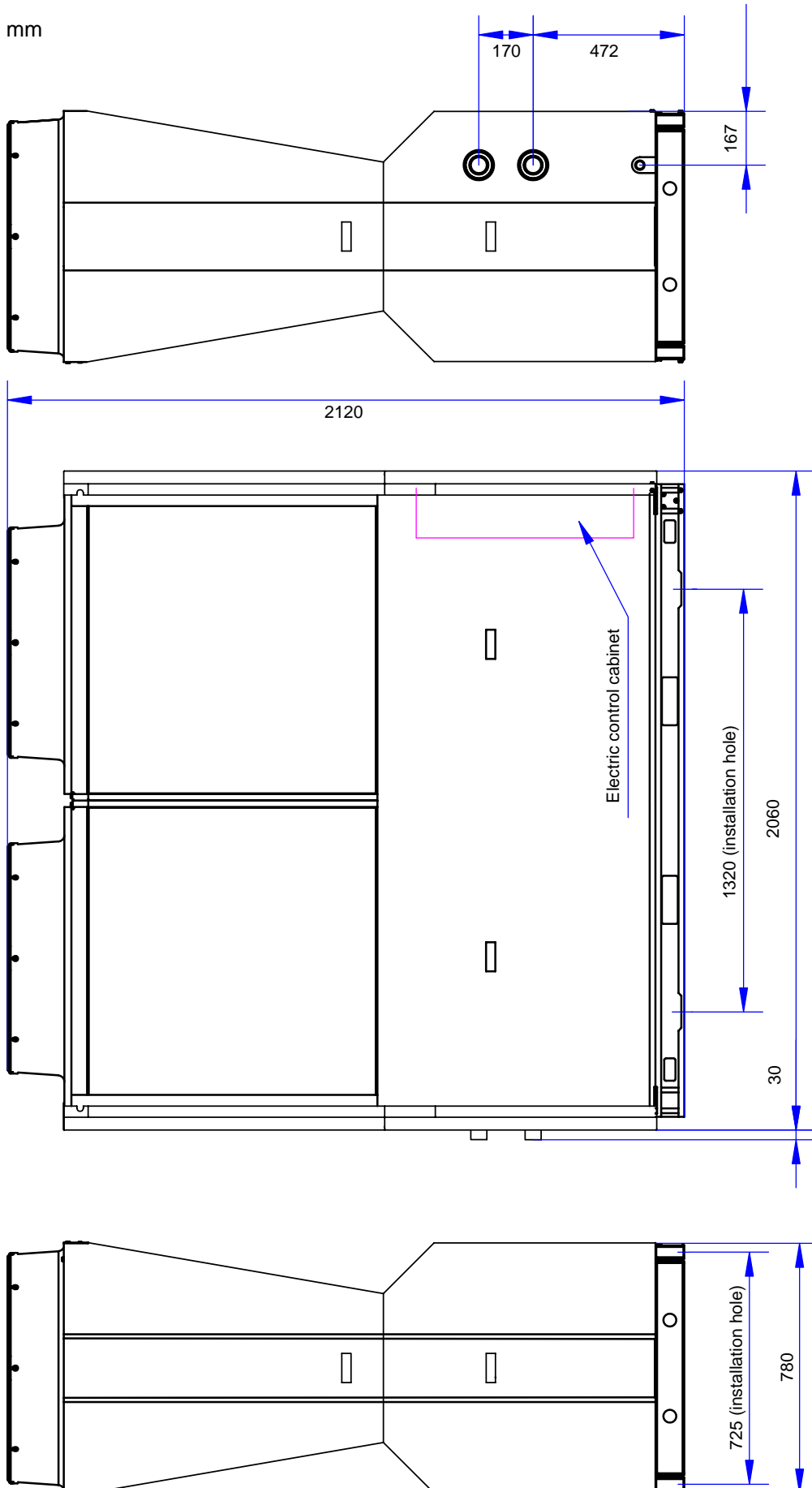

Dimension



5. Installation

5.1 Symbol Precautions

Symbol description

Dear user,

For the better understanding of this Manual and the proper operation of the chiller, the marks and symbols used in this Manual are described as follows:

 WARNING	It is likely to cause death, serious injury and other severe accidents if the user fails to do as required.
 CAUTION	It is possible for severe accident to occur.

WARNING

- Installation and maintenance must be carried out by professionals experienced in this type of unit in accordance with applicable local codes and rules on installation and maintenance. We are not liable for any unit damage or casualty due to non-conformance with this requirement.
- The power supply must be switched off prior to maintenance and relocation of the unit; otherwise, personal injury or death may be caused by electric shock. Do not touch such hot components as compressor and exhaust pipe directly.
- When the water system contains water, control the startup and shutdown of the water pump via the water pump output point on the unit controller; otherwise, the anti-freezing protection of the unit will not work, causing the freezing crack to the heat exchanger. If the unit is to idle for a long time in winter, drain the water from the water system via the drain valve to prevent the freezing crack of the heat exchanger, the water pipe and other parts on water side. Furthermore, the water pump shall be power off to avoid starting up against frost without water.
- To prevent the heat exchanger on water side from being frozen due to foreign matters entered, a self-contained water filter must be installed on the water return pipe of the unit (specific installation position is shown in water system diagram).
- Dregs and dirt in the water pipe network including filter and heat exchanger may seriously damage the heat exchanger and water pipe. Installers and users must ensure the quality of chilled water, not use anti-icing mixtures containing salt and prevent the entry of air into the water system, because the salt and air can oxidize and corrode steel parts inside the heat exchanger.

CAUTION

- No unit is allowed to be installed near such places that are dirty, oily, salty, exposed to a large amount of sulfur gas and where the unit parts may be subjected to corrosion, such as toilet vent, operation room vent and sewage treatment equipment.
- If the unit is operated below 0°C, it must be installed at a place at least 300 mm above the ground, so as to avoid icing of unit base plate and to ensure the normal operation of the unit even though the snow reaches this height; in addition, the unit shall be placed on a plane (with maximum deviation per meter of not more than 2 mm).

5.2 Site requirements

1) Noise considerations

- The unit is placed in the non-noise sensitive areas
 - The damping pad on the unit below (not supplied with the standard model damping pad, user-owned)
 - Install rubber shock absorbers on all water pipeline
 - Seal all wall gap at room
- Note demanding applications should consult an acoustic engineer

2) Ground

Install it on a hard, easy deformation of mounting pads or a concrete foundation to withstand the total weight of the living unit at runtime (including all piping, refrigerant, oil, water). Referring operating weight parameter table. After placing a good unit, machine leader and level of assurance in the width direction should 1/4 "(6.35mm) within. Haier company equipment problems as the basis of design or construction caused inappropriate will not take any responsibility.

3) Shock absorbers

- Provide rubber shock absorbers for the unit all the water pipes (Haier company standard models do not random with shock absorbers, user-owned).
 - Use a flexible tube connecting wire electrical lines.
 - Isolate all pipe hanger to ensure that they are not supported by the main structural beams of the building, so as to avoid vibration transmitted live and work areas.
 - Ensure that the pipeline will not add additional pressure to the unit.
- Be careful not to use metal tube shock absorbers, because the frequency range of plant operation, the damper is ineffective.

4) Frost protection

Note

In the case of low ambient temperature in winter, overnight shutdown period, heat exchangers and water pipes may freeze inside, causing damage to equipment and piping. To prevent freezing, never allow the unit off (because the unit has an automatic antifreeze function), as well as possible icing must put all the water discharge pipe; hot side 65 to increase drainage and air-conditioned sides need to water line installation valve, care must be taken to be installed at the lowest point of the water circuit, if the drainage more difficult case, you can use anti-freeze mixture of ethylene glycol or propylene glycol (ratio table below).

Freezing and boiling points of ethylene glycol solution (anti-freeze glycol concentration table):

Freezing point °C	Glycol concentrations%	Density (20°C)mg/cm ³	Freezing point °C	Glycol concentrations%	Density (20°C)mg/cm ³
-10	28.4	1.034	-40	54	1.0713
-15	32.8	1.0426	-45	57	1.0746
-20	38.5	1.0506	-50	59	1.0786
-25	45.3	1.0586	-45	80	1.0958
-30	47.8	1.0627	-30	85	1.1001
-35	50	1.0671	-13	100	1.113

5.3 Installation

■ Drawing of Overall Dimension

■ Reference Position of Base

1. The bearing capacity of base is designed as per the weight of unit during operation.
2. The base may be of U-steel (designed by users as per overall dimensions of the unit) or concrete structure and shall have flat surface.
3. A 10-20 mm rubber shock pad shall be placed between the unit and the base.
4. The unit and the base may be fastened with $\varnothing 16$ or $\varnothing 18$ anchor bolts.

■ Unit Base Diagram

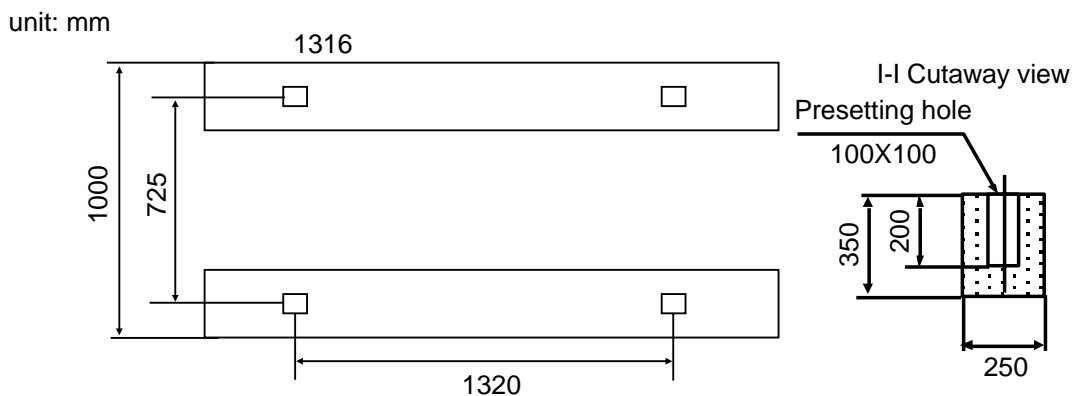

■ Pre-installation Preparation

■ Cargo inspection

All units are firmly bolted on wood trays, subject to ex-factory inspection and filled with accurate amount of R410a refrigerant and refrigeration oil for the unit operation. Upon the receipt, you shall carefully inspect cargoes for any damage during transport and confirm all ordered parts and accessories are delivered.

You shall inform delivery man of any damage immediately. And you shall inform problem to us other than appearance damage immediately.

■ Handling

You shall handle the unit by a forklift or crane. If a crane is used, the top and side panel of the unit shall be protected by appropriate spacers (as shown in the figure). During the handling, the unit shall be kept horizontal and not be inclined for more than 30° , and the unit damage due to violations shall be avoided.

■ Disassembly

Place the unit at a desired position, cut binding tapes, remove the external crate, unscrew bolts and remove the wood base from the unit bottom.

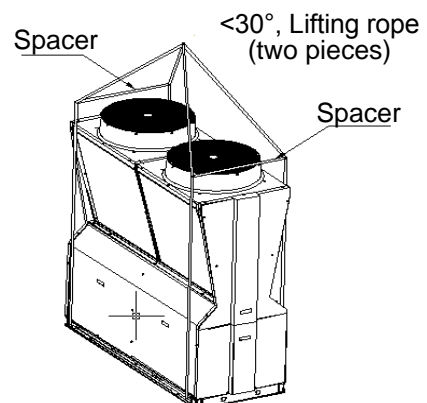

Selection Installation Position

- For the better cooling (heating), the installation position of the chiller unit shall be selected as per the followings:
- The unit shall be installed at a place where the hot air exhausted by the unit is not sucked back, that exhausted by other unit is not sucked and sufficient space is reserved for the unit maintenance.
- Exhaust and suction channels of the chiller unit shall be free of any barrier that will block the air flow.
- The unit is installed at a well ventilated place to improve the heat exchange.
- The installation position shall have enough strength to withstand the unit weight and the vibration during operation.
- The unit shall not be installed at a place that is dirty, oily, salty and exposed to a large amount of sulfur gas.
- The chiller unit shall not be installed at such place where flammable gas may leak. Because the flammable gas leaked and accumulated around the unit may lead to explosion.
- The chiller unit shall not be installed at such a place exposed to strong wind or typhoon or accumulated rainwater and snow. If possible, auxiliary equipment for preventing rainwater, snow and direct sunshine may be provided.
- The unit base shall be made of concrete or support. Full consideration must be given to floor strength, drainage (water is drained from the unit during operation) and pipe and wire route in the base construction. If the base is not strong enough, the unit may fall down, causing unit damage or personal injury.
- The chiller unit shall be firmly fastened with anchor bolts to prevent falling down due to earthquake or strong wind. In order to withstand strong wind and earthquake, the unit must be positioned properly and can not be installed at such a place exposed to strong wind.
- Depending on installation conditions, vibration may be transferred to fitted parts, and base plates and walls may produce vibration and noise. Therefore, proper vibration protections (e.g. setting shock pad, dumper bracket, etc.) shall be provided.
- Edges and corners must be positioned correctly. The improper installation may lead to instability, resulting in bending of mounting feet. Any improper installation may cause the falling down of the unit, leading to personal injury.
- The unit shall be positioned so as to minimize the impact on residences; in case of special requirements for the noise, please contact us.

Installation Space

1. Diagram of installation space for single chiller unit (Unit:mm)

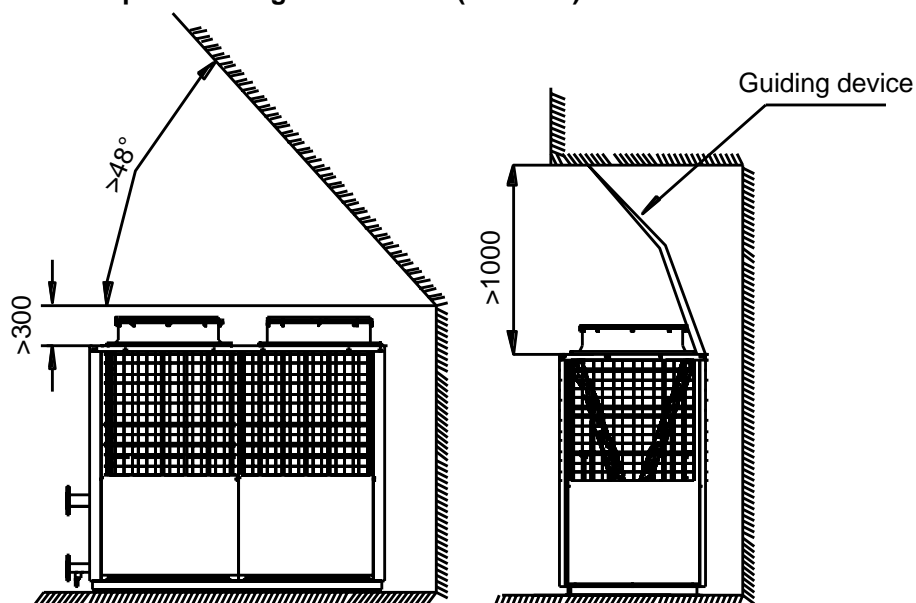

2. Diagram of installation space for multiple chiller units (Unit:mm)

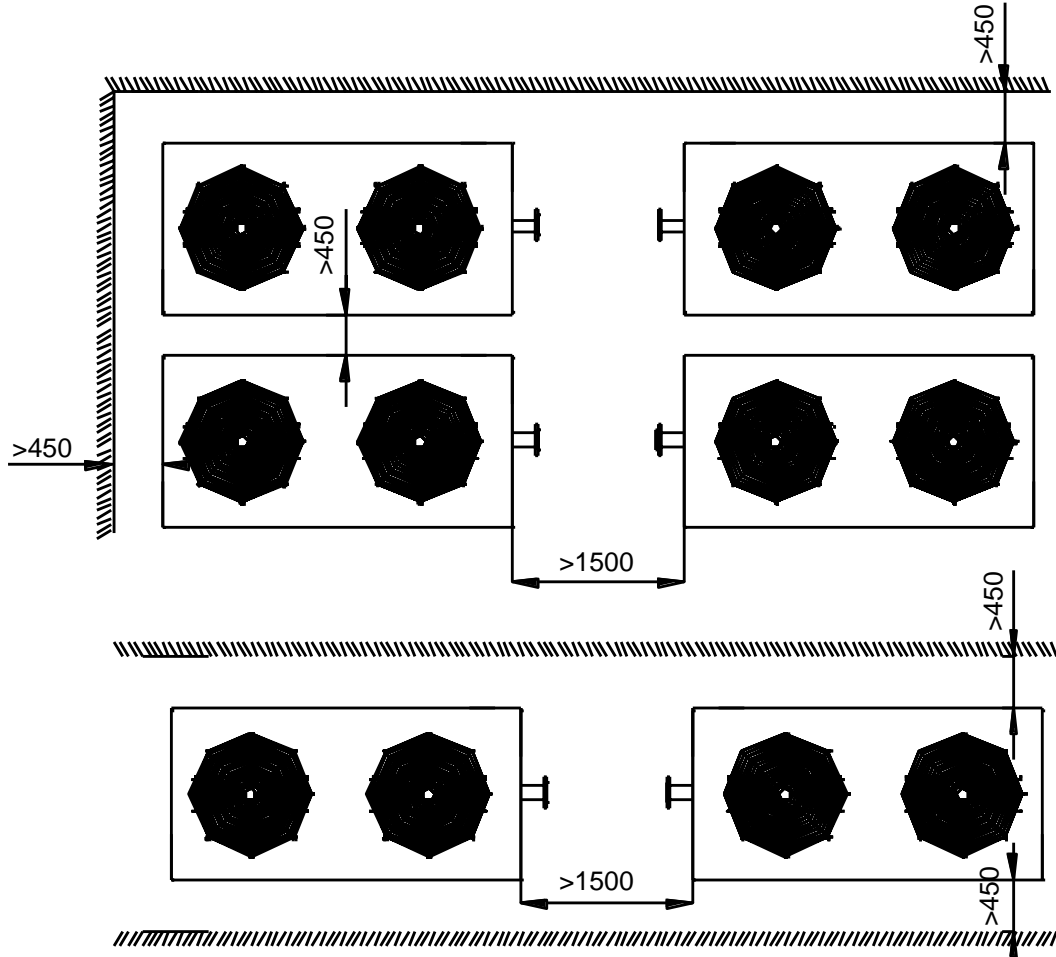

3. Diagram of arrangement of multiple chiller units

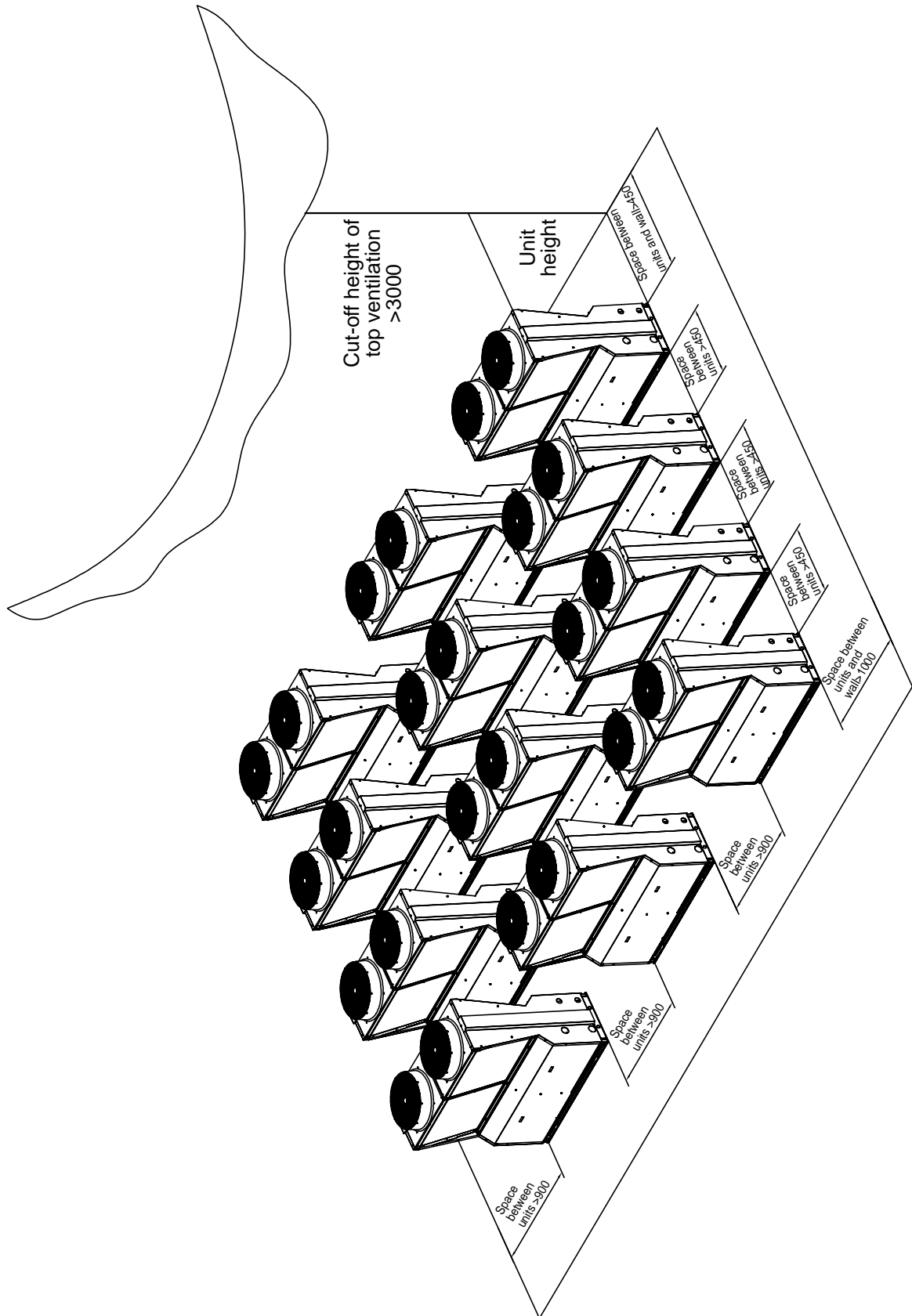

5.4 Water pipe connection and wiring connection

■ Water Pipe Connection

1. External water pipe system must be equipped with flexible joints, water filter, electronic cleaner, check valve, drain valve, exhaust valve, shutoff valve, expansion tank, etc.. The expansion tank shall be located at 1-1.5 m above the highest point of the system; the exhaust valve shall be set between the highest point of the system and the expansion tank, and insulations shall be arranged between the tank and the pipe.
2. Water supply system must be a water pump with appropriate flow and head to ensure the normal water supply to the unit. The circulating water must be softened water.
3. A water filter must be installed in front of the inlet pipe of the unit, and the self-contained water filter also must be installed.
4. The connection between the water pump and the unit and between the water pump and the water pipe shall be realized through flexible joints; in addition, the pipe and the water pump shall be supported separately, so as to not apply any force on the unit.
5. Flushing and heating of water pipe shall be carried out prior to the connection between the pipe and the unit.
6. The drain valve on the outlet pipe is self-contained; manual or automatic exhaust valve shall be set at the highest point of the water circulation system; for the normal operation of the unit, the valve handle must be removed, so that the valve is not adjusted.
7. Water quality control

Industrial water used as hot water is not likely to produce scale; while, well water or river water may produce a lot of scale, sand and other sediments. So, before flowing into the hot water system, the water must be filtrated and softened by water softening equipment. If sand or mud deposits in evaporator, the flow of hot water will be blocked, resulting in freezing; so relevant water values such as PH, electric conductivity, chloride ion concentration, sulfur ion concentration shall be analyzed beforehand. Quality criteria of the water for the unit are shown as follows:

Item		Criteria	Impact factor
Standard	PH	7.5-9.0	○/□
	Electric conductivity	≤200 uv/ppm (25°)	○/□
	Chloride ion	≤50 ppm	□
	Sulfate ion	≤50 ppm	□
	Total iron content	≤0.3 ppm	□
	Alkali ion	≤50 ppm	□
	Total hardness	≤50 ppm	□
Reference	Sulfur ion	N/A	□
	Ammonia ion	N/A	□
	Silicon	≤30 ppm	○

Note: ○ Standing for scale, □ standing for corrosion

WARNING

Never connect unclean pipe to the unit!

- If the unit is to idle for a long time, the water in the water system shall be drained to prevent the plate heat exchanger being iced.
- If the unit is to idle for a short time, the power-off is not allowed, because the unit has automatic anti-freezing function. When the temperature in the outlet pipe is very low, the unit will automatically operate for a period to maintain the temperature of the water system and prevent the water pipe from being frozen, so the unit must be energized in winter. If the unit is not used in winter, drain the water from the water system or fill such anti-freezing mixture as ethylene glycol and glycerol into the water system.
- The water filter must be installed correctly; otherwise, the unit may be damaged. Additionally, the water filter shall be regularly inspected for any blockage due to dirt.

■ Electrical Connection

Before circuit connection, following safety rules and measures must be adhered to:

1. The unit must be installed by our service personnel or specially trained installation personnel. The installation shall be in accordance with applicable national and local laws, regulations and standards on electrical, building and environmental protection, etc., and requirements in the installation manual. Removal or addition of control components is not allowed without permission. We are not liable for any unit damage or casualty due to non-conformance with these requirements.
2. Circuits shall be connected as per "electrical connection". We provide each unit with a wiring diagram, which is located inside the control cabinet.
3. The ground wire of the unit shall be well grounded. The ground wire is not allowed to be connected to gas pipe, water pipe or telephone wire, because improper grounding may lead to electric shock.
4. Before startup, check power supply for compliance with requirements.

■ Operation Inspection

■ Necessary inspection and pre **CAUTIONs** before startup

1. Confirm all electrical connections are firm.
2. Ensure the unit is installed horizontally and sufficiently supported at bottom.
3. Ensure no water seepage occurs and valves operate normally.
4. All screws necessary for panels are installed firmly and securely.
5. Confirm no refrigerant is leaked.
6. Confirm electrical and pipe connection is consistent with the scope shown on unit nameplate, wiring diagrams and other relevant documents.
7. Confirm insulations of all temperature sensors are not damaged.

■ Inspection before operation

1. Ensure power supply is consistent with what required on unit nameplate.
2. Unit circuits are connected. Check whether power supply wire is routed and connected correctly and ground wire is firmly connected. Check interlocking devices of water pump, etc. are connected correctly.
3. Water pipes and relevant pipes. Water pipes and relevant pipes must be flushed for at least two or three times without any pollutant.
4. Check the water circulation system. Check whether water is sufficient and air is exhausted completely, and ensure there is no leakage.
5. Before initial startup or restart after shutdown over a long time, the power supply must be switched on to heat crankcase for at least 12 hours.
6. The water filter is installed as required, and there is no pollutant on the water filter screen.













■ Inspection of operation status

When the unit operates stably, check the followings:

1. Temperature at water inlet of the unit.
2. Temperature at water outlet of the unit.
3. Outlet flow.
4. Operating current of compressor.
5. Operating current of fan.
6. High/low pressure value during cooling (heating).

You may determine whether the unit operates normally on the basis of above data.

■ SCHEMATIC DIAGRAM of WATER SYSTEM

Symbol	Description	Symbol	Description
	Check valve		Water pump
	Automatic exhaust valve		Flexible connection
	Water filter		Expansion tank
	Stop valve		Electronic water processor
	Thermometer		3-way valve
	Pressure gauge		2-way valve

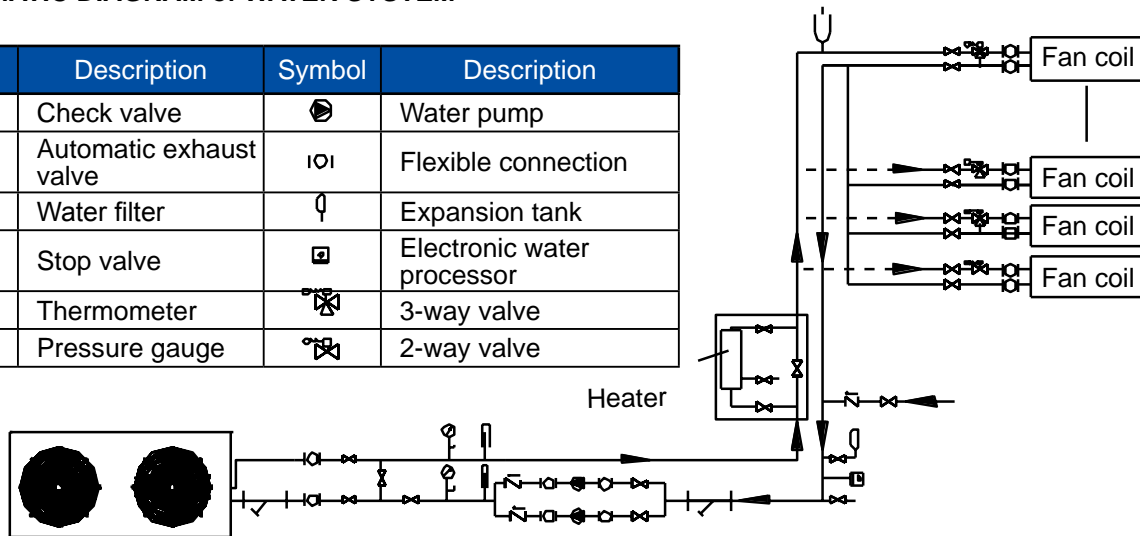

Basic requirements

The chilled water pipelines may be connected as per relevant procedure when the unit is installed in place. Such pipelines shall be free from any foreign matter, and must conform to local piping regulations and rules.

1. Before unit operation, thoroughly flush all chilled water pipelines to ensure that they are free from any foreign matter. Note: Do not flush any foreign matter into the evaporator.
2. Water must flow into the heat exchanger via the inlet. The opposite water direction through the heat exchanger may degrade the unit performance, and give rise to fault in flow switch.
3. The water pump installed in the water pipeline system is equipped with a starter, and directly pumps water into the heat exchanger of the water system.
4. Tubing and connectors must not be mounted on the unit but independently supported.
5. The nozzles and connectors of the heat exchanger shall be easily disassembled for operation, cleaning and inspection over the evaporator nozzle.
6. The evaporator is provided with a 40-mesh filter, which must be installed at the water inlet of the unit and insulated (see the above diagram).
7. The heat exchanger ports and the site pipelines shall be flexibly connected to reduce vibration transmitted to buildings.
8. To facilitate troubleshooting, a thermometer or pressure gauge shall be installed on the water inlet and outlet pipelines. Pressure or temperature instrument are not provided with the unit and are at users' own expenses.
9. Drain ports shall be arranged at all low points of the water system to ensure that water in the evaporator and the system is completely discharged; exhaust valves shall be arranged at all high points to vent air in the pipelines. The exhaust valves and drain ports are not insulated for easy troubleshooting.
10. All water pipelines in the system exposed to frost shall be thermally insulated.
11. Outdoor chilled water pipelines shall be covered with an auxiliary heating tape and insulated with 20 mm thick thermal insulation material, so as to avoid frozen or ruptured pipelines due to low temperature. The power supply of the heating tape shall be equipped with a separate fuse.
12. Where the ambient temperature is below 0°C, or the unit is to idle for a long time, please discharge water from the unit through the water outlet pipeline connected with the plate heat exchanger of the unit. If no water discharge is required for the unit in winter, do not cut off the power supply. The fan coil in the water system must be provided with a 3-way valve to ensure that the water system is smoothly circulated after the winterizing water pump is started.

CAUTION

- The bypass pipes and stop valves of water inlet and outlet pipelines shown in the above diagram must be installed to facilitate cleaning of other systems outside of the water pipeline prior to the unit commissioning. During maintenance, the water pipelines of the heat exchanger may be cut off without interference to other heat exchangers.

■ Overall Nozzle Dimensions during Module Combination

(Maximum 16 modules combined)

Number of modules	2	3	4	5	6	7	8	9	10	11	12	13	14	15	16
Doverall nozzle dimensions (mm)	65	80	100		125		150			200			250		

■ Calculations of Water System Inventory

CAUTION

- During unit operation, the actual operating capacity of the water system is less than the minimum water capacity required, resulting in frequent alarm and shutdown of the unit.

Model of unit	Preset return water temperature (°C)	Minimum effective water capacity Vmin. (l)
CA0070EAND	12	210
CA0130EAND	24	420

CAUTION

- The effective water capacity of the running water system includes the total capacity of the water main, water tank, 2-way valve normally-open end which are involved in water circulation in the water system.
- The actual effective water capacity (V) of the running water system must be more than or equal to Vmin., otherwise the unit may be subject to frequent alarm or shutdown!

Calculation example of water system capacity

Assume that one wr system is paterovided with two sets of LSQWRF65/R2A units, and the preset return water temperature is 12°C. The diameter of water main is DN65, and the total length of water inlet & outlet pipelines is 80m. Eight end fan coils are normally open. The internal capacity is 2L.

Calculations:

Capacity of inlet & outlet water mains = $3.14 \times \{(65/2)/1000\}^2 \times 80 \times 103 = 265L$

Water capacity of end fan coil = $10 \times 2 = 20L$

The above table indicates that the required minimum capacity of the water system Vmin.=310L

To avoid frequent startup, shutdown and alarm of the unit, the capacity of water tank must be more than or equal to Vmin.=310-265-20=25L

■ Type Selection of Auxiliary Electric Heater

According to engineering requirements, it is recommended that one set of auxiliary electric heater be used as standby system, which is started to keep water temperature of the unit in case of defrosting or temporary fault of such equipment.

Considerations on type selection of auxiliary electric heater mainly include the minimum average outdoor ambient temperature in winter and the capacity of standby system. Based upon the local minimum average ambient temperature in winter and the water outlet temperature of the unit, the unit capacity attenuation Q2 can be obtained via comparison between the capacity Q1 from the "Performance Correction Curves" and the nominal capacity Q of the unit.

$$Q2 = Q - Q1$$

The capacity of auxiliary electric heater generally selected, W

$$W = a * Q2 = a * (Q - Q1)$$

In which, a refers to margin coefficient, taking between 1.0 and 1.5, and it is larger in northern area, e.g. taking 1.5 in Hubei province and its northern area.

⚠ CAUTION

- In heating mode, the unit capacity may drop with the decreasing ambient temperature, thus users shall add the auxiliary electric heater at the hot water side for the areas under the low average outdoor ambient temperature in winter, otherwise the unit performance may be affected.

■ Electrical Connection

1. Connection diagram of the unit power cords

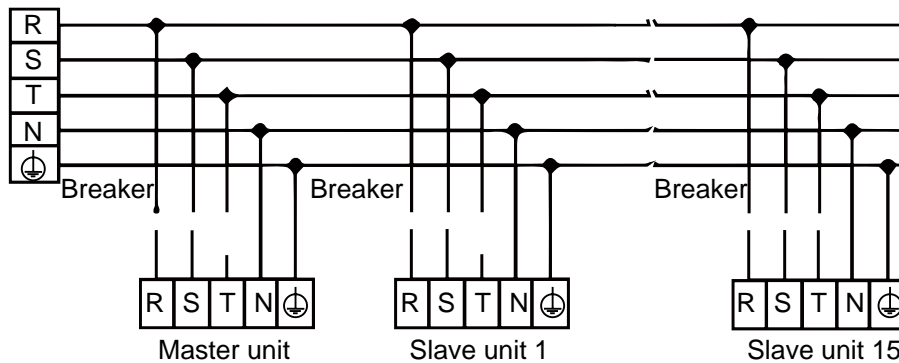

⚠ CAUTION

- The breaker with sufficient capacity must be arranged at the entry of power cord. Such breaker shall be protected against short circuit and earth fault, and its contact spacing is at least 3mm. Please install it by yourself.

■ Control of auxiliary electric heater

The electric heater is started to provide the auxiliary heating function under the low temperature. The water inlet & outlet of the auxiliary electric heater are connected in series to the outlet water main of the modular air-cooled chiller unit, with control contacts of the auxiliary electric heater provided in the electrical cabinet of main module of the unit (only 220V output control signal provided, and the control part of electric heater equipped by users).

■ Operation control of water pump (to ensure normal operation of the unit, linkage control of the water pump and the unit must be used)

The linkage control contacts of chiller water pump are arranged in the unit control cabinet (only 220V output control signal provided, and the control part of water pump equipped by users). If the unit is in standby state, the water pump is not started; if the standby unit is switched to running state, the water pump is started firstly; if the running unit is switched to standby or shutdown state, after completion of operation, automatic shutdown of the water pump may delay.

Note: where multiple units share one set of water pipeline system, after the unit is started, all water pumps (except for standby pumps) are started, and the number of running water pumps is independent of the number of running units. Selection of water pumps shall be in accordance with requirements of units: the water flow and the nominal water flow on the nameplate shall not exceed $\pm 30\%$.

■ End linkage control

The passive normally-open contact (open if the end controller is disabled; and closed if it is enabled) of the end controller is connected to the linkage contact of the main module (LINE, 0V). When the unit is enabled, if at least one end controller is enabled, the unit automatically starts; if all end controllers are disabled, automatic shutdown of the unit may delay. If the unit is not provided with end linkage control, LINE, 0V shall be short-circuited.

2. Electrical parameters

Mosel of unit	Rated current	Maximum current	Locked-rotor current	Refernce cable sectional area
CA0070EAND	32.5A	55A	(155x2) A	5x10 mm ²
CA0130EAND	75	110	(155x4) A	4x50mm ² +25mm ²

Note:

the working voltage of the unit must be kept within $\pm 10\%$ of the rated working voltage. If the power wiring distance is too long, the power cord diameter shall be increased under the guidance of professional electricians in accordance with the technical data provided by the cable manufacturer.

3. Requirements for Communication Wires

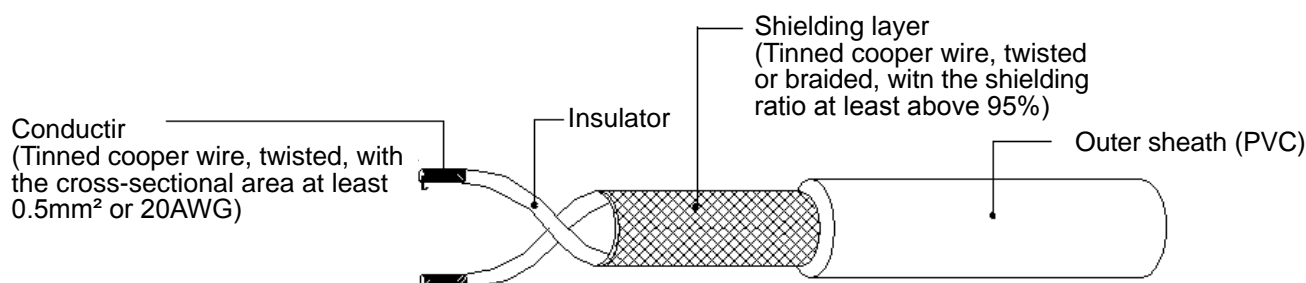

Description:

1. The network connecting wires with compact shielding layer and small lay of twisted conductors shall be selected to the greatest extent.
2. Refer to UL2547 or UL2791 wire standards.
3. The length of control wire shall not exceed 1000 m.
4. The control wire routing must be more than 200 mm away from the heavy-current installations.

4. Connection of Communication Wires

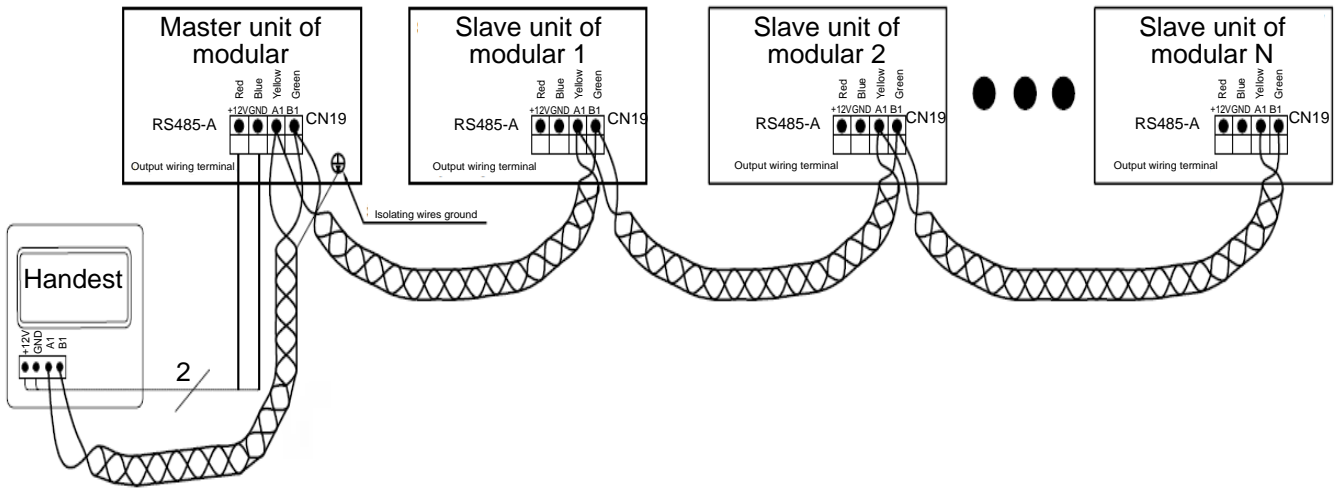

5.5 Waterway design.

Each pipe joints are posted out of the water mark, even when the tube should pay attention to do the following:

- 1) Modular units of air conditioning water-side heat exchanger should be on-site installation of a 40-mesh or mesh diameter of less than 1.0mm mesh Y filter (side must have its own air conditioning filter with unit,) the filter should be installed in as close to the inlet connection of the position and be warm.
- 2) The heat exchanger must be installed bypass pipe and a bypass valve so that unit before commissioning external water system cleaning. During the maintenance period, it can be cut off without interfering with other heat exchanger waterways; took heat exchangers and pipe joints should be easy to remove, easy to operate and clean, while easy to check the evaporator mouthpiece.
- 3) To facilitate maintenance, it should be into the outlet pipe on the way a thermometer or pressure gauge. Units not equipped with pressure and temperature instruments, users need to buy their own.
- 4) The flow through the inlet into the heat exchanger must. As the opposite direction of flow of the heat exchanger unit performance will be poor.
- 5) On the water side of the heat exchanger inlet pipe, a flow controller must be installed in order for the unit to achieve disconnection protection. Now cooled module total heat recovery unit on the whole target type flow controller as standard
- 6) The pump is installed in the water system needs with a starter. Hydraulic pump directly into the heat exchanger water systems.
- 7) The water in front of the user with the unit connected, the entire piping system must be cleaned. See "Commissioning" section. Then remove the filter strainer clean and reloading, make sure none of the particles and impurities pipeline before connecting with the unit.

- 8) And the unit is connected to the inlet and outlet pipe joints should be soft joints, vibration generated when the work so that the unit is not transmitted to the line.
- 9) In order to ensure the normal operation of the water system, the expansion tank should be installed. To ensure that the first open and then open the pump unit, the unit should be installed in the flow switch on the water mains, and lead to the host's W1, W2 terminals on.
- 10) All low position water drainage system should be set up interfaces, the evaporator and the water in the system to completely exclude; all positions high point vent valve shall be provided in order to remove the air duct. Exhaust valve and the outlet of the heat does not make for easy maintenance.
- 11) The unit normal operation, the valve handle must be removed to ensure that the valve can not be opened, as the unit is running the drain valve open by mistake, an accident can occur without water.
- 12) On the water side of the water, an auxiliary heating tape to wrap and insulate (wrapping insulation material thickness of 20mm) to prevent pipes freezing at low temperatures the cracking and to prevent condensation on the pipe surface. Including connection pipes and flanges of the heat exchanger. Plus tropical power shall be provided with a separate fuse.
- 13) When the water-side industrial water use will rarely produce scale, but use well water or river water will produce more scale and sand and other sediment. Therefore, these water before flowing into the chilled water system must be filtered and softened with demineralized water equipment. If sand and mud deposited on the evaporator, will block the flow of chilled water, leading to the freezing of the accident, it should analyze water quality, such as PH value, conductivity, chloride concentration, sulfur ion concentration prior to use.

6. Controller Operation Instruction

6.1 Description of controller panel

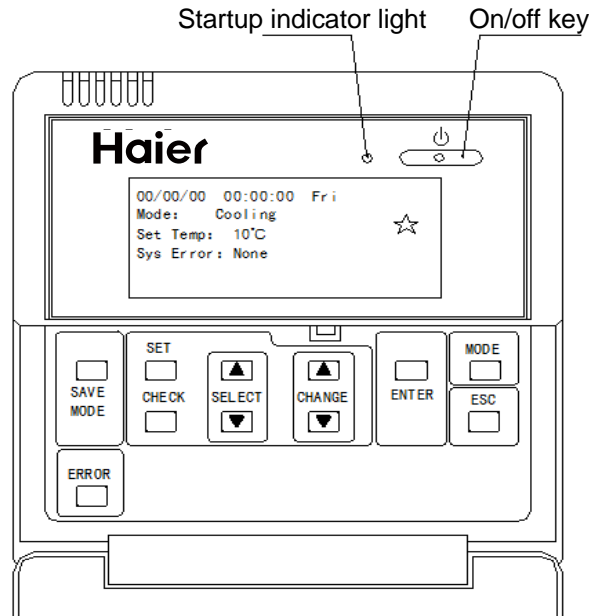

■ Key description of wired controller

1. [On/Off] key: this key is used for the system on/off control; if the initial status is "off", and the system is started up when pressing this key once, and vice versa. During the startup, the LED indicator light (green) is on.
2. [Mode] key: this key used is to change the system operation mode; once pressed this key, the operation mode is switched between cooling and heating.
3. [Power Save] key: this key is to operate the system in "Power Save" mode; if pressed this key, the target temperature of return water is set at 15°C and 37°C respectively for cooling and heating.
4. [Modify] key: this key used is used to adjust setting parameters; press ▲ or ▼ on the [Modify] key to increase or decrease setting parameters; when the wired controller is not in setting mode, this key is used to set the return water temperature and passwords.
5. [Set] key: press this key to enter the parameter setting interface; after logging into the parameter setting interface, general items (set time/timing mode/set timing) and special items can be set.
6. [Select] key: this key is used to select setting items; press ▲ or ▼ on the [Select] key to select items, and the selected character object is displayed on a black background.
7. [Ok] key: this key is used to confirm the setting items; you can press this key to select a setting item and enter the corresponding parameter setting interface.
8. [Exit] key: this key is used to exit (back); the system returns to the previous interface after each press and finally returns to the main interface of the wired controller.
9. [Query] key: this key is used to query the parameter interface of the modular unit; after logging into the parameter query interface of the modular unit, press ▲ or ▼ on the [Modify] key to select the address of the queried modular unit, and press ▲ or ▼ on the [Select] key to query the electrical performance parameters and operation conditions of the modular unit.
10. [Fault] key: this key is used to query the fault of the modular unit and log into the fault query interface.

■ Description of Basic Operation of Wired Controller

1. Once powered on, the wired controller displays a startup password input interface; and the operation can be done only after the input of correct startup passwords. (please consult Haier's after sales service personnel for initial passwords).
Note: initial passwords are not set for some types of units.
2. If you want to start up the modular unit, press the [On/Off] key on the wired controller, then the system starts up and operates in the set mode, and the startup indicator light turns on.
3. The operation mode is generally selected via the [Mode] key prior to the startup, and the mode switch is allowed during the system operation; the system can automatically shut down, and then it can start up and operate in the new operation mode.
4. In the main interface, directly press the [Modify] key to change the target temperature of the return water; the modification range is 10-25°C and 25-50°C respectively for cooling and heating. The optimal set temperature is 12°C for cooling and 40°C for heating.
5. Users can operate the system in the "Power Save" mode through pressing the [Power Save] key; in the "Power Save" mode, the target temperature of return water is set at 15°C for cooling and 37°C for heating.

6.2 Description of controller panel

1. Upon power on, the wired controller displays the main interface first.

Date and time is displayed in the first line: MM/DD/YY hour/minute/second day of the week

Set status is displayed in the second line:

Set mode; you may press the [Mode] key on the wired controller to switch the cooling/heating mode;

Linked switch status; ☆ is displayed in closed status; ☆ is not displayed in open status;

Set temperature is displayed in the third line:

In heating mode, press ▲ or ▼ on the [Modify] key to set the temperature within 25°C-50°C.

In cooling mode, press ▲ or ▼ on the [Modify] key to set the temperature within 10°C-25°C.

[Timing] icon is displayed only the timing is valid on the same day.

Current fault is displayed in the fourth line:

The current fault codes and the address of fault unit are displayed. If a module has several faults, the fault with a small code is reported in a priority manner; if several modules are fault, the fault with a small module address is reported in a priority manner.

Main interface

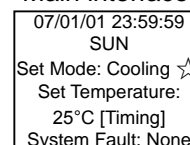

2. Press the [Set] key to enter the main item setting interface.

The first three items on this interface are general items set by users, while the fourth item is a special item set by professionals

Main item setting interface

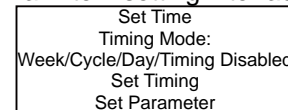

- 1) When you press the [Select] key to select the set time item, the set time is displayed on a black background; you may press the [Ok] key to enter the time setting interface.





You may press ▲ or ▼ on the [Select] key to select the modification item:

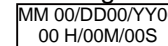





Hour/Minute/Second on MM/DD/YY. The selected modification item is displayed on a black background. Press or on the [Modify] key to set corresponding values; upon the modification completion, press the [Ok] key to update and the system will return to the main interface. The timing is displayed on the main interface based on the modified time.



Time setting interface



- 2) Press ▲ or ▼ on the [Select] key to select the timing mode, the selected timing mode is displayed on a black background; press ▲ or ▼ on the [Modify] key to switch among Week/Cycle/Day/Timing Disabled modes. Upon the completion of setting, press the [Exit] key to return to the previous interface, and the system completes the setting and adjustment of timing mode.
- 3) When you press ▲ or ▼ on the [Select] key to select the set timing item, the set timing is displayed on a black background; you may press the [Ok] key to enter the timing setting interface:

a. If Week Timing mode is selected, the following interface will be displayed. You may press  or  on the [Select] key to select Scheduled Startup/Shutdown from Monday to Sunday and over two periods a day, the selected setting is displayed on a black background, and you can press  or  on the [Modify] key to change the time. Upon the completion of setting, press the [Exit] key to return to the previous interface, the setting and adjustment of Week Timing mode is finished. Detailed steps are as follows:

Press  or  on the [Select] key to select a timing item, the setting item selected by the cursor is displayed on a black background, and then press  or  on the [Modify] key to set the time; the set time is increased or decreased by one minute for each press  or  on the [Modify] key, until the number is 60, the time is increased or decreased by a hour; the display of "--:--" means invalid timing.

When the setting of four columns on this interface is finished, press  or  on the [Select] key again to enter next interface and set relevant items in the same way; and press the [Exit] key to return to previous interface after the setting completion.





Upon the setting completion, the system unit will always start up or shut down at scheduled times set in the Week Timing mode.

Note: when you press the [Modify] key for one second, the set time will continuously increase or decrease.

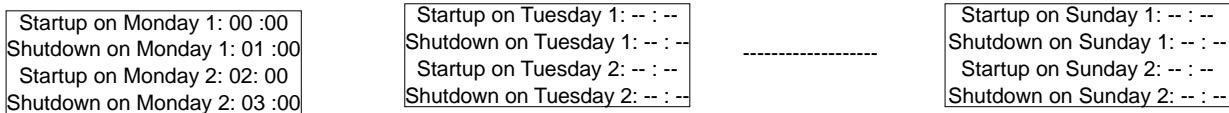
Interface of Week Timing

Mode



b. If the Cycle Timing mode is selected, the following interface will be displayed. When you press  or  on the [Select] key to select set items, the selected setting column is displayed on a black background; and then you may press  or  on the [Modify] key again to set the time. Upon the completion of setting, press the [Exit] key to return to the previous interface, the setting and adjustment of Cycle Timing mode is finished.

Upon the setting completion, the system unit will start up or shut down at scheduled times set in the Cycle Timing mode on daily basis.

Interface of Cycle Timing mode

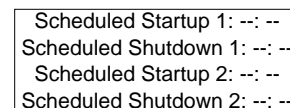

c. If the Day Timing mode is selected, the following interface will be displayed. When you press or on the [Select] key to select set items, the selected setting column is displayed on a black background; and then you may press or on the [Modify] key again to set the time. Upon the completion of setting, press the [Exit] key to return to previous interface.

After the function of the Day Timing mode is enabled, the system exits the timing function

Interface of Day Timing mode

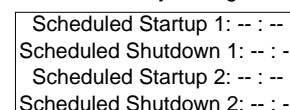

d. If the Timing Disabled mode is selected, the system will disable the timing function, and you can not enter the timing setting interface.

7. Wiring Diagram

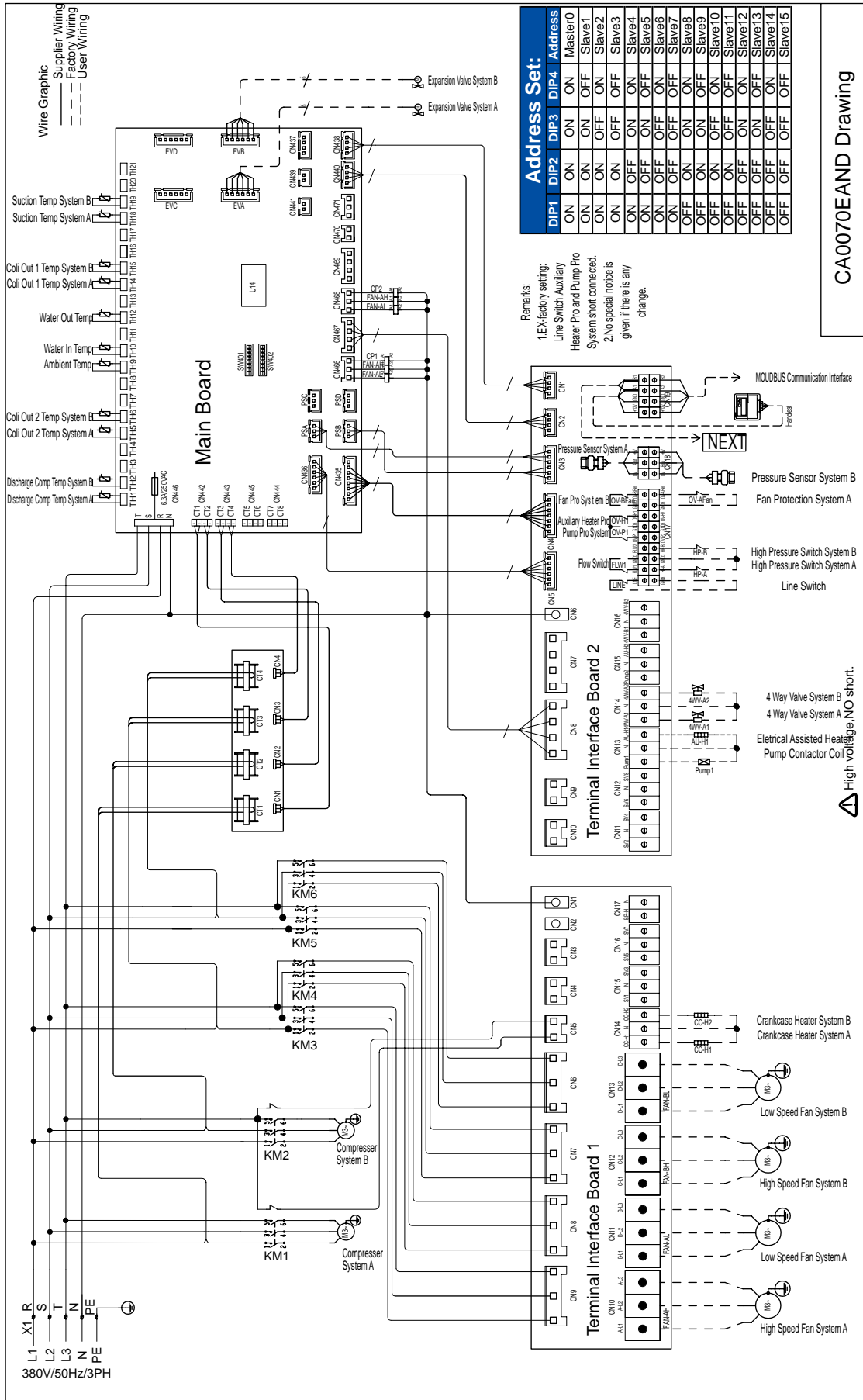

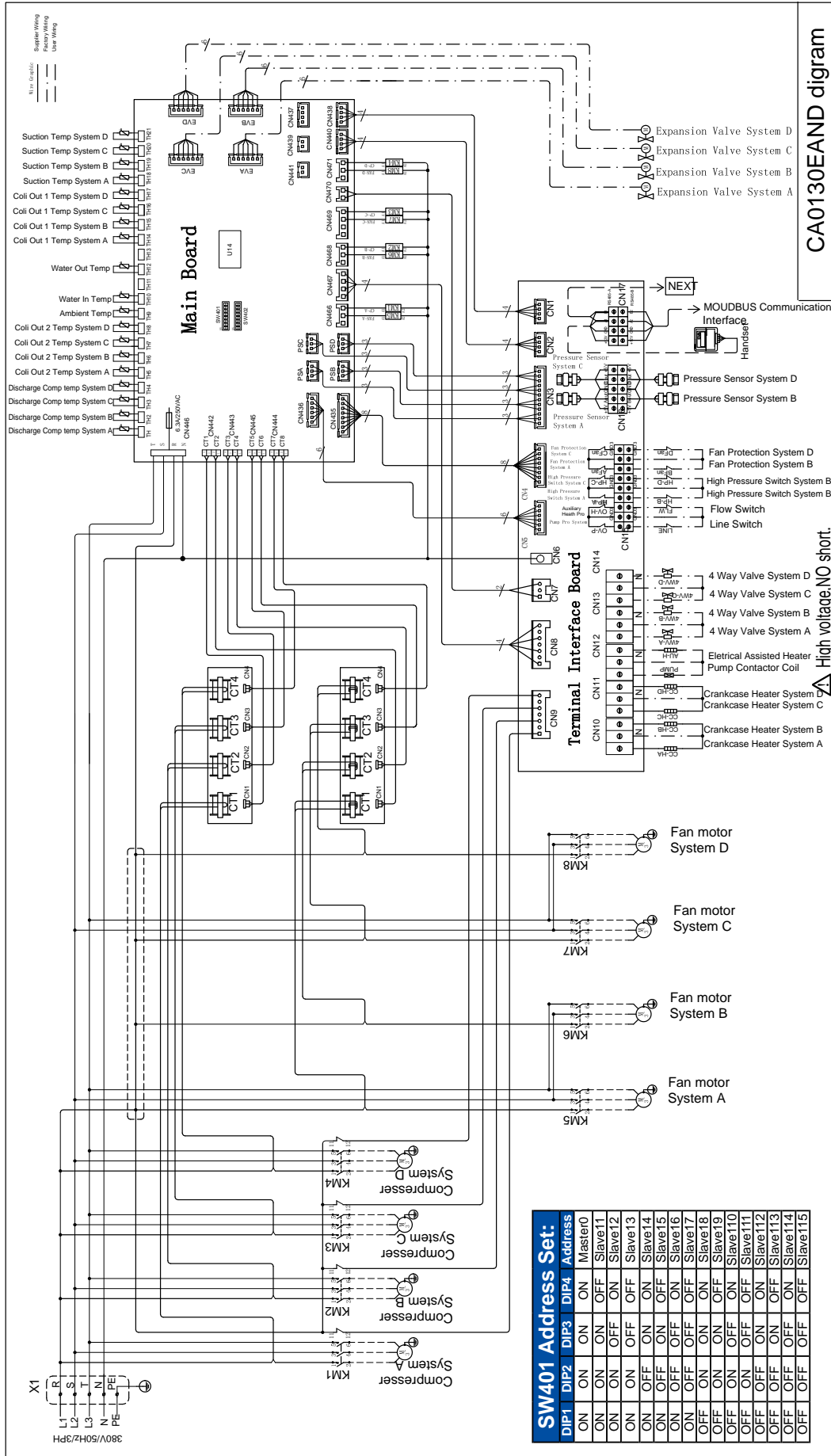

8. Commissioning, Operation and Maintenance

8.1 Unit commissioning

The steps of:

- 1) The wired remote operating power, if found fault code display unit, first eliminate the fault, confirm trouble-free unit, And then start the unit.
- 2) Test run for 30 minutes, out of the water temperature is stable, adjust the water flow to the nominal value, to ensure the normal operation of the unit.
- 3) After the unit is running, running current inspection unit, operating pressure, pressure water system, water flow, and out of the unit Poor water temperature parameters, and the actual situation on the water flow be adjusted to ensure that the unit is operating properly.
- 4) According to the actual weather conditions parameter unit operation, referring to the unit's operating instructions, optimizing the setting unit Parameters to achieve the best working conditions of the unit.
- 5) After the shutdown interval of 4 minutes and then put into operation, in order to prevent frequent starting unit.

Note

- 1) *Because the host can start and stop the pump control, when the water system flushing, the pump can not be controlled by the host Run.*
- 2) *Water system is not sufficiently unprecedented row, can not open the unit.*
- 3) *The flow switch must be installed correctly, or it may occur without water failure.*
- 4) *After commissioning the unit shut down intervals of less than four minutes, shall be manually turned on again.*
- 5) *In the regular season operation after stopping the operation of the unit, do not turn off the power, otherwise the compressor can not get heating, It may cause damage to the compressor.*
- 6) *When the compressor is stopped for long periods of operation and cut off the power, remember to re-operate 12 hours before the crew should energize, to Preheating the compressor.*
- 7) *Commissioning and maintenance may refer to the project schedule, and prepare documented.*

8.2 Operating instructions

Users at every turn, strictly follow the steps specified in the instructions sequentially operations to ensure human, machine safety. The first start operation should be conducted under the guidance of the company commissioning engineers.

- 1) In accordance with the requirements, connect all of cable (wire), internal inspection cabinet and compressor terminal is solid, if loose, retighten.
- 2) The power unit will preheat compressor lubricants for more than 8 hours;
- 3) Open the terminal equipment and check its functioning properly;
- 4) Open system circulating pump, check the operation direction, check the water system is normal;
- 5) Check the expansion tank of water, turn on the system water circulation passage of the exhaust valve, exhaust air despite the Tao;
- 6) Before turning the unit must be inside the various manual valves fully open.
- 7) Make sure the power cord is firmly connected, no phase, out of phase problems.
After completion of the above work, until the water temperature reached the requirements, you can start the terminal equipment into normal cooling operation.

First, before starting preparations

1. After repeated flushing water system piping sewage, water quality cleanliness confirm compliance with the requirements, the system again after emptying open water pump, confirm the water flow, the outlet pressure to meet the requirements.
2. Make sure the pump wiring and phase sequence are correct. Because the pump wiring external wiring, so the control panel can not phase sequence and phase loss conditions were detected pump, so make sure the wiring is correct.
3. The air piping system must be completely excluded. After Luke give water pipes and exhaust air from the empty place, to be almost ruled out air, and then open the pump emptying, with or without air pump operation can listen to the voice, if it is a burst of buzz, or pump outlet pressure gauge pointer swing violently, then the system is still air, we need to stop the pump repeatedly ruled out open air. Remember: If a lot of air, not a long time water.

8.3 Unit Maintenance

Do not take short circuit protection device, it may cause an accident.

1. The main component maintenance

During operation of the exhaust system should pay close attention, suction pressure, such as abnormal timely find out the reasons, troubleshooting.

Control and protection equipment in the field not to freely adjust the set point.

Periodically check the electrical connections for loose contact point oxidation, caused by foreign objects is bad, if to be a timely manner. Often pay careful attention to the operating voltage, current and phase balance.

Timely check the electrical device reliability, and failure to respond timely replacement of unreliable devices.

2. Cleaning

After the long run, the water side of heat transfer surface will be deposited calcium oxide or other minerals, these minerals at higher heat transfer surface fouling, can affect the heat transfer performance and lead to increased energy consumption, exhaust gas pressure is too high (or suction pressure too low). Cleaning may be an organic acid as formic acid, citric acid, acetic acid and the like. Never use chlorine acid or fluoride cleaning agents, due to the water-side heat exchanger material is stainless steel, easy to corrosion, resulting in refrigerant leak.

Clean water side of the heat exchanger shall be professionals. Please contact your local customer service center haier air conditioning.

After using a cleaning agent, clean water with clean water and a heat exchanger, water treatment system to prevent water corrosion or scale re-adsorption after cleaning.

In the case of cleaning agents, according to the deposition of dirt adjust the concentration of the cleaning agent, the cleaning time and temperature, at the same time, after the completion of the associated need for passivation.

After the completion of acid-washed clean, the need for ongoing and waste treatment, waste reprocessing must contact the waste disposal company for waste processing.

Cleaning agents and neutralizing agent to the eyes, skin, nasal and other corrosive effect, so you must use the cleaning work protection device (such as goggles, protective gloves, protection shoes, protection mask, etc.) to avoid inhalation or contact with these agents.

3. Winter shutdown

When the winter shutdown, clean the inside and outside surfaces of the unit, and dry, to dust, the unit should be covering, playing open valve, put the water in water purification and water-side heat exchanger inside, to prevent freezing of the accident. The best injection antifreeze in the pipes.

4. Stop the initial start

After any downtime, subject to the following preparations when the unit is started again:

Thorough inspection and cleaning unit

Clean water piping system.

Check the pump, regulator valve and other equipment plumbing system.

Tighten all wire connections.

5. Parts replacement

Haier fitting replacement parts should be used, not just the same as any replacement parts.

6. The refrigeration system

By checking the intake, exhaust pressure value to determine whether the injection refrigerant and leak detection, leak or replace if

Refrigeration cycle system components tightness test should be carried out, filling the refrigerant in the following two cases should be treated differently.

7. The refrigerant is completely leak

If this happens, the system must use high-pressure nitrogen (15 to 20 kg pressure) or refrigerant leak detection, such as the need for welding can be welded must be drained of gas within the system before the refrigerant charge the entire cooling system must be completely dry and vacuum.

- 1) The suction side of the compressor and the tank side connection Fluoridated mouth vacuuming while ensuring that all of the electromagnetic valve in a power state that is open.
- 2) Use a vacuum pump vacuum system piping, confirm whether the meter refers $-1.0 \times 10^5 \text{Pa}$ (-76cmHg).
- 3) To achieve the required degree of vacuum, refrigerant bottle charging refrigerant to a refrigeration system, an appropriate amount of refrigerant charge on the nameplate and main technical parameters have been stated. Refrigerant charge of the system must be low-pressure pipe side, while opening the pump cycle, avoid the cracking of heat transfer tubes. .
- 4) The amount of refrigerant charge is affected by ambient temperature, if the charge amount does not meet the requirements, you can make frozen water cycle, and start the unit were filled, if necessary, the pressure switch temporarily shorted.

Note:

After filling end must restore wiring.

8. Add refrigerant

Fluoridated mouth in the low pressure side of the refrigerant charge connection bottle, and the low pressure side connection pressure gauge.

The water side of the cycle, and start the unit, if necessary, pressure switch shorted.

Slow charging refrigerant into the system and check the suction and discharge pressure.

Warning: When performing leak detection and tightness test, do not filling oxygen, acetylene or other flammable or toxic gases into the cooling system, use only high-pressure nitrogen or refrigerant.

9. Disassemble compressor

Such as the compressor needs to be removed, follow these steps:

- 1) Turn off the power supply unit.
- 2) Remove the compressor power cable.
- 3) The refrigerant recovery system.
- 4) Remove the compressor suction and discharge pipes.
- 5) Remove the compressor fixing bolt.
- 6) Remove the compressor.

10. The system antifreeze

If the water-side heat exchanger flow path icing conditions, would cause serious damage, appears water-side heat exchanger rupture and leak, and the cracking damage is not covered under warranty, so the frost to special care, for the following three Please pay special attention to the user:

If the unit on the outside temperature is below 0°C environment should be water-side heat exchanger in the water drained in lower ambient temperatures down back.

Runtime may result in runtime if the chilled water flow switch and antifreeze temperature sensor failure pipes freeze and, therefore, the flow switch must be wired according to the wiring diagram.

When maintenance to the unit refrigerant charge or for maintenance and let go of the refrigerant, it is possible the cracking water-side heat exchanger.

Whenever the pressure vessel at 0.68MPa or less refrigerant, piping icing is likely to occur, therefore, make sure to keep the heat exchanger water flow or put a clean water thoroughly.

8.4 Units antifreeze

- 1) Try UPS unit;
- 2) The pump must be linked with the unit can be used to automatically control frost;
- 3) If the water-side heat exchanger flow path icing conditions, would cause serious damage, which occurs plate heat exchangers or shell and tube heat exchanger rupture and leak, and the cracking damage is not covered under warranty, so the antifreeze should give special attention to the following three points please users pay particular attention to:
 - 4) At lower ambient temperature if the unit on the outdoor temperature is below 0 °C environment shutdown should spare the water-side heat exchanger in the water drained.
 - 5) The runtime will likely result in runtime if the chilled water flow switch and antifreeze temperature sensor failure pipes freeze and, therefore, the flow switch must be wired according to the wiring diagram.
 - 6) When the maintenance unit to the refrigerant charge or for maintenance and let go of the refrigerant, it is possible the cracking water-side heat exchanger or shell and tube heat exchanger.
 - 7) Whenever the pressure vessel at 0.68MPa or less refrigerant, piping icing is likely to occur, therefore, make sure to keep the heat exchanger water flow or water thoroughly, put a clean.

9. PCB Photo and Address Code Setting

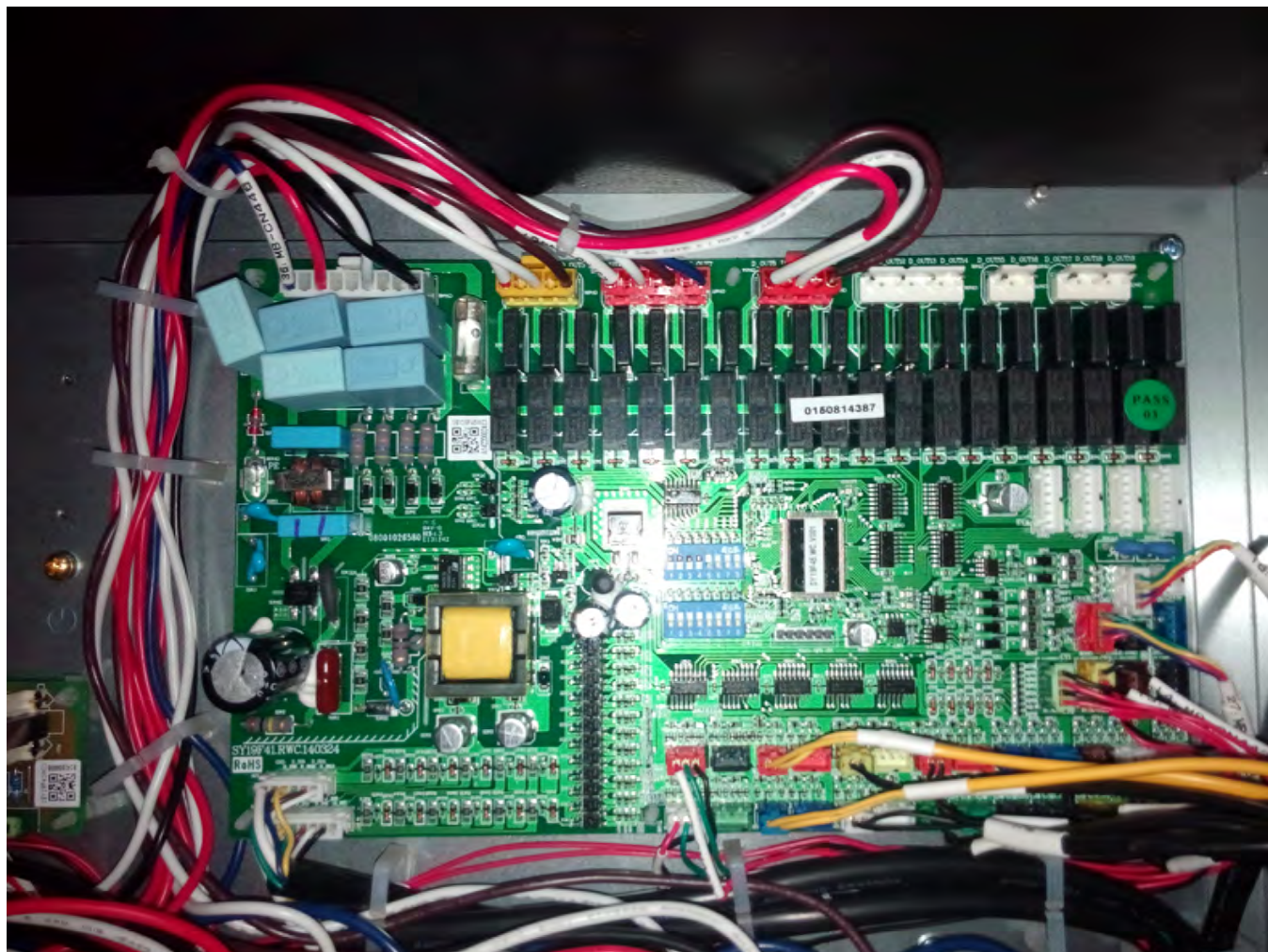

Address Code Setting

The former four digits of the eight-digit code switch are for module address setting, and the latter four for unit mode and capacity setting. The unit mode and capacity codes have been set in delivery, and they are unchangeable. The unit address codes default to ON, ON, ON and ON (for master unit), and in delivery, the codes default to ON, ON, ON and ON.

The former four digits are available for module address:

Address No.	SW1	SW2	SW3	SW4
0	ON	ON	ON	ON
1	ON	ON	ON	OFF
2	ON	ON	OFF	ON
3	ON	ON	OFF	OFF
4	ON	OFF	ON	ON
5	ON	OFF	ON	OFF
6	ON	OFF	OFF	ON
7	ON	OFF	OFF	OFF
8	OFF	ON	ON	ON
9	OFF	ON	ON	OFF
10	OFF	ON	OFF	ON
11	OFF	ON	OFF	OFF
12	OFF	OFF	ON	ON
13	OFF	OFF	ON	OFF
14	OFF	OFF	OFF	ON
15	OFF	OFF	OFF	OFF

Note:

- (1) There is no same address code in one system.
- (2) The above address codes must be set by professionals.

10. Fault Code

S/N	Fault code	Fault description	Remarks
1	E01	Fault in flow switch	
2	E05	Three-phase AC input phase failure protection	
3	E06	Three-phase AC input phase sequence protection	
4	E07	Fault in return water temperature sensor	
5	E08	Fault in water outlet temperature sensor	
6	E09	Fault in outdoor ambient temperature sensor	
7	E16	Fault in communication of wired controller	
8	E20	Fault in overload protection of System A fan	
9	E21	Fault in overload protection of System B fan	
10	E22	High-pressure protection of System A	
11	E24	Over-current protection of System A compressor	
12	E25	Open circuit or short circuit in exhaust temperature sensor of System A compressor	
13	E26	Open circuit or short circuit in coil (outlet) temperature sensor 1 of System A	
14	E27	Open circuit in low-pressure sensor of System A	
15	E28	Low pressure protection of System A	
16	E29	Open circuit or short circuit in suction temperature sensor of System A	
17	E31	Overtemperature of exhaust temperature sensor of System A compressor	
18	E32	Overtemperature of coil (outlet) temperature sensor 1 of System A	
19	E33	Open circuit or short circuit in coil (outlet) temperature sensor 2 of System A	
20	E34	Open circuit or short circuit in coil (outlet) temperature sensor 2 of System B	
21	E38	Refrigerant lack protection of System C	
22	E39	Refrigerant lack protection of System D	
23	E40	Overtemperature of suction temperature sensor of System C compressor	
24	E41	Overtemperature of suction temperature sensor of System D compressor	
25	E43	Open circuit or short circuit in coil (outlet) temperature sensor 2 of System C	
26	E44	Open circuit or short circuit in coil (outlet) temperature sensor 2 of System D	
27	E45	Fault in overload protection of System C fan	
28	E46	Fault in overload protection of System D fan	
29	E52	High-pressure protection of System B	
30	E54	Over-current protection of compressor of System B	
31	E55	Open circuit or short circuit in exhaust temperature sensor of System B compressor	
32	E56	Open circuit or short circuit in coil (outlet) temperature sensor 1 of System B	
33	E57	Open circuit in low-pressure sensor of System B	
34	E58	Low pressure protection of System B	
35	E59	Open circuit or short circuit in suction temperature sensor of System B	
36	E61	Overtemperature of exhaust temperature sensor of System B compressor	
37	E62	Overtemperature of coil (outlet) temperature sensor 1 of System B	
38	E63	Overload protection of System pump	
39	E64	Overload protection of System electrical assisted heater	
40	E67	Overtop or low protection of outdoor ambient temperature	
41	E68	Refrigerant lack protection of System A	
42	E69	Refrigerant lack protection of System B	

S/N	Fault code	Fault description	Remarks
43	E70	Overtemperature of suction temperature sensor of System A compressor	
44	E71	Overtemperature of suction temperature sensor of System B compressor	
45	E72	Overtop Temperature difference of in and out water	
46	E74	Over-current protection of System C compressor	
47	E75	Open circuit or short circuit in exhaust temperature sensor of System C compressor	
48	E76	Open circuit or short circuit in coil (outlet) temperature sensor 1 of System C	
49	E77	Open circuit in low-pressure sensor of System C	
50	E78	Low pressure protection of System C	
51	E79	Open circuit or short circuit in suction temperature sensor of System C	
52	E80	Running time exceeded	
53	E81	Overtemperature of exhaust temperature sensor of System C compressor	
54	E82	Overtemperature of coil (outlet) temperature sensor 1 of System C	
55	E83	High-pressure protection of System C	
56	E87	High-pressure protection of System D	
57	E89	Over-current protection of System D compressor	
58	E90	Open circuit or short circuit in exhaust temperature sensor of System D compressor	
59	E91	Open circuit or short circuit in coil (outlet) temperature sensor 1 of System D	
60	E92	Open circuit in low-pressure sensor of System D	
61	E93	Low pressure protection of System D	
62	E94	Open circuit or short circuit in suction temperature sensor of System D	
63	E96	Overtemperature of exhaust temperature sensor of System D compressor	
64	E97	Overtemperature of coil (outlet) temperature sensor 1 of System D	

Note:

E22,, E24, E28, E31, E52, E54, E58 and E61 are severe protection faults. If such faults are repeated three times within 60 min, the corresponding systems fail to automatic recovery, and they must be recovered after troubleshooting in power failure.

Note:

1. *If the master unit malfunctions, the master unit stops, without impact on other units (except for flow switch fault).*
2. *If the slave unit malfunctions, only this unit stops, without impact on other units.*

11. Trouble Shooting

S/N	Fault description	Possible cause	Troubleshooting	Remark
1	Too high exhaust pressure	1. Air or non-condensable gas found in the system	Discharge and empty, if necessary, the non-condensable gas	Cooling/heating
		2. High suction pressure	Refer to "High Suction Pressure"	Cooling/heating
		3. Undesirable high-pressure switch	Replace the high-pressure switch	Cooling/heating
		4. Dirty or clogged fin of the condenser	Clean the air-side heat exchanger	Cooling
		5. Insufficient air capacity or faulty fan of the condenser	Check the fan	Cooling
		6. High charge of refrigerant	Adjust the charge of refrigerant	Cooling
		7. High ambient temperature	Inspect the ambient temperature	Cooling
		8. Insufficient water flow	Check the water flow	Heating
		9. Water-side heat exchanger scaling or with foreign matters inside	Clean up the incrustation scale	Heating
		10. High outlet temperature of water-side heat exchanger	Check the water temperature	Heating
2	Low suction pressure	1. Insufficient refrigerant	Adjust the charge of refrigerant	Cooling/heating
		2. Undesirable low-pressure switch	Replace the low-pressure switch	Cooling/heating
		3. Insufficient water flow	Check the water flow	Cooling
		4. Low water inlet temperature at water side	Check the water temperature	Cooling
		5. Water-side heat exchanger scaling or with foreign matters inside	Clean up the incrustation scale	Cooling
		6. Insufficient air capacity	Check the fan	Heating
		7. Short circuit found in air circuit	Check the cause of short circuit and take troubleshooting	Heating
		8. Incomplete defrosting	Replace the poor 4-way valve or defrosting sensor	Heating
3	Too low exhaust pressure	1. Lack of refrigerant	Adjust the charge of refrigerant	Cooling/heating
		2. Low suction pressure	Refer to "Low Suction Pressure"	Cooling/heating
		3. Low ambient temperature of air-side heat exchanger	Check the ambient temperature	Cooling
		4. Too low water temperature at water side	Check the water temperature	Heating
4	High suction pressure	1. Too high charge of refrigerant	Adjust the charge of refrigerant	Cooling/heating
		2. High water inlet temperature at water side	Check the water temperature	Cooling
		3. High ambient temperature of air-side heat exchanger	Check the ambient temperature	Heating

S/N	Fault description	Possible cause	Troubleshooting	Remark
5	Overtemperature of exhaust temperature sensor	1. Poor ventilation around the unit	Clean up the obstacles around the unit, or add air ducts	Heating
		2. Too low ambient temperature	Shut down	Heating
		3. Dirty or clogged filter at fluorine side	Replace the filter	Cooling/heating
		4. Incomplete frosting (for heating) or no frosting	Change the frosting parameters	Heating
6	Open circuit or short circuit of temperature sensor	1. Damaged sensor	Replace the sensor	Cooling/heating
		2. Poor connection of sensor	Reconnect the sensor	
7	Abnormal noise	1. Loose metal plate bolts	Tighten bolts	Cooling/heating
		2. Liquid impact due to entry of liquid refrigerant into the compressor	Adjust the charge of refrigerant or the poor throttling device	
		3. Poor compressor	Replace the compressor	
8	Fault in flow switch	1. Air found in the water system	Discharge and empty, if necessary, the non-condensable gas	Cooling/heating
		2. Water-side heat exchanger scaling or with foreign matters inside	Refer to "High Suction Pressure"	
		3. Poor switch	Replace the high-pressure switch	
		4. Unevenly distributed flow in water pipelines	Clean the air-side heat exchanger	
		5. Out-of-service water pump	Check the fan	
		6. Insufficient types of water pumps	Adjust the charge of refrigerant	
9	Fault in communication of wired controller	1. Incorrect unit numbering	Check the unit numbering, and correct it.	Cooling/heating
		2. Incorrect connection of communication wires	Check the order of connection of communication wires	
		3. Damaged PCB	Replace the PCB	
		4. Poor wired controller	Replace the wired controller	
10	Over-current fault of compressor	1. High exhaust pressure and high suction pressure	Refer to "High Exhaust Pressure" and "High Suction Pressure"	Cooling/heating
		2. High or low voltage, single phase or phase imbalance	Check the power supply	
		3. Short circuit in motor or terminal	Check the terminal connections	
11	Open circuit in low-pressure sensor	1. Damaged sensor	Replace the sensor	Cooling/heating
		2. Poor connection of sensor	Reconnect the sensor	

12. Unit Operating Range and Service Condition

■ Unit Service Conditions

1. Unit operating range

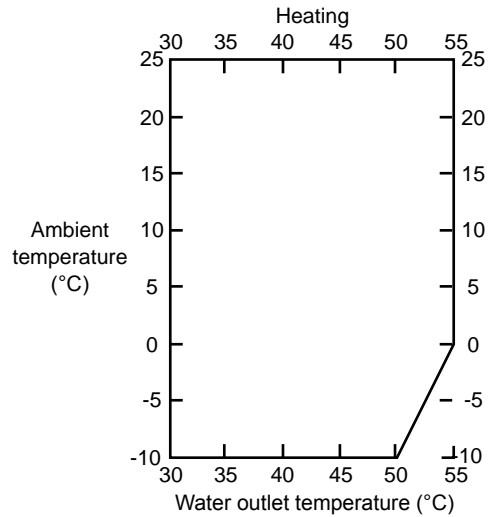
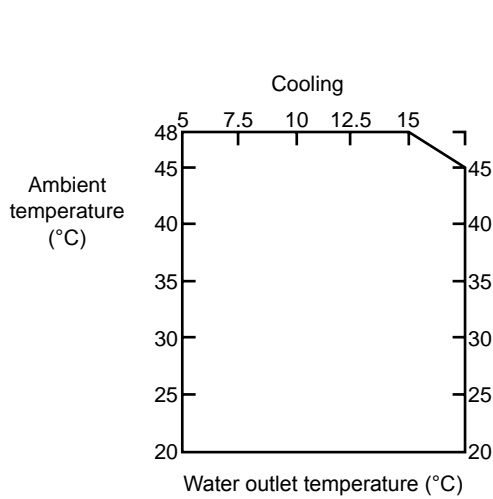

2. Service conditions

Item	Contents
Power supply voltage	Within $\pm 10\%$ of the rated voltage
Power supply frequency	Within $\pm 1\%$ of rated frequency
Phase imbalance	Voltage difference between two phases of the power supply is less than 2% of the rated voltage
Chilled water flow	Within $\pm 30\%$ of the rated water flow
Chilled water pressure	Below 0.7MPa
Chilled water quality	Free from corrosive copper, iron, dissolved matters of welding materials
Installation site	Provided with snow protection and ventilation
Ambient temperature	Refer to the above diagram (operating range).
Relative humidity	Below 90%
Optimal operating temperature	12°C for cooling, 40°C for heating

Note:

the operating range based on GB/T 18430.1, and the rated water flow is obtained from lab. If the unit exceeds the maximum operating range, it only can run for a short time, otherwise the unit may send fault alarm or be damaged.

13. Technical Parameters

■ Correction factor

Cooling:

Water outlet temperature (°C)	Ambient temperature (°C)				
	25	30	35	40	45
kW	Cooling capacity	Cooling capacity	Cooling capacity	Cooling capacity	Cooling capacity
5	1.07	1.00	0.94	0.94	0.81
7	1.14	1.07	1.00	0.96	0.86
9	1.20	2.13	1.06	0.98	0.91
11	1.27	1.19	1.12	1.04	0.96
13	1.34	1.26	1.17	1.09	1.01
15	1.41	1.32	1.23	1.14	1.06

Heating

Water outlet temperature (°C)	Ambient temperature (°C)							
	15	10	7	5	0	-5	-10	-15
kW	Heating capacity	Heating capacity	Heating capacity	Heating capacity	Heating capacity	Heating capacity	Heating capacity	Heating capacity
30	1.26	1.16	1.12	1.07	0.88	0.82	0.72	0.69
35	1.24	1.15	1.11	1.06	0.88	0.81	0.71	0.69
40	1.22	1.14	1.10	1.05	0.87	0.80	0.71	0.67
45	1.19	1.12	1.00	1.03	0.85	0.79	0.70	0.66
50	1.19	1.11	1.07	1.02	0.84	0.78	0.67	0.65
55	1.14	1.07	1.03	0.98	0.83	0.77	-	-



Haier Commercial Air Condition

ADDRESS: No.1 Haier Road, Hi-tech Zone, Qingdao 266101 P.R.China

Web: [Http://www.haier.com](http://www.haier.com)