

Fisher & Paykel

Active Smart™ refrigerator

Ice & Water and Non-Ice & Water models
E402B, E411T, E440T, E442B, E521T,
E522B & RF540A models

**Installation instructions
and User guide**

Introduction	2
Safety and warnings	3
Installation instructions (all models)	5
Installation instructions (Ice & Water only)	8
Installation instructions (all models)	12
Non Ice & Water display	16
Ice & Water display	18
Bottle Chill and Fast Freeze	20
The temperature of your refrigerator and freezer	21
Settings	21
User warnings	22
Using your water dispenser (Ice & Water models only)	23
Water filter (Ice & Water models only)	24
Using your ice maker (Ice & Water models only)	26
Active Smart™ special features (all models)	28
Cleaning and caring for your refrigerator (all models)	31
Refrigerator sounds (all models)	35
Storing food in your refrigerator (all models)	36
Storing food in your freezer (all models)	38
Troubleshooting (all models)	40
Troubleshooting (Ice & Water models only)	42
Customer Care	44
European directive 2002/96/EC on Waste Electrical and Electronic Equipment (WEEE)	45
Filter performance data sheet	46

Important!

SAVE THESE INSTRUCTIONS

This User Guide is to be used for all refrigerator/freezers. It contains all the general information required for the operation of your refrigerator/freezer.

The models shown in this User Guide may not be available in all markets and are subject to change at any time. For current details about model and specification availability in your country, please visit our local website listed on the back cover or contact your local Fisher & Paykel dealer.

Note that the word “refrigerator”, throughout this User Guide, refers to combination refrigerator/freezer products.

2 Introduction

Thank you for buying a Fisher & Paykel *Active Smart*™ refrigerator. Thousands of hours of food care research and 75 years of refrigeration experience has been programmed into your refrigerator to give you the best possible performance.

With the Ice & Water models we have achieved water dispensing through the door without compromising storage space or access in the refrigerator. The automatic ice maker means ice is always on hand, ready for your use.

We hope you enjoy your new refrigerator.

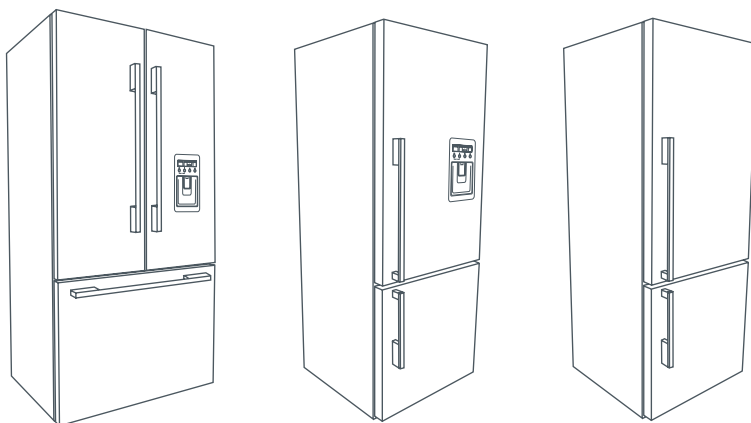

Fig.1 Active Smart™ refrigerators

Important!

It is important that this User Guide is retained with your Active Smart™ refrigerator for future reference. Should the appliance be sold or transferred to another owner, please ensure that the User Guide is left with the appliance. This will ensure that the new owner can familiarise themselves with the information and warnings contained within the Guide.

⚠ WARNING!**Electric Shock Hazard**

Read and follow the SAFETY AND WARNINGS outlined in this User Guide before operating this appliance.

Failure to do so can result in death, electric shock, fire or injury to persons.

Use this appliance only for its intended purpose as described in this User Guide.

Important!

When using this appliance always exercise basic safety precautions including the following:

Danger

- *This appliance is not intended for use by persons (including children) with reduced physical, sensory or mental capabilities, or lack of experience and knowledge, unless they have been given supervision or instruction concerning use of the appliance by a person responsible for their safety.*
- *Young children should be supervised to ensure they do not play with the appliance.*
- *Risk of child entrapment. Before you throw away your old refrigerator or freezer:*
 - *Take off the doors*
 - *Leave the shelves in place so that children may not easily climb inside.*
- *The manufacturer's installation instructions for product and cabinetry ventilation must be followed when installing the appliance.*
- *Keep ventilation openings, in the appliance enclosure or in the built-in structure, clear of obstruction.*
- *Do not use mechanical devices or other means to accelerate the defrosting process, other than those recommended by the manufacturer.*
- *Do not damage the refrigerant circuit.*

Disposal

- *Extreme care must be taken when disposing of your old appliance to avoid hazards. The refrigerant gas must be safely removed and for the safety of young children, remove doors.*
- *Your Fisher & Paykel Appliances Authorised Service Centre will be able to give advice on environmentally friendly methods of disposing of your old refrigerator or freezer.*

Electrical

- *This appliance must be properly installed in accordance with the installation instructions before it is used.*
- *Never unplug your refrigerator by pulling on the power cord.*
- *Always grip the plug firmly and pull straight out from the outlet.*
- *Do not plug in any other appliance at the same power point as your refrigerator or use extension cords or double adapters.*
- *Repair or replace immediately all electric service cords that have become frayed or otherwise damaged. Do not use a cord that shows cracks or abrasion along its length or at either the plug or appliance end.*

Safety and warnings

- *If the power supply cord is damaged, it must only be replaced by your Fisher & Paykel Appliances Authorised Service Centre because special purpose tools are required.*
- *When moving your appliance away from the wall, be careful not to roll over or damage the power cord.*
- *Unplug your refrigerator before cleaning or replacing the lightbulb.*
- *Do not use electrical appliances inside the food storage compartments of the appliance, unless they are of the type recommended by the manufacturer.*

Important!

Your refrigerator is designed to operate for many years without the need for service checks. However, if your refrigerator is malfunctioning, have it attended to by your Fisher & Paykel Appliances Authorised Service Centre as soon as possible. All electrical repairs must be carried out by an adequately trained service technician or qualified electrician.

Storing food and drinks

- *DO NOT store explosive substances such as aerosol cans with a flammable propellant in this appliance.*
- *Never store volatile or flammable materials in your refrigerator as they may explode.*
- *Never freeze liquids in glass containers. Liquid expands during freezing, which may cause the container to explode.*
- *Never freeze carbonated drinks. They may explode.*
- *Do not consume food if it is too cold. Food removed from the freezer compartment may be cold enough to cause damage when brought into contact with bare skin, eg frozen ice cubes.*

Power failure – food safety

- *Do not refreeze frozen foods that have thawed completely. Follow the recommendations below if you discover food in your freezer has thawed:*
 - 1) *Ice crystals still visible – food may be refrozen but should be stored for a shorter period than recommended.*
 - 2) *Thawed but refrigerator cold – refreezing generally not recommended. Fruits and some cooked food can be refrozen but use as soon as possible. Meat, fish, poultry – use immediately or cook then refreeze. Vegetables – discard as they usually go limp and soggy.*
 - 3) *Thawed and warmer than 5°C (41°F) – discard all food.*
- *Do not refreeze frozen foods that have thawed completely. The food may be dangerous to eat.*

Important!

Cleaning

- *Many commercially available cleaning products contain solvents which may attack plastic components of your refrigerator and cause them to crack. Please refer to the cleaning care section of this booklet for further advice.*

SAVE THESE INSTRUCTIONS

⚠ WARNING!



Electric Shock Hazard

Read and follow the **SAFETY AND WARNINGS** outlined in this User Guide before operating this appliance, pages 3 – 4.

Failure to do so can result in death, electric shock, fire or injury to persons.

Please follow the installation steps below to ensure your appliance operates correctly.

1. Power

- The appliance must be installed so the plug is accessible.
- To ensure that the appliance is not accidentally switched off, connect your refrigerator to its own power point. Do not plug in any other appliance at this power point or use extension cords and double adaptors, as the combined weight of both power cords can pull the double adaptor from a wall outlet socket.
- For power requirements, refer to the information on the serial plate located at the front bottom right-hand side of the refrigerator when the door is open.
- It is essential that the appliance be properly grounded (earthed).

2. Location

- Your refrigerator should not be located in direct sunlight or next to any heat generating appliance such as a cooktop, oven or dishwasher.

6 Installation instructions (all models)

E402B, E411T, E440T, E442B, E521T, E522B

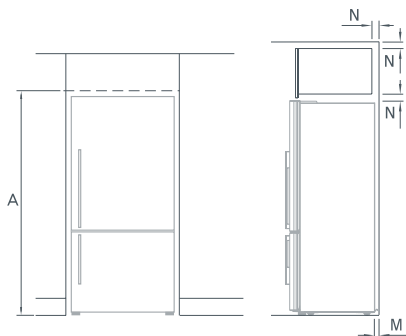

Flush with refrigerator chassis – full door rotation

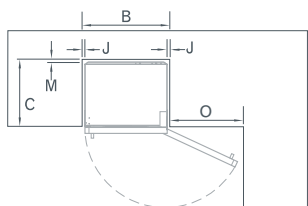

Flush with refrigerator door – full door rotation

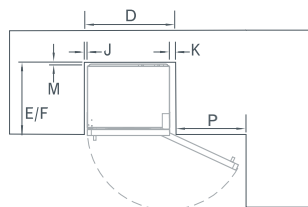

Flush with refrigerator door – 90° door rotation

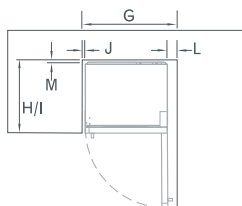

RF540A

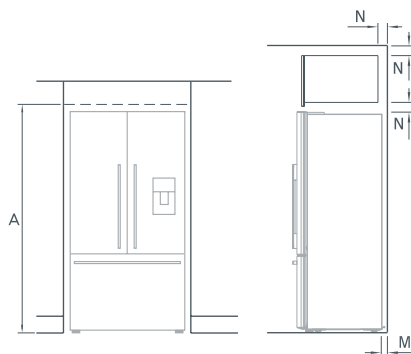

Flush with refrigerator chassis – full door rotation

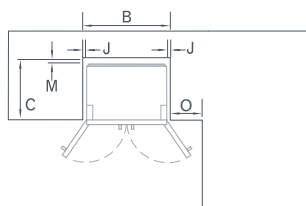

Flush with refrigerator door – full door rotation

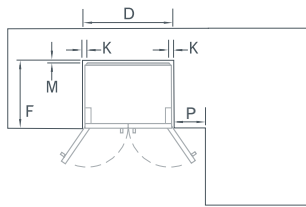

Flush with refrigerator door – 90° door rotation

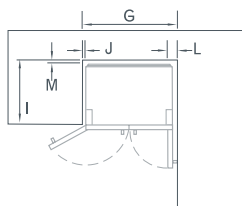

3. Ventilation and installation

- To ensure adequate ventilation for your refrigerator see recommended cabinetry dimensions below.
- These measurements do not include space for the water filter, (only required on Ice & Water cabinets), at the back of the cabinet as we recommend that the filter is placed as close to the incoming water supply as possible.
- If integrating your refrigerator, follow installation instructions provided with integration kit.

Cabinetry dimensions (mm) (including minimum air clearances)	E402B E411T	E440T E442B	E521T E522B	RF540A
A inside height	1735	1735	1735	1810
Flush with refrigerator chassis – full door rotation				
B inside width	675	720	830	940
C inside depth	620	620	620	620
Flush with refrigerator door – full door rotation				
D inside width	705	750	860	1000
E inside depth flush to curved door	675	675	675	–
F inside depth flush to flat door	690	690	690	690
Flush with refrigerator door – 90° door rotation (for full drawer/shelf access, the doors need to be open past 90°)				
G inside width	745	790	900	1010
H inside depth flush to curved door	675	675	675	–
I inside depth flush to flat door	690	690	690	690
Minimum clearances				
J side clearance	20	20	20	20
K side clearance – hinge side flush with door – full rotation	50	50	50	50
L side clearance – hinge side flush with door – 90° rotation	90	90	90	90
M rear clearance (incl. evaporator tray)	30	30	30	30
N vent (above refrigerator cabinet or around top of cupboard)	50	50	50	50
O door clearance – hinge side flush with chassis – full rotation	520	555	645	365
P door clearance – hinge side flush door – full rotation	490	525	615	335

Contents of filter kit

- 1 4 m (13 ft) white 6 mm (¼") tubing
- 2 1 x 200 mm (8") blue tubing
- 3 1 x pressure reducing valve (PRV)
- 4 1 x double sided foam
- 5 2 x locking keys
- 6 1 x water filter cartridge and head (where fitted)
- 7 1 x tap connection – 15 mm (½") BSP

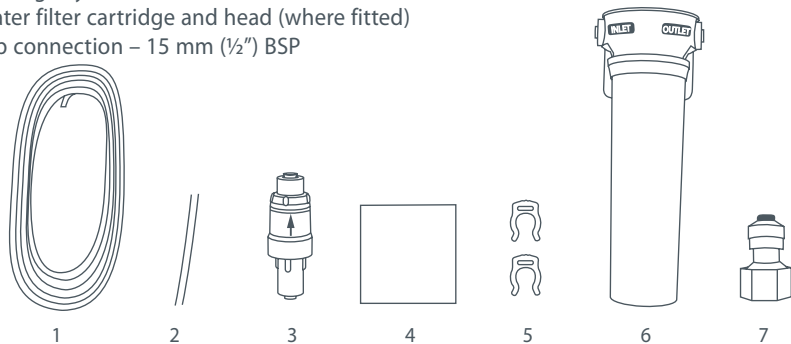

Fig.2 Water connection kit

Important!

- *It is imperative the pressure reducing valve (PRV) is fitted prior to the filter. This valve ensures water will not flow back into the mains from the refrigerator's water system. If the PRV is not fitted to the connection line, the Ice & Water features may not function in some circumstances.*
- *The water connection to your Ice & Water refrigerator must be installed by an authorised plumber or authorised Fisher & Paykel service person.*
- *The water connection instructions below are intended only for the professional installer.*
- *The new tubings supplied with the machine are to be used, old tubings should not be used.*

Installation precautions/warning

- **DO NOT use with water that is microbiologically unsafe or of unknown quality without adequate disinfection before or after the system.**
- **WARNING – connect to potable water supply only.**
- **DO NOT install on line pressure above 827 kPa (119 psi) or below 150 kPa (22 psi).**
- **DO NOT use on hot water supply (38°C [100°F max.]).**
- **DO NOT cut any length of tube shorter than 200 mm.**
- **DO NOT install near electrical wires or water pipes that will be in the path of drilling when selecting the location of the filter system.**
- **DO NOT mount the filter in such a position that it will be struck by other items, such as wastebaskets, etc.**
- **DO NOT install the filter or any water tubing in direct sunlight as prolonged exposure to light can weaken plastic components.**
- **DO NOT install the filter in a location that is susceptible to freezing temperatures as damage to the filter housing could occur.**
- **DO NOT screw the filter to the refrigerator.**
- **DO NOT install the filter or any water tubing in high temperature areas eg in a ceiling cavity.**
- **AVOID contamination of pipes during installation.**
- **DO NOT use copper tubing. The plastic tubing supplied should always be used.**
- **DO NOT continuously dispense water for a period longer than 2 minutes.**

Installation instructions:

- 1 Ensure the refrigerator is not plugged into a power supply.
- 2 Locate isolation tap for water connection – cold water feed only (dishwasher or sink mixer taps). Tee and tap fitting is not supplied.
- 3 Connect the 200 mm (8") blue tubing to the outlet of the PRV (blue collet) and the inlet connection of the water filter cartridge as shown in Diagram 1. Gently pull on both ends to ensure it is locked.
- 4 Connect the white 6 mm (¼") tubing to the outlet of the water filter cartridge as shown in Diagram 2. Gently pull to ensure it is locked.
- 5 Measure the required length of tubing to run from the PRV to the water connection point.
- 6 Cut the tubing making sure the ends are square and clean.
- 7 Connect the tubing to the tap connection and the base of the PRV (white collet) and then to the tap as shown in Diagram 3. Please note that the tap connection supplied should fit most installation situations.
- 8 Connect one locking key to each side of the water filter cartridge in between the cartridge and the locking collet as shown in Diagram 4.
- 9 To flush the water filter of any trapped air, harmless carbon fines and to also check for leaks, aim the end of the tubing into a bucket, turn isolating tap on and run at least 10 litres (10 qt) of water through. Once complete, turn isolating tap off.
- 10 Locate desired position for water filter noting carefully the following points:
 - It is recommended to fit the water filter in a vertical orientation with the water filter head at the top. This will minimise water leakage when replacing cartridge.
 - Ensure the filter is in a convenient location to access every 6 months for replacement. We suggest that this location is beside the water filter supply tap in the cupboard beside the refrigerator.
 - A minimum clearance of 64 mm (2 ½") from the bottom of the filter cartridge is required to perform cartridge removal.
 - Do not screw water filter to the refrigerator.

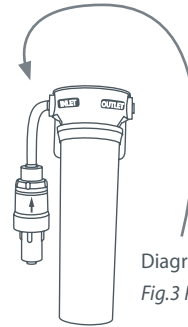

Diagram 1
Fig.3 PRV connection

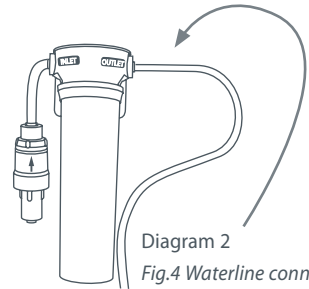

Diagram 2
Fig.4 Waterline connection

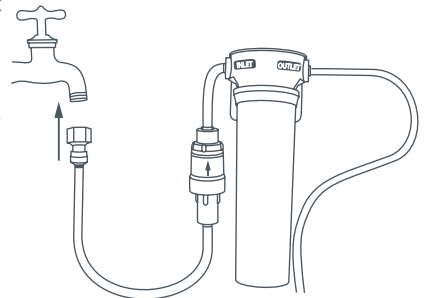

Diagram 3
Fig.5 Tap connection

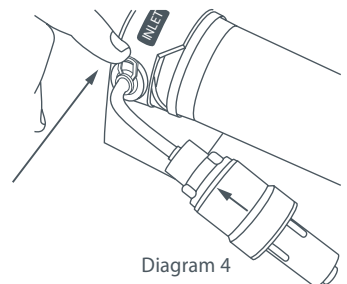

Diagram 4
Fig.6 Locking key

- 11 Attach double sided foam to the back of the water filter head as shown in Diagram 5. Write the date to be replaced on the filter (date installed + 6 months). Remove double sided foam backing and attach filter to the desired position as located in step 10 (refer to previous page).
- 12 Run the 6 mm (¼") tubing to the back of the refrigerator ensuring there is enough tubing to pull out the refrigerator for service.
- 13 Connect tubing into the water (solenoid) valve located on the right hand side of the unit (compressor) compartment as shown in Diagram 7. Beware of hot pipes.
- 14 Pull gently on tubing to ensure it is locked in as shown in Diagram 8.
- 15 The completed installation should look like Diagram 9 on page 11.

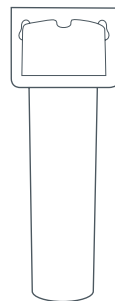

Diagram 5

Fig.7 Double sided foam attachment

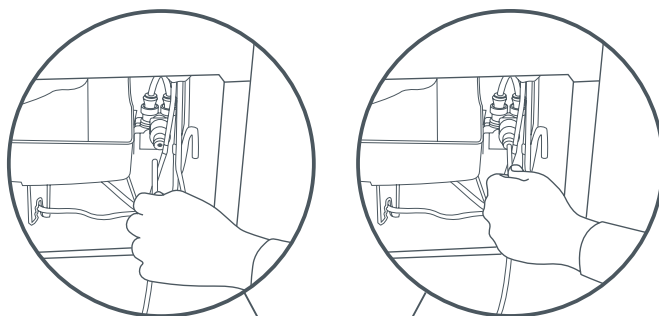

Diagram 7

Diagram 8

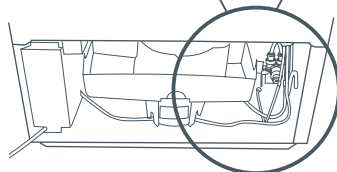





Diagram 6

Fig.8 Waterline connection to refrigerator

- 16 Turn isolating tap on and check that all connections are dry and free of drips.
- 17 Coil water line tubing behind the refrigerator. Push your refrigerator into place being careful not to kink or squash the water line running into the water (solenoid) valve.
- 18 Read pages 12 – 15 carefully, and then turn the refrigerator on.
- 19 The first time you require water out of the dispenser, there will be a delay while the water reservoir fills up.
- 20 Run a further 3 litres (3 qt) through the system, stopping intermittently to ensure the reservoir is flushed out. Failure to do this will result in excessive dripping from your dispenser.
- 21 On your display press the  button until the Ice menu is highlighted. Then press  to turn on the ice maker. Press and hold   together to force a cycle. The ice tray will flip. Force another cycle. The ice tray will flip and spill water into the ice bin. Empty water and replace bin.
- 22 You are now ready to enjoy automatic ice dispensing and chilled water from your Active Smart™ refrigerator. Please note that once installation is complete, a few drips may appear out of the dispenser over the next few days as the remaining trapped air is cleared.

Important!

- *All connections must be checked for leaks.*
- *Ensure white 6 mm (¼") tubing is routed away from sharp objects, sharp corners (beware of kinking tube as this will stop water flow), clear of the refrigerator unit compartment and not in a location where it can be squashed.*
- *Ensure all push-fit connections are firmly pushed into place. The tube should push in 20 mm (¾") before reaching the stop.*
- *If tubing is removed at any point, re-cut the end and re-insert. Tubing must be fully inserted to avoid leaks.*
- *To remove tube from connection points, turn off the isolating tap, push in the collet and gently pull tubing at the same time.*

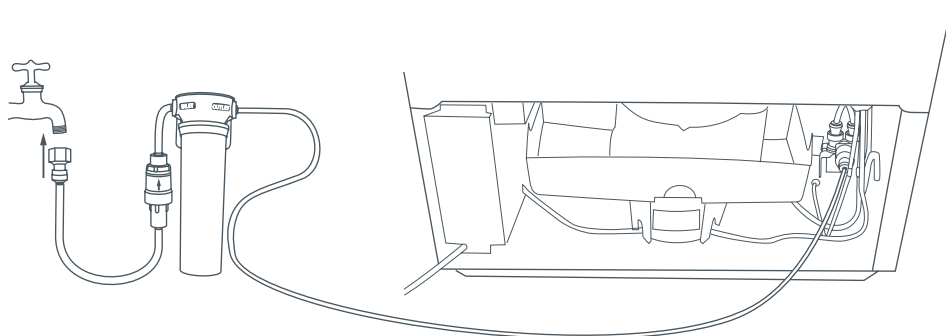

Diagram 9

Fig.9 Connection to water supply

System tested and certified by NSF International against NSF/ANSI Standard 53 for the reduction of Asbestos, Atrazine, Benzene, Cyst, Carbofuran, Lead, Lindane, Mercury, P-Dichlorobenzene, Toxaphene & Turbidity; against Standard NSF/ANSI 42 for the reduction of Chlorine Taste and Odour and Nominal Particulate Class I to a capacity of 2,838 Litres (750 gallons).

4. Installation

Your Fisher & Paykel *Active Smart™* refrigerator is fitted with front and rear rollers, designed for moving the product in the forwards and backwards direction.

Avoid moving the product in a sideways direction as this may damage the rollers or the floor covering/surface.

- A** Your refrigerator will arrive with the front feet wound up making moving the product into its final location a simple task.
- B** Roll the refrigerator into its final position making sure there is the correct air gap between the product and surrounding cabinetry. See minimum clearance in cabinetry dimensions table (refer to page 7).
- (RF540A model only)**
- C** Adjust the front feet down until the refrigerator is leaning backward with the front approximately 10 mm higher than the back. This will ensure a good door closing action. (Refer to Fig.10).
- D** Aligning your refrigerator with cabinetry.
- Align the sides of the refrigerator with the cabinetry by adjusting the hinge side front foot.
 - Adjust the handle side foot until it touches the floor and takes a small amount of weight.
 - Once the refrigerator is in place and aligned with cupboards/alcove push gently on the front top and check if the product is rocking or stable.

5. Levelling of refrigerator door (RF540A model only)

- For uneven surfaces, front feet can be used to align the 2 doors.
- If left hand door is too low, then unscrew the left hand foot to lift up the cabinet until the two doors top edges are aligned.
- If right hand door is higher, then adjust the right hand foot in the same way.

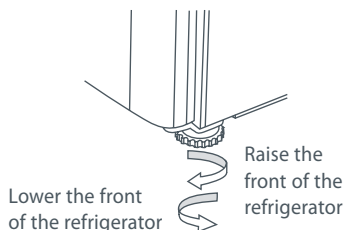

Fig.10 Refrigerator feet

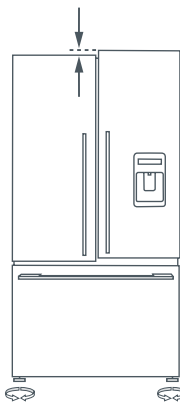

Fig.11 Uneven door alignment

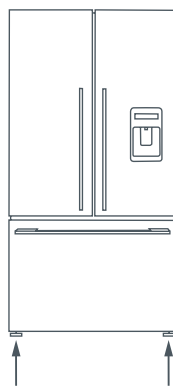

Fig.12 Even door alignment

6. What to do if your product is unstable

- E** Gently push the refrigerator back until the rear rollers contact the floor.
- Measure the gap under the front foot, which has come off the floor.
 - Obtain some solid packing material (hardwood, plastic, etc) which fits firmly into the gap under the foot.

Note: do not use metallic materials that may corrode, stain and/or damage floor coverings.

- F** Wind both front feet up and roll the product out of position.
- Place the packing material in the location diagonally opposite the front roller that lifts off the floor.
 - Make sure the packing material stays in place when the product is pushed back into position.
 - Ideally, the packing material is large enough to rest against the back wall so as to prevent it moving when the cabinet is pushed into position.

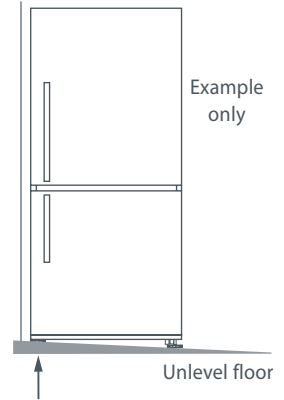

This foot lifts off the floor when top front is gently pushed back

Fig.13 Unstable refrigerator

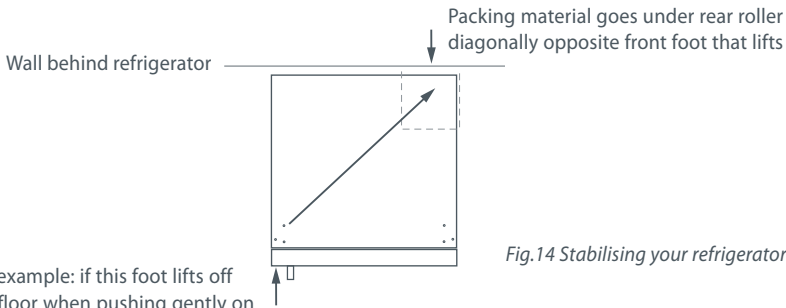

Fig.14 Stabilising your refrigerator

- G** Roll the refrigerator back into position and adjust front feet as per step **D**. (Check alignment and door closing action are satisfactory).
- Make small adjustments to front feet where necessary.
 - Check that the product is stable (all 4 feet are on the floor). If not return to step **E** and repeat steps **F** and **G**.

Before placing food in the fresh food or freezer compartments

- Remove all packaging. Ensure that all transit clips are removed from the refrigerator. These are small rubber stops located at the back of the shelves.
- Allow the refrigerator to run empty for 2 – 3 hours to allow each compartment to cool to the appropriate temperature.
- Clean the inside of the appliance with a mix of warm water and a little liquid detergent and a soft cloth to remove manufacturing and transportation dust.
- The appliance may have an odour on its initial operation, but this will go when the refrigerator has cooled sufficiently.

Before you start using your Ice & Water refrigerator

- Check your refrigerator is switched on and has cooled for at least 2 hours before use (refer to page 21 – The temperature of your refrigerator and freezer).
- Check that the water filter has been connected and turned on.
- Turn on the ice maker (refer to page 24).
- At first use allow approximately 1 minute from when the dispensing pad is pushed until water is dispensed. This will allow the water tank to fill.
- Run through and discard the first 3 L (3 qt) of water from the dispenser, stopping intermittently (refer to page 26 – First use). Failure to do this will result in excessive dripping from your dispenser.
- Discard the first 3 harvests of ice (8 ice cubes are produced per harvest), refer to page 26 – First use.

You are now ready to enjoy ice and water from your refrigerator.

Please note that once installation is complete a few drips may appear out of the dispenser over the next few days as the remaining trapped air is cleared.

Energy efficiency

For the most energy efficient use of your appliance:

- Ensure your refrigerator has adequate ventilation as recommended in the installation instructions.
- Do not cover your appliance with any material that will prevent air from flowing around the cabinet sides.
- Allow good clearances in front of air ducts within the cabinet for maximum cold air distribution.
- Cool hot foods down before placing them in the appliance.
- Do not overfill the compartments.
- Keep door openings to a minimum.
- Select a temperature setting that isn't too cold.
- Check your door seals for leaks.

Moving or storing your refrigerator

If your refrigerator is turned off for any reason, wait 10 minutes before turning it back on. This will allow the refrigeration system pressures to equalise before restarting.

Moving your refrigerator

- On Ice & Water model refrigerators disconnect the water supply.
- Turn off the appliance and unplug from the power point. Remove all food.
- Turn the adjustable feet to the right as far as they will turn (see page 12).
- Ease the refrigerator out of its position. Tuck the power cord away, tape the shelves in place and tape the doors closed. If the cabinet needs to be placed at an angle or laid down, carefully lay it on its side (the right hand side when viewed from the front).
- Relocate and install. If the appliance has been left on its side for any length of time, leave it standing upright for at least 10 minutes before turning on.

Storing your refrigerator

- When storing your cleaned appliance, leave the doors open. This allows air to circulate and prevents the build up of bacteria and moulds.
- Before using again, clean well using a mixture of warm water and baking soda (add 1 teaspoon of baking soda to each 500 ml of water). Rinse with clean water.

Holiday time

- We recommend you leave your refrigerator operating while you are on holiday.

16 Non Ice & Water display

Models:	635 mm wide	E402B, E411T
	680 mm wide	E440T, E442B
	790 mm wide	E521T, E522B

For information on the operation of the Ice & Water control panel please refer to page 18.

Temperature control

- When the refrigerator is first turned on, the powerful cooling system will automatically cool both the fresh food and freezer compartments to their set temperatures. This will take between 2 – 3 hours.
- The two compartment temperatures are accurately and independently controlled and do not change with the temperature or humidity of the surroundings; whether summer or winter.
- If you wish to alter the temperature of either the fresh food or freezer compartment, this can be easily done by using the control panel located at the back of the fresh food compartment.

Control panel To adjust temperatures

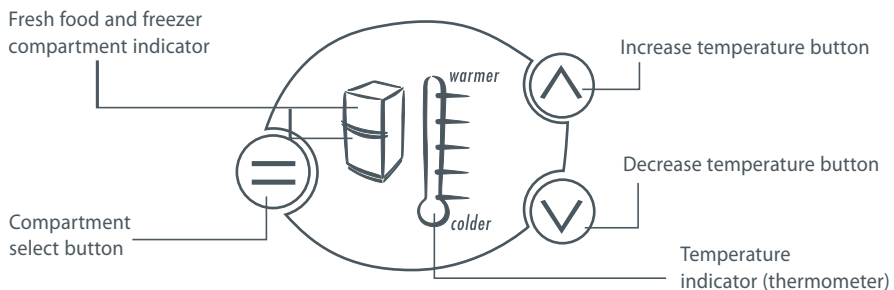

Fig.15 Non Ice & Water control panel

Fresh food compartment

- The fresh food compartment light on the refrigerator diagram will be showing. The temperature indicator illustrated by a thermometer will show the temperature setting for this compartment as a series of lights.
- The temperature may be altered by pressing the \blacktriangle or \blacktriangledown buttons. One press on either of these buttons will produce a dimmer light which indicates a small change in temperature.
- Pressing either button twice gives a brighter light and indicates a greater change in temperature. Fewer lights on the thermometer means a cooler temperature for the compartment selected.

Freezer food compartment

- To adjust the freezer temperature press the **≡** button until the light flashes on the freezer compartment indicator.
- The freezer temperature can be altered by pressing the **∧** or **∨** buttons.
- One press on either of these buttons will produce a dimmer light which indicates a small change in temperature. Pressing either button twice gives a brighter light and indicates a greater change in temperature.
Note: Successively pressing the **≡** button will automatically select between the compartments, a return to the fresh food compartment will be accompanied by a longer beep.
- When the door is reopened the control panel will return automatically to the fresh food compartment setting.

Sabbath mode

- To activate Sabbath mode, open both the fresh food and freezer compartment doors and then hold the **≡** button on the temperature control panel for 10 seconds.
- Both the fresh food and freezer compartment indicators will be illuminated indicating the refrigerator is in Sabbath mode.

When the product is in Sabbath mode:

- The fresh food and freezer compartment indicator lights will be illuminated.
- The light will not operate when the door is opened.
- The door alarm will not operate.
- The display will not function except to indicate Sabbath mode is active as stated above.
- Opening the door will not affect the compressor or fans.
- If the power to the refrigerator is turned off whilst in this mode, the product will continue in Sabbath mode when the power is restored.
- Sabbath mode will automatically de-activate 80 hours after activation.
- To de-activate earlier than 80 hours press the **≡** button on the temperature control panel for 10 seconds.

Fault alarms

- If the electronic controller detects a fault from which it is unable to recover an alarm will sound.
- When the fresh food compartment door is opened a fault code (specific pattern of lights) will flash red and green on the Control panel to alert you to the fault. The audible alarm will stop when any button is pressed but the lights will remain flashing. If such a fault occurs, call your Fisher & Paykel Appliances Authorised Service Centre immediately; the fault code will help the service person find and remedy the cause of failure.

18 Ice & Water display

The display screen enables you to view and modify all the features and options on your refrigerator. For example, you can change the temperature in your fresh food and freezer compartment, and select the Fast Freeze function when you want to quickly freeze meat. You may want to also quickly chill a bottle of wine when friends arrive unexpectedly.

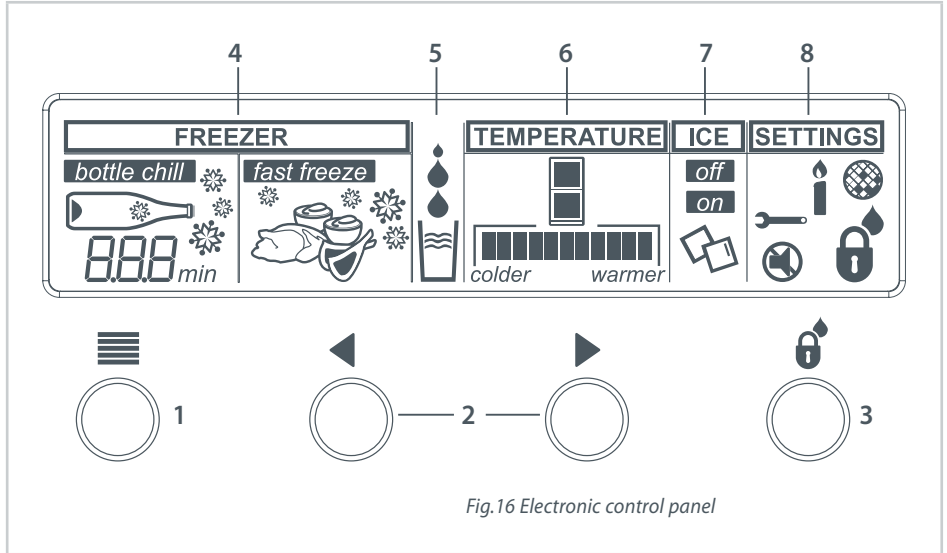

















Fig.16 Electronic control panel

Keys

	<p>1. Main menu – scrolls through the main menu (Freezer, Temperature, Ice and Settings).</p>
	<p>2. Arrow keys – scrolls through the settings of each function.</p>
	<p>3. Key and Dispenser Lock – locks buttons and water dispenser.</p>

Display features

	4. Freezer (page 20)
	Bottle Chill (page 20)
	Fast Freeze (page 20)
	5. Dispensing water (page 23)
	6. Temperature (page 21)
	
	7. Ice (page 26)
	
	8. Settings/User alerts (pages 21 – 22)
	Key Silent Mode (page 21)
	Dispenser and Key Lock (page 21)
	Key Lock – disables the buttons (page 21)
	Sabbath Mode (page 22)
	Filter Reset (page 22)
	Service/Fault Diagnosis (page 22)

20 Ice & Water display















bottle chill



Bottle Chill

This function allows you to chill your beverages more rapidly in the freezer without the worry of forgetting about them. The time taken to chill depends on the size of your beverage. Bottle Chill allows you to customise this chill time.

Recommended times:

- 20 minutes – can or small bottle
 - 25 minutes – wine bottle or similar size beverage
 - 30 minutes – larger bottle
-
- To activate, use the  button until the bottle chill icon () is showing on the  screen. Then use the  or  buttons until the snowflakes () and the minute timer () are displayed on the Bottle Chill screen.
 - Then use the  button to select 10, 15, 20, 25 or 30 minutes as displayed on the Bottle Chill screen. After several seconds, the snowflakes will then animate as the timer counts down.
 - An alarm will sound after the amount of time selected has elapsed.
 - Press any button on the display to silence the alarm. Remember to remove the beverage from the freezer.
 - To deactivate Bottle Chill manually, use the  button to scroll to the bottle chill icon () on the  screen, then use the  and  buttons until no minutes are shown on the screen and the snowflakes () are no longer visible.
 - If you remove your beverage from the freezer and it is not chilled to your liking, reset the timer to 10 minutes and place the beverage back into the freezer.

Important!











Do not leave the bottle inside the freezer longer than the time needed for chilling, as glass bottles may explode.

fast freeze



Fast Freeze





We have created the Fast Freeze feature to help you to get the best possible results when freezing fresh food. Fast Freeze boosts the freezing speed by dropping the freezer to its coldest temperature for 12 hours, which helps to ensure vital freshness, texture and taste are retained during the freezing process.

- To activate, use the  button until the Fast Freeze icon () is showing on the  screen. Then use the  or  buttons until the snowflakes () are displayed on the Fast Freeze screen. The animating snowflakes indicate that Fast Freeze has been activated.
- To deactivate the function manually before the 12 hours are up, use the  button to scroll to the Fast Freeze icon () on the screen. Then use the  and  until there are no snowflakes () present on the screen.

For best results, we recommend that you activate the function approximately 2 hours before it is required. Alternatively, activate it when placing food into the freezer.

Note: the Bottle Chill and Fast Freeze option cannot be used at the same time.

The temperature of your refrigerator and freezer

- When the refrigerator is first turned on it will take approximately 2 to 3 hours to cool.
- To adjust the temperature of a compartment, use the  button to scroll to the **TEMPERATURE** screen, use the  button to select the compartment you want to change.
- The temperature can then be adjusted using the  button to make the compartment warmer or the  button to make the compartment colder.
- The temperature setting will be indicated on the icon below.

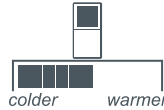





It is important to have your refrigerator set to the correct temperature. Setting it too cold may cause some items in the refrigerator to freeze, and setting it too warm will decrease the storage life of your food.

- For further information on food storage refer to the Food Care section (pages 36 – 39).





Settings

Key Silent Mode

- The Key Silent Mode allows you to silence all key presses.
- It can be activated or deactivated by using the  button to scroll to the **SETTINGS** screen and then pressing the  or  buttons.
- When the Key Silent Mode is on  will appear.
- When this function is off  will appear.

Note: Faults, Bottle Chill timer and the door alarm will still sound when the refrigerator is set on Key Silent Mode.

Dispenser and Key Lock

- The Dispenser Lock disables the buttons and prevents water from being dispensed.
- Key Lock disables the buttons.
- Activate by holding down  on the display panel.
- After 2 seconds  icon will appear indicating Dispenser Lock is activated.
- After 2 more seconds  icon will appear indicating Key Lock is activated.
- To de-activate, hold down  on the display panel for 2 seconds.

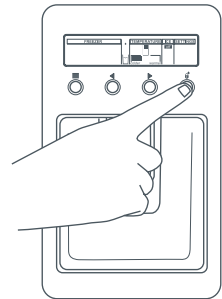





Fig.17 Dispenser and Key Lock



Sabbath Mode

- In Sabbath Mode alarms, lights and displays are deactivated.
- Sabbath Mode can be activated or deactivated by holding down the ,  and  button for 4 seconds.

Once in Sabbath Mode:

- The interior light will not turn on when the refrigerator is opened.
- Door alarms will not operate.
- Display will not be illuminated.
- Electronic control panel will not work, only a small candle icon () will be displayed on the screen.

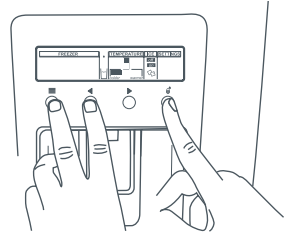

Fig.18 Sabbath Mode

Note: if power is turned off the refrigerator will automatically continue in Sabbath Mode once power is restored. Sabbath Mode will automatically deactivate after 80 hours.

User warnings

Your refrigerator is clever enough to diagnose its own problems. It will alert you when there is a fault.



Filter reset

The filter reset icon () will appear when the water filter needs changing. This will flash when dispensing water. To change the filter and reset the filter icon refer to pages 24 – 25.



Fault

- In the unlikely event a fault occurs the  icon appears on the front of the display and a fault code will be displayed on the left in the **FREEZER** screen.
- When the door is open the refrigerator fault alarm will sound. To silence this press any button on the display.
- Please take note of the fault code and contact our Customer Care Centre. Details of Customer Care can be found in the back of this book.

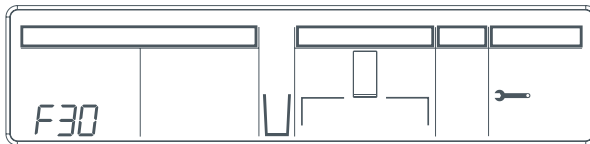



Fig.19 Fault code display



Dispensing

- Your water dispenser has been designed for one-handed operation.
- To dispense water push the dispensing pad gently, using a glass or container. This pad requires only a gentle press to activate.
- When you dispense water, a light will appear above the dispensing area, and on the display screen. The water fill icon  will also appear.
- To stop the flow of water, simply pull your glass away from the dispensing pad.
- Please remember that pressing very hard against the dispensing pad will not make the dispenser operate faster or produce greater quantities of water.

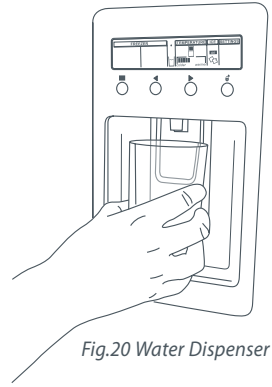

Fig.20 Water Dispenser

First use

- After installation, on the first use, allow approximately a one minute delay while the dispensing pad is pushed until water is dispensed. This will allow the water tank to fill completely.
- After you fill the tank for the first time, dispense and discard approximately 3 litres (3 qt) of water stopping intermittently to flush the tank out.

Important!

To avoid damage to property or personal injury do not put hands, fingers or objects up the dispenser opening.

Please note that once installation is complete a few drips may appear out of the dispenser over the next few days as the remaining trapped air is cleared.

Water filter (Ice & Water models only)

All the water to your refrigerator is filtered to remove impurities through a cartridge located in a position of your choice outside the refrigerator. This will need changing approximately every 6 months.

- There is a replacement indicator icon  on the control panel which will appear when the filter needs replacing. It will flash, as a reminder, when water is dispensed.
- Replacement cartridges are available from your authorised Fisher & Paykel Dealer. The details of the replacement cartridge are on the label on the cartridge.

Changing the water filter cartridge

It is not necessary to turn off the water supply before attempting to change the water filter cartridge.

- 1 Grasp and firmly twist the cartridge in an anticlockwise direction (to the left when installed in the recommended orientation) as shown in Diagram 1.
- 2 Pull the cartridge away from the filter head (down when installed in the recommended orientation) as shown in Diagram 2.
 - It is not unusual for a few drops of water to be present when the filter is removed.
- 3 Discard old filter.
- 4 Filter installation:
 - Remove protective cap on spigot on head.
 - Push the cartridge up towards filter head while rotating it in a clockwise direction (to the right when installed in the recommended orientation) as shown in Diagram 3.
- 5 Reset filter indicator icon on the display (this will remind you when the filter is due to be replaced again). Refer to page 25.
- 6 Dispense 10 litres (10 qt) to flush the cartridge, removing trapped air and harmless carbon fines.
- 7 A few drips may appear out of the dispenser over the next few days as the remaining trapped air is cleared.

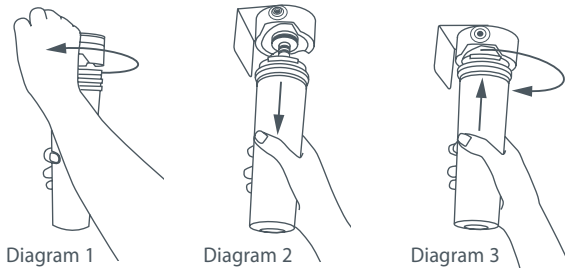



Fig.21 Changing the water filter cartridge

To reset filter indicator



Important!

We recommend the water filter is used from installation.

Do not reset indicator before filter is changed or filter monitoring will be inaccurate.

- Press and hold ► and  buttons for 4 seconds.
- If the filter is present the  icon in the **SETTINGS** screen will disappear.

To disable filter indicator

- When no filter is to be fitted, you can disable the filter indicator.
- Press and hold , ► and  buttons for 4 seconds to turn this off/on.
- When activated or deactivated the  icon will flash and on or off will be displayed in the FREEZER screen.
- We recommend that you do not disable the filter indicator if you have a filter fitted to the connection.

Important!

- *To avoid serious illness or death, do not use the water filter where water is unsafe or of unknown quality without adequate disinfection before or after use of filter.*
- *The water filter cartridge needs to be changed when the filter indicator icon flashes on the interface panel.*
- *We recommend the water filter cartridge is replaced when the  icon flashes. This will happen every 6 months.*
- *If the water filtration system has been allowed to freeze, replace filter cartridge.*
- *The rate of water flow through the water dispenser can slow down as the filter cartridge accumulates any sediment which may be present in the water supplied to your home. This varies depending upon your local water quality, which may require your filter cartridge to be changed more frequently.*
- *In cases of excessively reduced filter life we recommend that you consult a local plumber or your water supplier for advice on suitable filtration requirements for the water supplied to your home.*
- *Filter replacement is the consumer's responsibility and will not be covered by the warranty except in the case of faulty parts or materials within the filter cartridge.*
- *If the water has not been dispensed for some time or water has an unpleasant taste or odour, flush system by dispensing 10 litres (10 qt) of water.*
- *If unpleasant taste or odour persists, you may wish to fit a new filter cartridge.*



26 Using your ice maker (Ice & Water models only)

on

Ice maker

Your ice maker is designed to automatically dispense ice until it senses that the bin is full. So the more ice you use, the more it makes. It is even clever enough to sense when there is no bin in place to catch the ice and it will not dispense any ice.



First use

- When you first turn your refrigerator on after installation, the ice maker will be off.
- To turn your ice maker on use the  button to scroll to the **ICE** screen. Use the  or  button to turn the ice maker on or off.

on

 Shows the ice maker is on.

off Shows the ice maker is off.

- Press    together to force a cycle. The ice tray will flip. Force another cycle. The ice tray will flip and spill the water into the ice bin. Empty water and replace bin.
- If the bin is full of ice, inserted incorrectly or if all bins are removed, the ice maker will not operate. When the bin is inserted correctly the scoop will be on the right hand side of the bin for models E402B, E442B and E522B and at the front of the bin for RF540A models (refer to Fig.19).
- Once your ice maker is in operation, discard the first 3 harvests of ice (8 ice cubes are produced per harvest). This will flush away any impurities in the water line and ensure that you get the best quality ice. We recommend that you also do this after vacations or extended periods of not using ice.
- We recommend that you turn the ice maker off if:
 - The water supply is to be off for several hours, or
 - The ice storage bin is to be removed for a period of time, or
 - You are going on holiday/vacation.

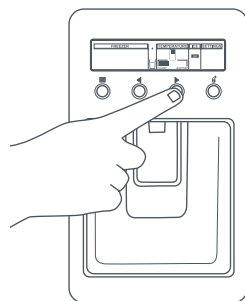
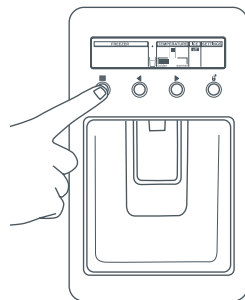
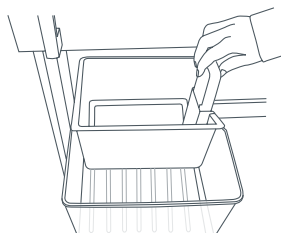
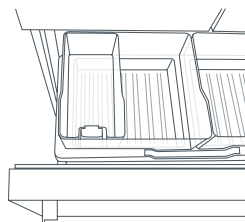

Fig.22 Turning ice maker on



E402B, E442B, E522B



RF540A

Fig.23 Ice storage bin and scoop in correct position

Information about your ice maker

- Your automatic ice maker will produce approximately eight cubes of ice every 2 – 3 hours, depending on freezer compartment temperature and number of door openings.
- The ice cube tray will fill with water once the freezer has reached the correct temperature.
- When cubes are frozen, they will be ejected from the mould into the ice storage bin.
- Ice making will continue until the storage bin is full.
- Ice making will resume when the ice is used.
- Your Ice & Water product comes with a smaller ice bin inside the larger freezer bin. Attached to this is the scoop for the ice. This scoop provides hygienic access to the ice.
- If a large amount of ice is required, remove the smaller storage bin and allow ice to fall into the larger bin.
- For maximum ice storage, level the stored cubes with the ice scoop.
- If ice is not used often, old cubes will become cloudy, taste stale, will shrink and may stick together. Empty the ice storage bin periodically and wash in lukewarm water. Dry thoroughly and place back in the correct position.

Important!

- *Avoid contact with the moving parts of the ice maker ejector mechanism, and do not place your fingers on the automatic ice making mechanism while the refrigerator is in operation.*
- *Do not use ice cubes that may have become discoloured, usually with a green-blue colour. If such discolouration is noted, discard the ice cubes and contact your Fisher & Paykel Authorised Repairer.*
- *Ensure the ice maker is connected to the filter and to a drinkable water supply only.*
- *Installation of the water connection to the ice maker must be completed by a qualified service technician or a qualified plumber (see installation instructions).*

Fruit and vegetable bins and humidity control lid

The fruit and vegetable bins feature a unique lid which provides two functions:

- The humidity lid seals the bins and provides a humid microclimate to extend storage times of fruit and vegetables.
- The humidity lid prevents condensation, which forms at high humidities, from dripping down onto the fruit and vegetables by retaining it in the grooves of the lid.

Fruit and vegetable bins and humidity slide

- Each fruit and vegetable bin has a humidity slide control that can be adjusted to a fruit or vegetable setting depending on what is stored in the bins.
- If possible try to store fruit and vegetables separately. This will help extend their storage life.
- If there is a mixture of fruit and vegetables in the bin adjust the position of the control to the centre.
- If there is too much water in the bins (due to the high humidity in the bins), the control can be adjusted towards the setting with fewer water drips (fruit setting) and/or the water can be wiped out as required.
- Remember a small amount of water in the bins is beneficial for fruit and vegetable storage.

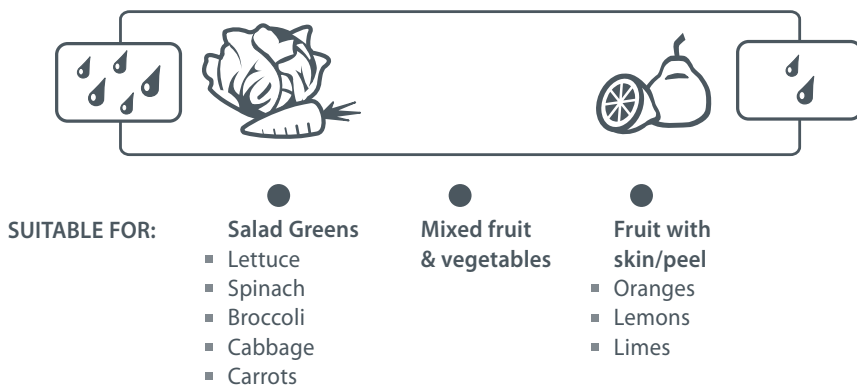

Fig.24 Humidity control graphic

Vegetable bin divider instructions (where fitted)

- To fit the divider, insert divider into bin on an angle, straighten and slot into place. To adjust the divider, fully extend the bin, partially lift the divider, slide sideways and re-slot into position.

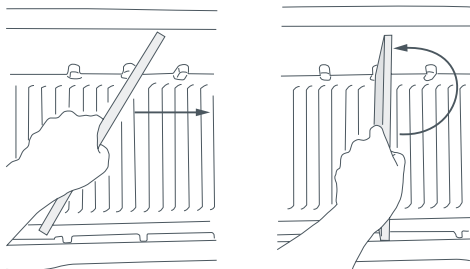

Fig.25 Vegetable bin divider

Slim storage drawer (where fitted)

The bins at the bottom of the refrigerator provide storage space for items that you may want to keep separate from the rest of the refrigerator. These slim storage bins can be used for deli item storage, beverages or defrosting foods.

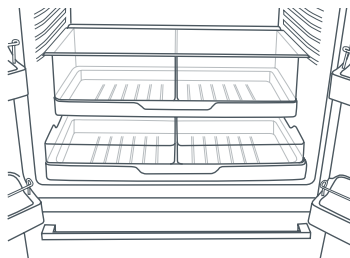

Fig.26 Slim storage drawer

Glass shelves

- Glass shelves can be repositioned in the cabinet as desired.
- Remove by lifting up at the back and pulling forward.

Bottle holder (where fitted)

- Your refrigerator will come with 2 – 4 single bottle holders (depending on what model refrigerator you have). The bottle holders can be used to store a variety of bottles.
- To position the bottle holder in your refrigerator, simply slot the back edge of the bottle holder onto the back trim of any shelf in the fresh food compartment.
- Unused bottle holders can be stacked up on top of one another so they do not take up unnecessary shelf space.
- Bottles are best stored with the neck of the beverage facing the front of the refrigerator.

Door alarms

- If the fresh food compartment door is left open an alarm will beep after 90 seconds and if the freezer door is left open an alarm will beep after 60 seconds.
- While either door remains open, subsequent beeps will sound every 30 seconds for 5 minutes.
- A continuous alarm will sound if either door has been left open for 5 minutes or longer and the light will also turn off. The alarm will stop when the opened door is closed.

Drip tray (Ice & Water models only)

- The drip tray is designed to fit under the lip at the bottom of the water dispenser panel.
- To insert the tray always ensure that the rounded sides are fitted under the lip at the bottom of the panel.
- The purpose of the tray is to capture any odd drips of water that may fall after dispensing.
- The tray can be easily removed for cleaning (see page 31).

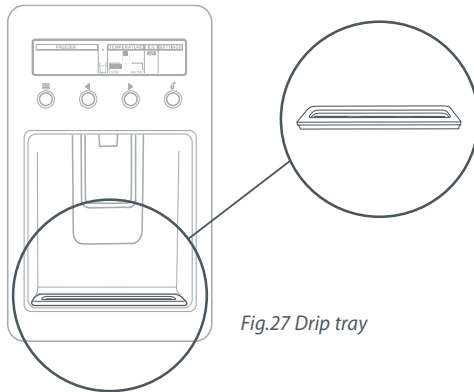

Fig.27 Drip tray

Ice trays and lid (where fitted)

- To empty the ice cubes into the lid, hold the tray and lid together and twist to dislodge.
- Refill the ice tray with water, place lid containing ice cubes on top and store in the freezer.
- Ice cubes are best stored in a closed container or plastic bag as they readily absorb odours and tastes from other foods.

Exterior

Stainless exterior doors (Iridium or EZKleen finishes)

- It is important when cleaning the exterior door surface of your refrigerator, to only use liquid dishwashing detergent dissolved in warm water, and a soft cloth.
- Dry the door with a clean, lint free cloth.
- The use of any abrasive or stainless steel cleaners and solvents will damage the door surface.

Other exterior surfaces

- Clean all other exterior surfaces with a mix of warm water and detergent and a soft cloth.
- If necessary, clean the magnetic door gasket and the centre door gaskets with an old toothbrush, warm water and liquid dishwashing detergent.

Water evaporator tray

- The water evaporator tray is found above the compressor at the back of the refrigerator. The tray may require infrequent cleaning.
- Carefully move the refrigerator out from the wall.
- Switch off the appliance.
- We do not recommend that you remove the evaporator tray. If cleaning is required, excess water can be soaked up from the evaporator tray using a sponge. Wipe out with warm water and detergent or disinfectant.
- Switch on the appliance.

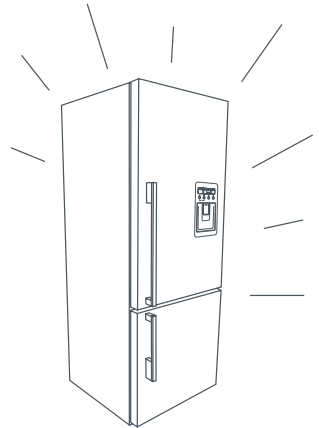

Water dispenser pad and interface (Ice & Water models)

- We have incorporated a Dispenser and Key Lock function in your refrigerator to make cleaning easier (refer to page 21). This will help you to avoid accidental water dispensing while you clean.
- Clean the pad and interface panel with a soft damp cloth.

Drip tray (Ice & Water models)

- To clean, take the tray out of the dispenser panel and pull the two halves of the tray apart.
- Clean in warm water with a mild detergent. Dry the tray and clip back together.
- Reinsert the tray back into the dispenser panel.

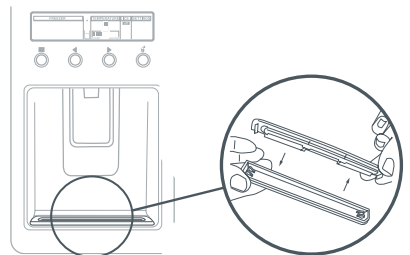

Fig.28 Cleaning the drip tray

Interior

- It is important to keep the interior of the refrigerator clean to help prevent food from becoming contaminated during storage.
- The amount and types of food stored determines how often cleaning should be carried out in the refrigerator (ideally once every 1 to 2 weeks).
- Remove the shelves from the fresh food and freezer compartment, including door shelves if applicable. Wash shelves and storage bins in warm water and detergent; rinse in clean water and dry before replacing.
- Wipe over the interior surfaces with warm water and detergent or baking soda dissolved in warm water (add 1 teaspoon of baking soda to each 500 ml (½ qt) of water). Rinse with clean water.
- To help remove “old stale refrigerator” smells add a few drops of vanilla essence or vinegar to the water before cleaning.
- Clean exterior surfaces with warm water and detergent. Use a toothbrush for the magnetic door gasket.
- Do not use harsh, abrasive cloths or cleaners or highly perfumed, strong smelling cleaners or solvents on any part of the refrigerator.

Glass shelves

- Clean with warm water and detergent or a glass cleaner. **If cleaning the shelves without removing from the cabinet, use only warm water and detergent as a glass cleaner can damage the plastic components of your refrigerator.**

Bottle holder (where fitted)

- Clean with warm water and detergent. The use of abrasive cleaners and solvents may cause damage.

Automatic ice dispenser (Ice & Water models)

- We do not recommend you clean the ice maker componentry, but it is important to clean the bins occasionally.
- The storage bin should be cleaned regularly and the old ice in the bottom of the bin discarded.
- Wash bin in lukewarm water. Dry thoroughly and replace.
- When replacing the bin ensure that the scoop is on the right hand side or at the front of the bin (model dependent).

Important!

Many commercially available cleaning products contain solvents that may attack the plastic components of your refrigerator and cause them to crack. It is important to use only warm water and a small amount of liquid dishwashing detergent on any plastic components inside and outside your refrigerator. Avoid using anti-bacterial cleaning products on either the interior or exterior of the cabinet as they may cause rusting of metal components and cracking of plastic components.

Humidity control system

Important!

When cleaning the shelf above the vegetable bins, we recommend that you do not disassemble the Humidity Control System from the shelf.

In the event that the humidity control lid (plastic lid) and humidity slides become separated from the glass shelf, follow these instructions to reassemble.

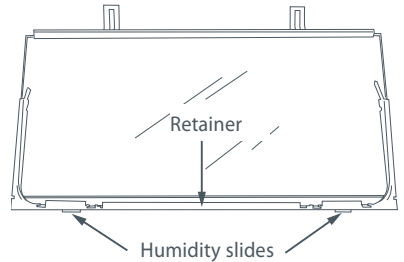

- 1 Turn shelf upside down
- 2 To attach humidity slides onto shelf front corners, fit bottom clips into shelf front trim. Next, slide sideways towards shelf until arm clips onto glass.

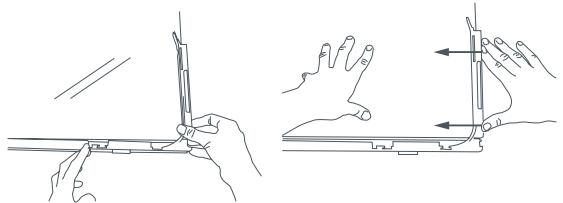

- 3 To attach humidity control lid – with text facing you, align lid with front of shelf. Hold lid vertically and fit front end into retainer on shelf. Ensure lid fits into retainer as well as underneath humidity slides.

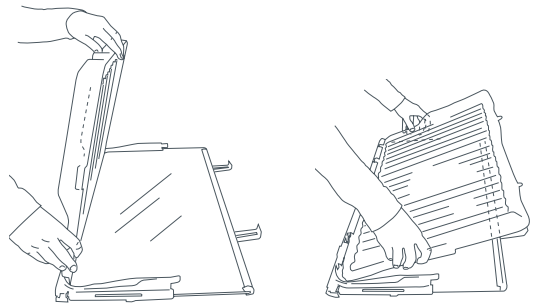

- 4 At the sides of the shelf, adjust humidity slide tabs so that the plastic lid is between the shelf and the tabs.
- 5 If clips on back of shelf are present, fasten lid with rear clips. Ensure that the cover is fully secure at front and back of shelf.

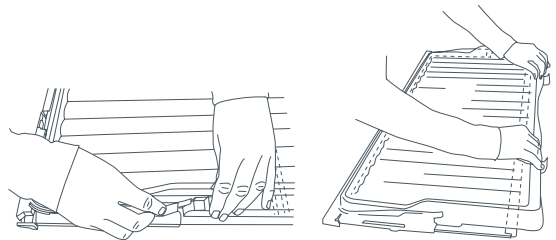

Fig.29 Humidity Control System cleaning

Cleaning and caring for your refrigerator (all models)

To remove trays or fixed bins

- For ease of removal, empty food from tray/bin first.
- Hold the centre front of the tray/bin handle.
- Lift vertically to unclip from the runners and pull tray/bin towards you to remove.
- Push both runners back into refrigerator.

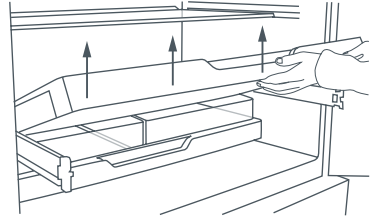

Fig.30 Tray removal

To replace trays or fixed bins:

- With the runners pushed back into the refrigerator, place the tray/bin on top of the runners. Push the tray/bin back slowly until you feel it clip back onto the runners.

Important!

- *Ensure that trays and bins are securely clipped onto the runners before use.*
- *Bin and tray runners are pre-lubricated, and will not need to be re-lubricated during their life. Do not attempt to clean grease from the runners, as this will affect their ability to function. Do not immerse runners in water.*

Permanently fixed bins and trays (RF540A model only)

The freezer bins and trays in this model are permanently fixed. They cannot be removed from the freezer compartment. To clean simply wipe with a soft, damp cloth.

On vacation/holiday

We recommend you leave your refrigerator operating while you are on holiday.

Ice & Water models

- Switch the ice maker to OFF on the interface panel (refer to page 26).
- Shut off the water supply to the refrigerator.
- On your return, turn on the water supply to the refrigerator.
- Dispense 10 litres (10 qt) of water and discard to ensure the water tank is refilled with fresh water.
- Turn on the ice maker (refer to page 26).
- Discard the first 3 harvests of ice (8 ice cubes are produced per harvest).

Normal refrigerator sounds

Active Smart™ refrigerators, with their excellent energy ratings and cooling performance, can produce sounds somewhat different to your old refrigerator.

Normal operational sounds include:

- Fan air flow sound. *Active Smart™* refrigerators have fans which change speed depending on demand. During cooling periods, such as after frequent door openings, fans circulate the cold air in the refrigerator and freezer compartments producing some air flow sounds, this is quite normal.
- Cracking or popping which may sound like ice coming off the evaporator. This occurs when the defrost function is operating.
- Running water sound. This is the liquid refrigerant in the system and can be heard as a boiling or gurgling noise.
- An audible hissing sound after closing the freezer door. This is due to the pressure difference between the warm air that has entered the cabinet and suddenly cooled, and the outside air pressure.
- Other strange sounds may be heard for the following reasons:
 - Cabinet not level.
 - Floor uneven or weak.
 - Bottles or jars rattling on shelves.
- If this is your first refrigerator with an ice maker, you will hear occasional sounds that may be unfamiliar. They are normal ice making sounds and are not cause for concern.
- The following sounds are normal with the operation of an ice maker:
 - Motor operation (low humming).
 - Running water as the ice maker and/or water tank fills.
 - Water valve opening and closing (hissing sound).
 - Ice being loosened from the ice moulding tray (cracking).
 - Ice dropping into bin (clunking).

Storing food in your refrigerator (all models)

Storing fresh, perishable foods in your refrigerator helps to extend storage times. The cold temperatures slow down the major causes of food spoilage – namely, the growth of bacteria, moulds and yeasts, and chemical and physical reactions.

Fresh food care

The quality of food before it is placed in the refrigerator is critical to successful storage. For best results:

- Select foods that are very fresh and of high quality.
- Buy only the amount that you will use within the recommended storage time. If you buy extra, plan to freeze it.
- Ensure that food is well wrapped or covered before it is stored. This will prevent food from dehydrating, deteriorating in colour or losing flavour and will help maintain freshness. It will also prevent odour transfer. Fruit and vegetables need not be wrapped provided they are stored in the vegetable bins of the refrigerator.
- Make sure that strong smelling foods are wrapped or covered and stored away from foods such as butter, milk and cream which can be tainted by strong odours.
- Refrigerate fresh, perishable foods as soon as possible after purchase. If left at room temperature for any length of time the rate of deterioration will be accelerated.
- Avoid placing food directly in front of air outlets, as it may freeze and cold air needs to circulate to maintain safe food storage.
- Do not open the refrigerator door unnecessarily.
- Cool hot foods down before placing them in the refrigerator. This should be done quickly. It can be aided by placing the container of food in a bowl of ice and water; renew the ice as necessary. (Note also that hot containers may damage shelves and walls of the refrigerator).
- Store raw and cooked food in separate containers or packaging to prevent cross contamination.

In addition:

- Keep the refrigerator clean. Wipe the inside walls and shelves frequently (refer to Cleaning Care) and place only clean containers in the refrigerator.
- Keep a close check on the quality of food in your refrigerator. Discard any food that shows signs of spoilage. Pay particular attention to meat, fish and poultry, as these foods are highly perishable. Use food within the recommended storage times.

Dairy foods and eggs

- Most pre-packed dairy foods have a recommended 'use by/ best before/best by' date stamped on them. Store them in the refrigerator and use within the recommended time.
- Butter can become tainted by strong smelling foods so it is best stored in a sealed container.
- Eggs should be stored in the refrigerator. For best results, especially when baking, remove the eggs from the refrigerator two hours before they are to be used.



Red meat

- Place fresh red meat on a plate and loosely cover with waxed paper, plastic wrap or foil.
- Store cooked and raw meat on separate plates. This will prevent any juices lost from the raw meat contaminating the cooked product.
- Delicatessen meats should be used within the recommended storage time.



Poultry

- Fresh whole birds should be rinsed inside and out with cold running water. Dry and place on a plate. Cover loosely with plastic wrap or foil.
- Poultry pieces should also be stored this way. Whole poultry should never be stuffed until just before cooking, otherwise food poisoning may result.
- Cool and refrigerate cooked poultry quickly. Remove stuffing from poultry and store separately.



Fish and seafood

- Whole fish and fillets should be used on the day of purchase. Until required, refrigerate on a plate loosely covered with plastic wrap, waxed paper or foil.
- If storing overnight or longer, take particular care to select very fresh fish. Whole fish should be rinsed in cold water to remove loose scales and dirt and then patted dry with paper towels. Place whole fish or fillets in a sealed plastic bag.
- Keep shellfish chilled at all times. Use within 1 – 2 days.

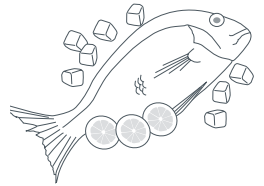

Precooked foods and leftovers

- These should be stored in suitable covered containers so that the food will not dry out.
- Keep for only 1 – 2 days.
- Reheat leftovers only once and until steaming hot.

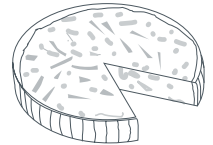

Fruit and vegetable bins

- Although most fruit and vegetables keep best at low temperatures, take care not to store the following at temperatures of less than 7°C for long periods: citrus fruit, tropical fruit, tomatoes, cucumbers.
- Undesirable changes will occur at low temperatures such as softening of the flesh, browning, accelerated decaying and/or loss of flavour.
- Do not refrigerate avocados (until they are ripe), bananas, mangoes or pepinos.
- If possible store fruit and vegetables separately, ie fruit in one bin and vegetables in the other.
- Each fruit and vegetable bin has a humidity control slide that can be adjusted depending on what is stored in the bins. For more information on using the Humidity Control refer to page 28.

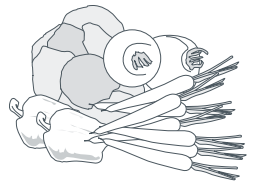

Storing food in your freezer (all models)

The use of temperatures of -18°C or colder to store food means that the food can be kept for longer periods than when refrigeration temperatures are used. This is because the growth of bacteria, moulds and yeasts are stopped, and chemical and physical reactions are severely restricted at such low temperatures.

Frozen food care

For best results:

- Choose only high quality foods that freeze well.
- Store at -18°C or colder. Take care to maintain this low storage temperature, eg try to avoid opening the freezer door unnecessarily. If your ice cream is soft you are running your freezer too warm.
- Leave space at the top of containers, jars or plastic bags containing liquids or semi-solid foods. These expand as they freeze. Usually 20 – 50 mm head space is recommended. Seal. Ideally, remove all the air from the package after food is frozen.
- Packages or containers of solid foods should have the air removed from them and be sealed tightly before freezing.
- Freeze immediately or as quickly as possible. Freeze only small quantities of food at any one time. For best results we recommend that only 1 kg of food be frozen per 25 L freezer storage volume. (About 3 kg in small freezers and 4 kg in larger freezers). For faster freezing we recommend that fresh food is placed at the top of the freezer compartment close to the air vent.
- Do not pile frozen food around the fan cover. It can prevent adequate air circulation.
- Thaw foods preferably in a refrigerator, or using a microwave oven or multifunction oven.
- Keep a constant turnover of food. Use older items of food first. Do not exceed recommended storage times.
- Use good quality freezer proof packaging to maintain food quality.
- If food is only covered in plastic film place inside a freezer-proof plastic bag.



Recommended freezer storage times

These times should not be exceeded.

	M o n t h s	1	Bacon, casseroles, milk
		2	Bread, ice cream, sausages, pies – (meat and fruit), prepared shellfish, oily fish
		3	Non-oily fish, shellfish, pizza, scones and muffins
		4	Ham, cakes, biscuits, beef and lamb chops, poultry pieces
		6	Butter, vegetables (blanched), eggs whole and yolks, cooked crayfish, minced meat (raw), pork (raw)
		12	Fruit (dry or in syrup), egg whites, beef (raw), whole chicken, lamb (raw), fruit cakes

Meat, poultry and game

- Do not try to freeze more than 1 kg meat per 25 L freezer storage volume, at any one time. Meat must be frozen quickly in order to maintain its texture.
- Do not stuff poultry before freezing.
- Red meat can be cooked from frozen, or from the partly or completely thawed states. Remember to allow extra cooking time if cooking from frozen.
- Always thaw poultry completely before cooking.



Fish

- Fish is best frozen commercially. If, however, you do want to freeze fish at home, make sure the fish is very fresh and of high quality.
- Clean, scale and preferably leave whole. All fish should be wrapped in two layers of packaging as depending on the type of fish, odours and flavours can be readily transferred either to or from it. Seal well.
- For best results, cook from either the frozen or partly thawed state.

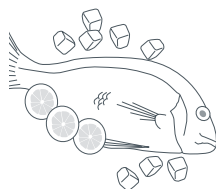

Vegetables

- Most vegetables freeze well, although 'salad' vegetables lose their crispness. Other vegetables, eg celery, onion and tomatoes, should only be used in cooked dishes as they soften on freezing.
- Freeze only high quality, mature, ready-to-eat vegetables.
- Sort and discard any vegetables that are damaged.
- It is necessary to blanch most raw vegetables prior to freezing.
- Blanching involves a short cooking period during which vegetable enzymes are destroyed. If these enzymes are not destroyed they cause undesirable physical and chemical changes during freezer storage.
- Vegetables can be blanched in boiling water, steam or microwave oven. If using boiling water, boil vegetables for 2 – 4 minutes and cool quickly.
- In general frozen vegetables are best cooked from their frozen state.

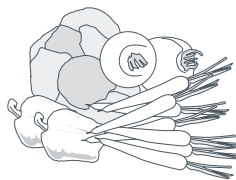

Prepared and cooked foods

- Most cooked foods can be frozen but it is not recommended to freeze the following:

Cooked egg white, custards, cream fillings and milk puddings, gelatine or jelly-like dishes, mayonnaise and similar salad dressings, meringue toppings. These tend to separate on thawing.

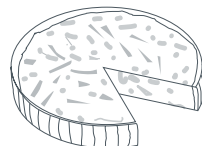





Fruit

- Choose high quality, mature, and ready to eat fruit. Preferably select varieties recommended for freezing.
- Avoid unripe and over-ripe fruit.
- The way fruit is packed depends on how it is to be used. Fruits packed in syrup are ideal for desserts, whereas fruits packed without sugar are better used for cooking. Most fruits can be stored for 8 – 12 months.





Troubleshooting (all models)

If there is a problem with your appliance, please check the following points before contacting your local Fisher & Paykel Appliances Authorised Service Centre Dealer or Customer Care Centre.

Problem	Possible causes	What to do
Appliance does not operate.	No electricity at power outlet.	Check that the plug is correctly connected and power switched on. Check another appliance at the same outlet. Check house fuse.
Light not working.	Light not functioning.	The light cannot be serviced by the user. Contact your Fisher & Paykel Dealer or Authorised Service Agent.
	Refrigerator not working.	Check refrigerator is turned on at wall. If problem continues refer to page 44.
Light and display not working.	Product in Sabbath Mode.	On Ice & Water models hold down  ,  and  buttons for 4 seconds. On Non-Ice & Water models hold the  button down for 10 seconds.
Motor operates for long periods.	Hot weather. Frequent door openings. Large amount of food recently added.	Minimise door opening to allow temperature to stabilise.
	Temperature control set too low.	See Temperature control section (refer to page 21 for Ice & Water models and page 16 for Non-Ice & Water models).
	Doors not sealing properly.	Check that cabinet is level and gasket seals are clean.
Storage compartments too warm.	Temperature setting not correct.	See Temperature control section (refer to page 21 for Ice & Water models and page 16 for Non-Ice & Water models).
	Frequent door openings. Large amount of food recently added.	Minimise door openings to allow temperature to stabilise.
Food freezing in the refrigerator.	Temperature setting not correct.	See Temperature control section (refer to page 21 for Ice & Water models and page 16 for Non-Ice & Water models).
	Food placed directly in front of air outlets.	Move chill sensitive foods away from the centre back of the shelf.
Unfamiliar noises.	Cabinet not stable or level.	See Installation section (pages 12 – 13) or refer to Refrigerator sounds (page 35).
	Freezer is defrosting.	

Problem	Possible causes	What to do
Condensation/ water in the vegetable bins.	Condensation is formed by the water produced by fruit and vegetables.	<p>A small amount of condensation is beneficial for fruit and vegetable storage. If there is too much water, store fruit and vegetables loosely wrapped in plastic bags. Wipe out water with a cloth.</p> <p>Set humidity slide to low humidity setting. </p>
Sides of cabinet are warm.	This is normal.	
Condensation on outside of refrigerator.	Not unusual during periods of high humidity.	Wipe dry.
Condensation inside fresh food compartment.	Frequent or long door openings.	Minimise door openings.
	Door gasket leaking.	Check that gasket is sitting flat and sealing tightly.
	Not unusual during periods of high humidity.	Wipe dry.
Ice buildup inside freezer compartment.	Freezer door not closing tightly.	<p>Move items in freezer so door can close tightly.</p> <p>Check and clean door gasket seal.</p>
Door handles out of alignment.	With time and usage, movement may occur.	See Installation: four alignment essential requirements – Stability instructions (refer to pages 12 – 13).
Tray/bin does not slide in and out evenly.	Packaging trapped.	Check to ensure no food or packaging is trapped behind the tray/bin.
	Runners not extending fully.	Holding onto sides of tray/bin, extend the runners fully by using a firm pull – this will reset the runner.

Problem	Possible causes	What to do
Ice maker makes unfamiliar sounds or seems too loud.	Normal ice maker operation.	Refer to Refrigerator sounds (refer to page 35).
Automatic ice maker does not work.	Ice maker has not been switched on.	Switch on ice maker (refer to page 26).
	Bin is in the wrong way or there is no bin in place.	Place bin so scoop is on the right side. Ice bin sits directly under ice maker on top left side of freezer.
	Water supply turned off or not connected.	Connect water supply.
	Water pressure too low.	Check water pressure.
	Water line kinked/squashed.	Check water line for kinks/squashing.
	Filter clogged.	Water filter may need replacing.
Ice cubes have odour/taste.	Unsealed packages may be transmitting odour/taste.	Old cubes need to be discarded. Ensure food packaging is sealed.
	Interior of freezer needs cleaning.	Ice storage bin needs to be emptied and washed. Clean refrigerator (refer to pages 31 – 34).
	Poor taste from incoming water.	Filter may need changing. A filter may need to be installed.
Slow ice cube freezing.	Door may have been left ajar.	Close door.
	Freezer compartment too warm.	Turn temperature to a colder setting (refer to page 21).
Warm spot on central door seal.	You may feel a warm spot at times on the central seal between the two refrigerator doors.	This is perfectly normal and is part of the normal refrigerator operation.
Wet ice/ ice clumping.	Low water pressure.	Check water pressure.
	Filter blocked.	Replace filter (refer to pages 24 – 25).
	Long freezer door openings High ambient temperature Ice bin left out of freezer compartment for a length of time.	Gently tap ice with scoop to unstick or, if large clumps occur, empty ice bin and make new ice.
	Ice will stick together over time.	

Problem	Possible causes	What to do
Water has poor taste/odour.	Refrigerator not used for an extended period.	Dispense 10 L (10 qt) of water so fresh water supply is replenished.
Water dispenser does not work.	Water supply turned off or not connected.	Turn water on. Press dispenser for 2 minutes to remove trapped air from water line and to fill the water system.
	Supply line may be blocked. On first installation there may be air in water system.	Check supply for kinks or leaks. To remove air, run a litre or a quart of water through the dispenser.
	Filter may be blocked and need replacing.	Replace filter.
	Dispenser Lock activated.	Hold down the  button for 2 seconds.
	Water frozen in tank.	Increase temperature to a warmer setting in fresh food compartment and freezer.
Water in first glass is warm.	Water dispenser not used for extended period.	Discard first glass of water dispensed.
	Tank capacity used recently.	Allow water time to cool.
Filter warning light  is flashing.	Filter needs replacing.	Replace filter as soon as possible (refer to pages 24 – 25).
Drips overflow drip-shelf.	Air trapped in tank.	Flush 3 L (3 qt) water through dispenser, stopping intermittently.
	New filter installed.	Flush 10 L (10 qt) water through filter and then 3 L (3 qt) through dispenser.
Water flow rate has slowed down.	Filter cartridge is restricted.	Replace filter as soon as possible (refer to pages 24 – 25).

Before you call for service or assistance...

Check the things you can do yourself. Refer to your User Guide and check that:

- 1 Your appliance is correctly installed
- 2 You are familiar with its normal operation
- 3 You have read the Problem Solving Checklist

If after checking these points you still need assistance please refer to the following:

Europe

www.fisherpaykel.eu

If you call or write, please provide; name and address, model number, serial number, date of purchase and a complete description of the problem. This information is needed in order to better respond to your request for assistance.

Product details

Fisher & Paykel Appliances Ltd

Model/Serial No.

Date of Purchase _____ **Purchaser** _____

Dealer _____ **Suburb** _____

Town _____ **Country** _____

Waste Electrical and Electronic Equipment (WEEE)

GB This appliance is marked according to the European directive 2002/96/EC on Waste Electrical and Electronic Equipment (WEEE). By ensuring this product is disposed of correctly, you will help prevent potential negative consequences for the environment and human health, which could otherwise be caused by inappropriate waste handling of this product.

The symbol  on the product, or on the documents accompanying the product, indicates that this appliance may not be treated as household waste. Instead it shall be handed over to the applicable collection point for the recycling of electrical and electronic equipment. Disposal must be carried out in accordance with local environmental regulations for waste disposal.

For more detailed information about treatment, recovery and recycling of this product, please contact your local city office, your household waste disposal service or the shop where you purchased the product.

State of California
Department of Health Services
Water Treatment Device
Certificate Number

06 - 1806

Date Issued: July 18, 2006

Trademark/Model Designation

Fisher & Paykel 836860

Replacement Elements

836848

Manufacturer: Cuno Incorporated

The water treatment device(s) listed on this certificate have met the testing requirements pursuant to Section 116830 of the Health and Safety Code for the following health related contaminants:

Microbiological Contaminants and Turbidity

Cysts
Turbidity

Organic Contaminants

Atrazine
Benzene
Carbofuran
Lindane
p-dichlorobenzene
Toxaphene

Inorganic/Radiological Contaminants

Asbestos
Lead
Mercury

Rated Service Capacity: 750 gal

Rated Service Flow: 0.78 gpm

Conditions of Certification:

Do not use where water is microbiologically unsafe or with water of unknown quality, except that systems certified for cyst reduction may be used on disinfected waters that may contain filterable cysts.

Performance Data Sheet For Fisher & Paykel Filter System Model: 836860

Replacement Cartridge: 836848

This system has been tested according to NSF/ANSI 42 and 53 for the reduction of the substances listed below. The concentration of the substances in water entering the system was reduced to a concentration less than or equal to the permissible limit for water leaving the system as specified in NSF/ANSI 42 & 53. System tested and certified by NSF International against NSF/ANSI Standard 53 for the reduction of Asbestos, Atrazine, Benzene, Cyst, Carbofuran, Lead, Lindane, Mercury, P-Dichlorobenzene, Toxaphene and Turbidity; against Standard NSF/ANSI 42 for the reduction of Chlorine Taste and Odor and Nominal Particulate Class 1.



To a capacity of 2,838 liters (750 gallons)

Substance	USEPA MCL	Standard 53: Health Effects					
		Influent Challenge concentration (mg/L)		Influent		Effluent	
		Average	#L	Average	#L	Average	#L
Turbidity	1 NTU**	11±1 NTU**	10.7 NTU**	0.31 NTU**	0.49 NTU**	95.20%	0.5 NTU**
Cysts	99.95% reduction	Minimum 50,000 #/L	166500 #/L	<1 #/L	<1 #/L	<99.99%	>99.95%
Asbestos	99% reduction	10 ⁷ to 10 ⁸ fibers/L; fibers greater than 10 um in length	155 MF/L	<1 MF/L	<1 MF/L	<99.99%	>99%
Lead @ pH 6.5	0.015 mg/L	0.15mg/L ±10%	0.153 mg/L	<0.001 mg/L	<0.001 mg/L	99.35%	0.010 mg/L
Lead @ pH 8.5	0.015 mg/L	0.15mg/L ±10%	0.150 mg/L	<0.001 mg/L	<0.001 mg/L	99.33%	0.010 mg/L
Mercury @ pH 6.5	0.002 mg/L	0.006mg/L ±10%	0.006 mg/L	0.0003 mg/L	0.0005 mg/L	96.70%	0.002 mg/L
Mercury @ pH 8.5	0.002 mg/L	0.006mg/L ±10%	0.006 mg/L	0.0008 mg/L	0.0015 mg/L	86.22%	0.002 mg/L
Atrazine	0.003 mg/L	0.009mg/L ±10%	0.009 mg/L	<0.002 mg/L	<0.002 mg/L	76.99%	0.003 mg/L
Benzene	0.005 mg/L	0.015mg/L ±10%	0.014 mg/L	0.0006 mg/L	0.0011 mg/L	95.71%	0.005 mg/L
Carbofuran	0.04 mg/L	0.08mg/L ±10%	0.081 mg/L	<0.001 mg/L	<0.001 mg/L	98.74%	0.04 mg/L
p-dichlorobenzene	0.075 mg/L	0.225mg/L ±10%	0.208 mg/L	<0.0005 mg/L	<0.0005 mg/L	99.76%	0.075 mg/L
Lindane	0.0002 mg/L	0.002mg/L ±10%	0.002 mg/L	0.000025 mg/L	0.00007 mg/L	98.72%	0.0002 mg/L
Toxaphene	0.003 mg/L	0.015±10%	0.015 mg/L	<0.001 mg/L	<0.001 mg/L	92.97%	0.003 mg/L

Standard 42: Aesthetic Effects

Substance	USEPA MCL	Standard 42: Aesthetic Effects					
		Influent Challenge concentration (mg/L)		Effluent		% Reduction	
		Average	#/ml	Average	#/ml	Average	Maximum
Chlorine Taste & Odor	~	2.0mg/L ±10%	1.88 mg/L	0.051366364 mg/L	0.06 mg/L	97.26%	96.84%
Nominal Particulate*	~	at least 10,000 particulates/mL	5,700,000 #/ml	30:583 #/ml	69,000 #/ml	99.95%	98.94%

* Measurement in Particles/ml. Particles used were 0.5 - 1 microns.

**NTU = Nephelometric Turbidity Units

Operation Specifications	
Water pressure	172-827 kPa (25-120psi)
Water temperature	0.6-38°C (33-100°F)
Service flow	2.9 lpm (.75 gpm)
Filter capacity	2,838 liters (750gallons)

Systems must be installed and operated in accordance with manufacturer's recommended procedures and guidelines. Follow any and all local plumbing codes and requirements. Some local codes may require the use of a licensed plumber or a certified installer when disrupting a potable water line.

Important: Failure to follow instructions may result in voidance of warranty.

©3M Company. All rights reserved.
INSTR7069 0706

IMPORTANT: Change the filter cartridge at least every 6 months.

CAUTION: To reduce the risks associated with water leakage, which, if not avoided, may result in property damage - check with your plumbing professional to verify that water pressure is less than 827 kPa (120 psi).

For estimated cost of replacement element, please call 1-888-936-7872 or contact your local appliance distributor or dealer.



Manufactured by : CUNO Incorporated, a 3M Company
1000 Apollo Road
Eagan, MN 55121

www.fisherpaykel.eu

Fisher & Paykel

Copyright © Fisher & Paykel 2011. All rights reserved.

The product specifications in this booklet apply to the specific products and models described at the date of issue. Under our policy of continuous product improvement, these specifications may change at any time. You should therefore check with your Dealer to ensure this booklet correctly describes the product currently available.