

# Haier

## Customer Service

We recommend our Haier Customer Service and the use of original spare parts.

If you have a problem with your appliance, please first check section TROUBLESHOOTING.

If you cannot find a solution there, please contact

- ▶ your local dealer or
- ▶ the Service & Support area at [www.haier.com.au](http://www.haier.com.au)  
or at [www.haier.co.nz](http://www.haier.co.nz)

where you can activate the service claim and also find FAQs.

To contact our Service, ensure that you have the following data available. The information can be found on the rating plate at the door.

Model \_\_\_\_\_

Serial No. \_\_\_\_\_

## User Manual Free Standing Cooker

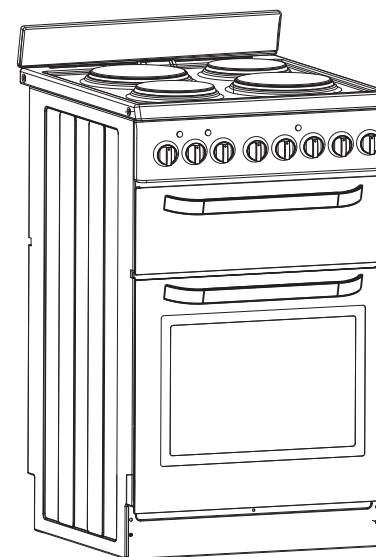

HOR54B5MCW1

## DEAR CUSTOMER

---

This appliance has been designed to be efficient and easy to use. The following instructions will show you how to best operate your appliance to enjoy years of hassle-free use.

It is important to keep this instruction manual and store it in a safe place so that it can be consulted at any time.

For your peace of mind, this appliance has been thoroughly tested with regard to safety and functionality before leaving the factory.

### Caution!

Do not use this appliance until you have read this instruction manual.

This appliance is intended for household use only.

## TABLE OF CONTENTS

---

Safety instructions.....	3
How to save energy.....	4
Unpacking.....	5
Disposal of the appliance.....	5
Description of the appliance.....	6
Installation .....	7
Operation .....	8
Before first use.....	8
How to use the heating plate .....	9
Operating the grill/top oven .....	10
Operating the fan oven .....	12
Oven functions and operation .....	13
Mechanical timer .....	13
Cleaning and maintenance.....	16
Operation in case of emergency.....	20
Technical information.....	21
Electrical connection.....	22

## SAFETY INSTRUCTIONS

- The appliance becomes hot during operation. Take care not to touch the hot parts inside the oven.
- Always keep children away from the cooker. While in operation direct contact with the cooker may cause burns!
- Ensure that small items of household equipment, including connection leads, do not touch the hot oven or the hob as the insulation material of this equipment is usually not resistant to high temperatures.
- Do not leave the cooker unattended when frying. Oils and fats may catch fire due to overheating.
- Do not allow the cooktop to get soiled and prevent liquids from boiling over onto the surface of the cooktop. Any spillages should be cleaned up as they happen.
- Do not place pans with a wet bottom on the warmed up heating zones as this can cause irreversible changes to the cooktop (irremovable stains).
- Do not switch on the cooktop until a pan has been placed on it.
- Do not put pans weighing over 15kg on the opened door of the oven and pans over 25kg on the cooktop.
- Do not use harsh cleaning agents or sharp metal objects to clean the doors as they can scratch the surface, which could then result in the glass cracking.
- Do not use the cooker in the event of a technical fault. Any faults must be fixed by an appropriately qualified and authorized person.
- In the event of any incident caused by a technical fault, disconnect the power and report the fault to the service centre to be repaired.
- The rules and provisions contained in this instruction manual should be strictly observed. Do not allow anybody who is not familiar with the contents of this instruction manual to operate the cooker.
- The cooker should not be cleaned using steam equipment.
- **WARNING:** In order to prevent accidental tipping of the appliance, for example by a child climbing onto the open door, the stabilizing means must be installed.
- The oven must be switched off before removing the guard and that, after cleaning, the guard must be replaced in accordance with the instructions.
- Ensure that the appliance is switched off before replacing the lamp to avoid the possibility of electric shock.
- **WARNING:** Accessible parts will become hot when the grill is in use. Children should be kept away.
- The appliance is not intended to be operated by means of an external timer or separate remote-control system.
- This appliance is not intended for use by persons (including children) with reduced physical, sensory or mental capabilities, or lack of experience and knowledge, unless they have been given supervision or instruction concerning use of the appliance by a person responsible for their safety.
- Children should be supervised to ensure that they do not play with the appliance.
- If the supply cord is damaged, it must be replaced by the manufacturer or its service agent or a similarly qualified person in order to avoid a hazard.
- Use pans that are specified by the manufacturer as designed for use with a ceramic hob.
- If the surface is cracked, switch off the appliance to avoid the possibility of electric shock.

## SAFETY INSTRUCTIONS

Do not use pans with sharp edges that may cause damage to the ceramic hob.  
Do not look directly at the halogen heating zone (not covered with a pan) when they are warming up.

## HOW TO SAVE ENERGY



Using energy in a responsible way not only saves money but also helps the environment. So let's save energy!

- Use proper pans for cooking. Pans with thick, flat bases can save up to 1/3 on electric energy. Remember to cover pans if possible otherwise you will use four times as much energy!
- Match the size of the saucepan to the surface of the heating plates. A saucepan should never be smaller than a heating plate.
- Ensure heating plates and pan bases are clean. Soils can prevent heat transfer and repeatedly burnt-on spillages can often be removed by products which cause damage to the environment.
- Do not uncover the pan too often (a watched pot never boils!). Do not open the oven door unnecessarily often.
- Switch off the oven in good time and make use of residual heat.

For long cooking times, switch off heating zones 5 to 10 minutes before finishing cooking. This saves up to 20% on energy.

- Only use the oven when cooking larger dishes. Meat of up to 1 kg can be prepared more economically in a pan on the cooker burner.
- Make use of residual heat from the oven. If the cooking time is greater than 40 minutes it is recommended to switch off the oven 10 minutes before the end time.

### **Caution!**

When using the timer set appropriately shorter cooking times according to the dish being prepared.

- Never operate the oven with the door ajar, including when grilling.
- Make sure the oven door is properly closed. Heat can leak through spillages on the door seals. Clean up any spillages immediately.
- Do not install the cooker in the direct vicinity of refrigerators/freezers. Otherwise energy consumption increases unnecessarily.

## UNPACKING



During transportation, protective packaging was used to protect the appliance against any damage.

After unpacking, please dispose of all elements of packaging in a way that will not cause damage to the environment. All materials used for packaging the appliance are environmentally friendly; they are 100% recyclable and are marked with the appropriate symbol.

### **Caution!**

During unpacking, the packaging materials (polythene bags, polystyrene pieces, etc.) should be kept out of reach of children.

## DISPOSAL OF THE APPLIANCE



Old appliances should not simply be disposed of with normal household waste, but should be delivered to a collection and recycling centre for electric and electronic equipment.

A symbol shown on the product, the instruction manual or the packaging shows if it is suitable for recycling.

Materials used inside the appliance are recyclable and are labelled with information concerning this. By recycling materials or other parts from used devices you are making a significant contribution to the protection of our environment.

Information on appropriate disposal centers for used devices can be provided by your local authority.

## DESCRIPTION OF THE APPLIANCE

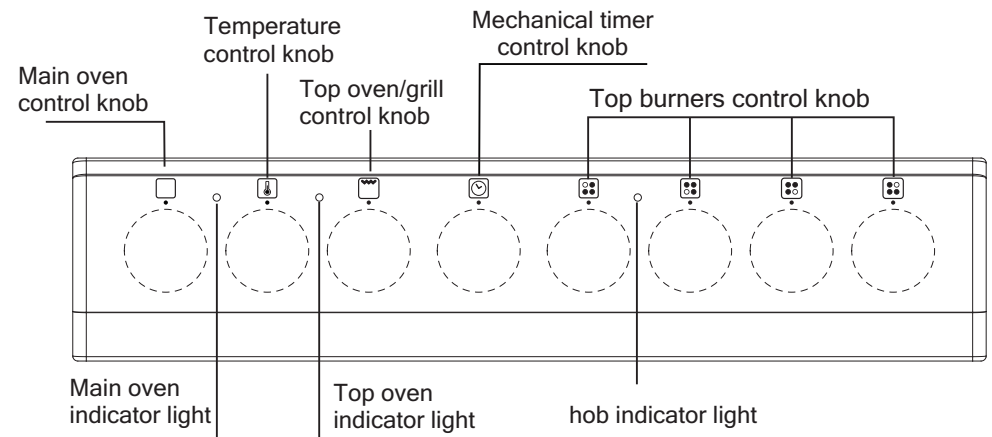
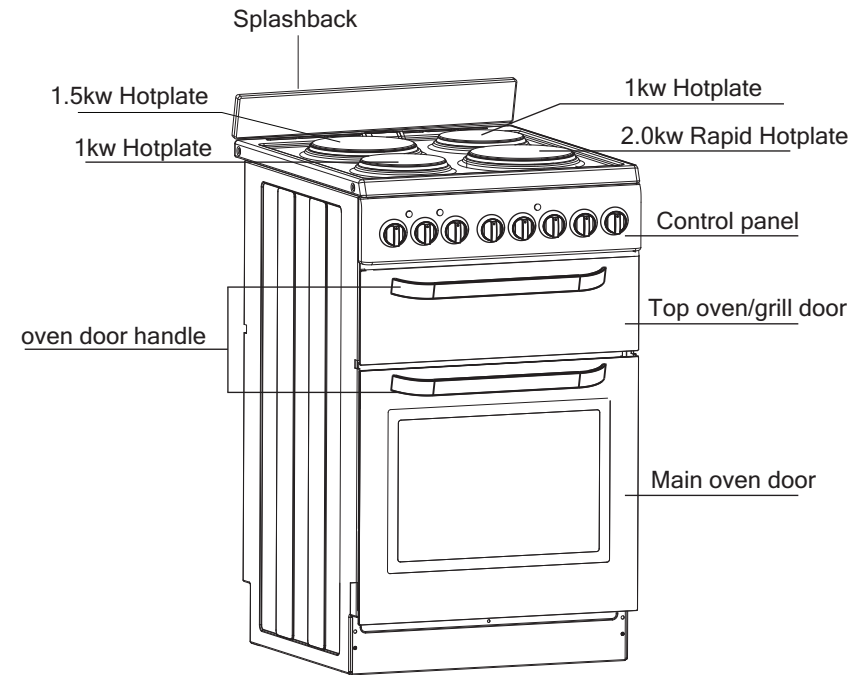

## INSTALLATION

### ▷ Installing the cooker

- The kitchen where the appliance is to be installed must be dry and well ventilated.
- The room should be equipped with a ventilation system that pipes away exhaust fumes created during combustion. This system should consist of a ventilation grid or hood. Hoods should be installed according to the manufacturer's instructions. The cooker should be placed so as to ensure free access to all control elements.
- Coating or veneer used on fitted furniture must be applied with a heat resistant adhesive (100°C). This prevents surface deformation or detachment of the coating. If you are unsure of your furniture's heat resistance, you should leave approximately 2 cm of free space around the cooker. The wall behind the cooker should be resistant to high temperatures. During operation, its back side can warm up to around

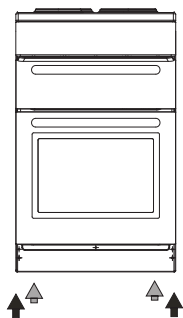
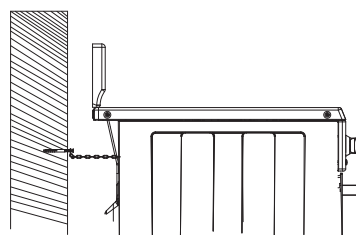
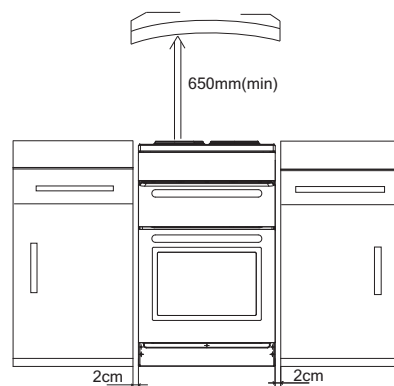

#### Fix the cooker to the back wall with 2 chains

- The cooker should stand on a hard, even floor (do not put it on a base.)
- Before you start using the cooker it should be leveled, which is particularly important for fat distribution in a frying pan. To this purpose, adjustable feet are accessible after removal of the drawer. The adjustment range is +/-5mm.

## INSTALLATION

- To fit the rear panel/splashback, slide the lugs on the bottom of the panel into the matching slots on rear of stove and fix with screws provided.

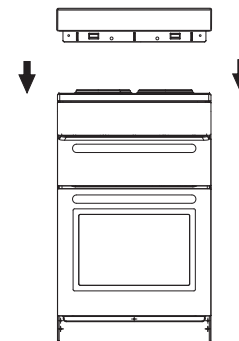

## OPERATION

### ▷ Before first use

- Remove packaging and empty the drawer. Clean the interior of the oven with warm soapy water and wipe clean with oiled cloth or sponge. Wipe clean the cooktop.
- Take out and wash the oven fittings with warm water and a little washing-up liquid.
- Switch on the ventilation in the room or open a window.
- Heat the oven (to a temperature of 250°C, for approx. 30 min.), remove any stains and wash carefully. The hotplates should be heated for around 4 minutes without a pan or pot on them.
- When heating the oven for the first time it is normal for the stove to give off smoke and manufacturing odours. These will disappear after about 30 Minutes.

## OPERATION

### Use

Do not use pots and pans that are unsteady and likely to rock or overbalance.  
Do not operate the cooktop for an extended time without utensil on the hotplate.

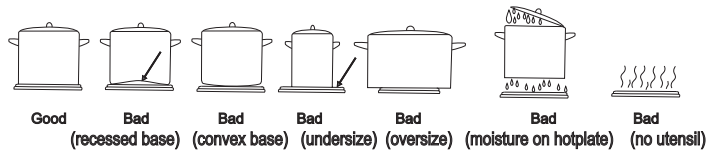

### Caution!

Ensure the plate is clean—a soiled zone does not transfer all of the heat.  
Protect the plate against corrosion.  
Switch off the plate before a pan is removed.  
Do not leave pans with prepared dishes based on fats and oils unattended on the switched—on plate; hot fat can spontaneously catch fire.

### How to use the heating plate

When any hotplate is activated the RED signal light will remain on.  
The level of heat can be adjusted gradually by turning the appropriate knob to the right or left.  
Switching on the plate results in a RED signal light on the control panel turning on.

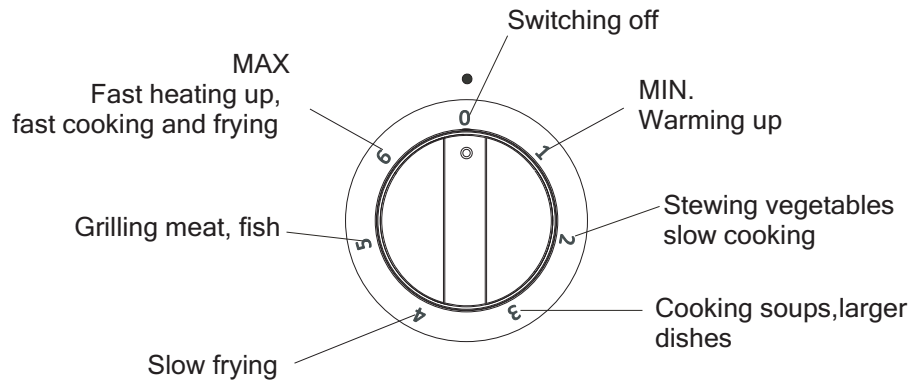

An appropriately selected pan saves energy.  
A pan should have a thick, flat base with a diameter equal to the plate diameter, as in that case heat is transferred most efficiently.

### Caution!

Ensure the plate is clean—a soiled zone does not transfer all of the heat.  
Protect the plate against corrosion.  
Switch off the plate before a pan is removed.  
Do not leave pans with prepared dishes based on fats and oils unattended on the switched—on plate; hot fat can spontaneously catch fire.

## OPERATION

### Operating the grill/top oven

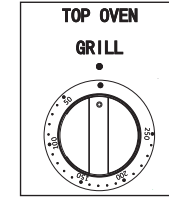

### Caution!

Do not touch the heating elements or other parts that may become hot when the grill/top oven is in use—children must be kept away.  
A switch operated by the door changes the heating element configuration between grill and oven operation. When the door is open, the top inner element is activated for intense downward heat. When the door is closed, the top outer elements are activated to provide even oven heating.

### Using as a grill

When the door is full open, it remains tilted slightly, so that any spillage will be directly away from you.

1. Opened the drawer.

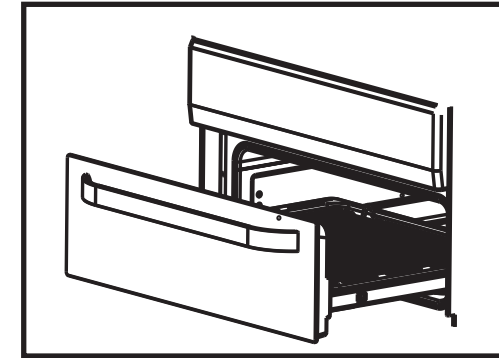

2. Turn the grill on by turning the control knob to maximum temperature position and allow to preheat for around 5 minutes.  
3. The indicator light will glow to show that the grill has been switched on.  
4. Then choose the desired setting.

- Plates and dishes placed on the floor of the grill compartment will be heated when the main oven is in use.
- Do not switch on the grill when using the compartment for storage.
- Do not line the grill pan with aluminium foil.

## OPERATION

### Using as an oven

1. Turn on the oven by rotating the top oven control knob clockwise.
2. Select the temperature in the oven by selecting the temperature (in degrees Celsius) printed on the knob.
3. The amber temperature indicator light on the control panel will glow until the pre-set temperature is reached.
4. Once the temperature has been reached, the amber light will go off and cycle on and off to maintain the pre-set temperature.

Take care when opening the door. Let steam and hot air escape before removing the food.

### Top oven temperature chart

This chart is for guidance only. Follow food manufacturer's recommendations whenever available.

There is a temperature conversion chart in the oven section.

Food	Cooking temperature ° C	Time
Beef	170-180	30 mins per 450g+30 mins
Lamb	180-190	30 mins per 450g+30 mins
Pork	170-190	30 mins per 450g+30 mins
Poultry	170-190	25-30 mins per 450g+25 mins
Fruit cake	140-160	Time dependent on size
Small cakes	160-180	20-25mins
Victoria sandwich	160-180	20-25mins

## OPERATION

### Operating the fan oven

#### Caution!

Do not touch the heating elements or other parts that may become hot when the grill/top oven is in use, children must be kept away.

1. Turn on the oven by rotating the oven control knob clockwise.
2. Select the temperature in the oven by selecting the temperature (in degrees Celsius) printed on the knob.

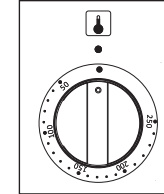

3. The amber temperature indicator light on the control panel will glow until the pre-set temperature is reached.
4. Once the temperature has been reached, the amber light will go off and cycle on and off. Ensure you stand back from the appliance when opening the oven door to allow any build up of steam or heat to escape.

#### Caution!

- Check food is thoroughly cooked and piping hot.
- As a fan oven heats up more quickly and generally cooks food at a lower temperature than a conventional oven, preheating the oven is often unnecessary. However, food such as bread, scones and Yorkshire pudding, do benefit from being placed in a pre-heated oven.

### Temperature conversion

The oven temperature control knob is marked in degrees Celsius (sometimes called centigrade). This chart will help when recipes show °F or use descriptive terms (as recommended by the Association of Manufacturers of Domestic Electrical Appliances).

Description	Celsius °C	Fahrenheit °F
Cool	70	150
	80	175
	100	200
	110	225
Slow	120	250
	140	275
	150	300
Fairly hot	160	325
	180	350
Hot	190	375
	200	400
Very hot	220	425
	230	450
	250	480

Food	Cooking temperature ° C	Time	Shelf position
Beef	160-180	20-25 mins per 450g+20 mins	2
Lamb	160-180	25 mins per 450g+25 mins	2
Pork	160-180	25 mins per 450g+25 mins	1-2
Poultry up to 4Kg(8lbs)	160-180	18-20 mins per 450g+20 mins	1-2
Poultry up to 5.5Kg(12lbs)	150-160	14-16 mins per 450g+20 mins	1-2
Casseroles	140-150	1.5-2 hours dependent on quantity	1-2
Fruit cake	130-140	Time dependent on size	2-3
Small cakes	160-180	20-25mins	4
Victoria sandwich	160-180	20-25mins	1

## OPERATION

### ▷ Oven functions and operation (only for main oven)

The oven is controlled by the function knob, timer knob and the temperature selection knob.

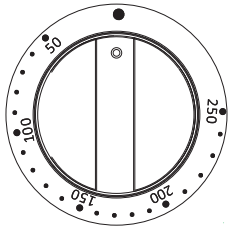

Temperature selection knob

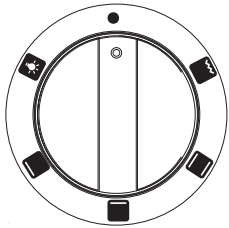

5 Function knob

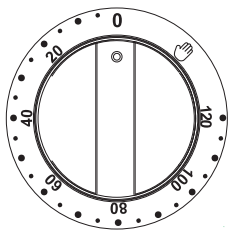

Mechanical timer knob

#### **Caution!**

When selecting any heating function (switching a heater on etc.) the oven will only be switched on after the temperature has been set by the temperature regulator knob.

### ▷ Mechanical timer (Only for main oven)

When using the oven, you must set food cooking time.

1. Turn mechanical timer to the time position you want.



2. Turn function knob to the function position you want.



3. Turn temperature knob to the temperature position you want.



4. After above operation, oven knob runs normally.

5. When oven works till pre-set time, timer will have sound which means the cooking is finished.

If you don't want the oven work controlled by the mechanical timer, you can turn the mechanical timer to the position.



#### **Caution!**

When selecting any oven function, the oven will only be switched on after the temperature has been set by the temperature selection knob.

## OPERATION

### Possible settings of the oven function knob

#### **Caution!**

At this oven function knob position. The oven is not being warmed up.



#### **Classic convection**

(Bottom Heat + Top Heat)

Setting the knob to this position allows the oven to be heated conventionally.



#### **Separate oven lighting**

By setting the knob to this position the lighting inside the oven is switched on



#### **Base Heat**

(Bottom heater)

At this oven function knob position, the oven activates the bottom heater.



#### **Top element**

At this oven function knob position, the oven activates the top element.



#### **Static Grill**

(Double Grill)

When the "combined grill" is active it enables grilling with the grill and with the top heater switched on at the same time.

This function allows a higher temperature at the top of the cooking area, which causes more intense browning of the dish and permits larger portions to be grilled.



## OPERATION

### Use of the grill

The grilling process operates through infrared rays emitted onto the dish by the incandescent grill heater.

In order to switch on the grill you need to:

- Set the oven knob to the position marked grill.
- Heat the oven for approx. 5 minutes (with the oven door shut).
- Insert a tray with a dish onto the appropriate cooking level; and if you are grilling on the grate insert a tray for dripping on the level immediately below (under the grate).
- Close the oven door.

For grilling with the function grill and combined grill the temperature must be set to 250°C, but for the function fan and grill it must be set to a maximum of 200°C.

### Warning!

When using grill function it is recommended that the oven door is closed.

When the grill is in use accessible parts can become hot.

It is best to keep children away from the oven.

### Bottom main Oven guide levels

Baking pans and accessories (oven grid, baking tray, etc) may be inserted into the oven in 5 guiding levels. Appropriate levels are indicated in the tables that follow. Always count levels from the bottom upwards!

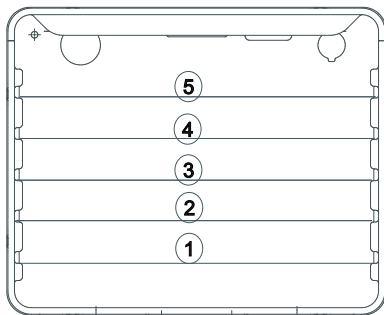

## CLEANING AND MAINTENANCE

By ensuring proper cleaning and maintenance of your oven you can have a significant influence on the continuing fault-free operation of your appliance.

Before you start cleaning, the oven must be switched off and you should ensure that all knobs are set to the "0" position. Do not start cleaning until the oven has completely cooled.

### ▷Oven

- The oven should be cleaned after each use.
- Cool the oven completely before cleaning.
- Never clean the appliance with pressurised hot steam cleaner!
- The oven chamber should only be washed with warm water and a small amount of washing-up liquid.
- **Steam cleaning**
  - pour 250mL of water (1 cup) into a bowl placed in the oven on the first level from the bottom.
  - Close the oven door,
  - Set the temperature knob to 50°C, and the function knob to the bottom heater position,
  - heat the oven chamber for approximately 30 minutes,
  - Open the oven door, wipe the chamber inside with a cloth or sponge and wash using warm water with washing-up liquid.
- After cleaning the oven chamber wipe it dry.

### Caution!

Do not use cleaning products containing abrasive materials for the cleaning and maintenance of the glass front panel.

## CLEANING AND MAINTENANCE

### Turn off at the mains before cleaning.

Before switching on again ensure that all controls are in the off position.

**Make sure that the oven grill and hobs are sufficiently cool before you start cleaning.**

Never mix different cleaning products as different active ingredients may react with unforeseen results.

### Exterior

Use a damp cloth to clean the outside. Never use any sharp instruments, abrasive household cleaner, or detergents for cleaning. For hard stains use suitable washing liquid.

### Control panel

Wipe over the control panel with a damp cloth and polish with a dry cloth. Do not use oven cleaners or aerosols, scouring pads or abrasive powder for cleaning the plastic knobs or end caps as damage will occur. Do not attempt to remove any of the control knobs from the panel as this may cause damage and is a safety hazard.

### Grill interior

Wipe the grill elements with a damp cloth (ensuring they are sufficiently cool first) to remove any fat splashes. This will prevent fumes from any fat being burned off when the cooker is next used.

### Oven interior

Remove the rod shelves for washing in the sink. Use a fine steel wool soap pad for removing stubborn stains from the rod shelves and floor of the oven. Take care during cleaning not to damage, bend or dislodge from the surrounding clips the thermostat sensor which is located at the top right hand side of the oven

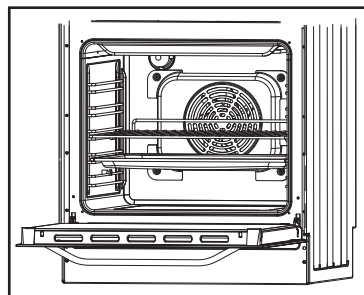

## CLEANING AND MAINTENANCE

**Before any maintenance is started involving electrical parts, the appliance must be disconnected from the power supply. If the oven has been in use, let the oven cavity and the heating elements cool down before attempting any maintenance.**

### Changing the bulb

- Unscrew the protective cover. We recommend that you wash and dry the glass cover at this point.
- Carefully remove the old bulb and insert the new bulb suitable for high temperatures (300°C) having the following specifications: 220-240V, 50Hz, 25W, G9 fitting.
- Refit the protective cover.

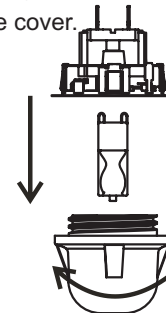

### IMPORTANT

**Never use screwdrivers or other utensils to remove the light cover. This could damage the enamel of the oven or the lampholder. Remove only by hand.**

### IMPORTANT

**Never replace the bulb with bare hands as contamination from your fingers can cause premature failure. Always use a clean cloth or gloves.**

### Please note:

The bulb replacement is not covered by your guarantee

### ▷ Door removal

In order to obtain easier access to the oven chamber for cleaning, it is possible to remove the door.

To do this, tilt the safety catch part of the hinge upwards. Close the door lightly, lift and pull it out towards you. In order to fit the door back on to the cooker, do the reverse. When fitting, ensure that the notch of the hinge is correctly placed on the protrusion of the hinge holder. After the door is fitted to the oven, the safety catch should be carefully lowered down again. If the safety catch is not set it may cause damage to the hinge when closing the door.

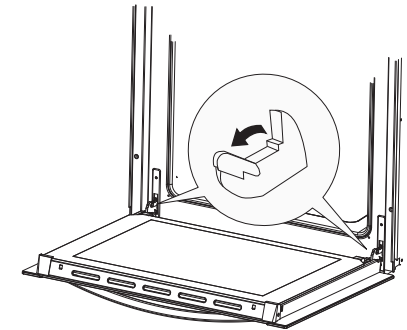

Tilting the hinge safety catches

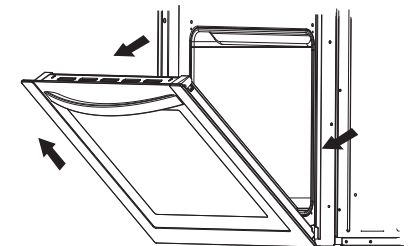

Door removal

## CLEANING AND MAINTENANCE

### ▷ Removal of the internal glass panel

Unscrew and unfasten the plastic latch that is in the corner at the top of the door. Next take out the glass from the second blocking mechanism and remove. After cleaning, insert and block the glass panel, and screw in the blocking mechanism.

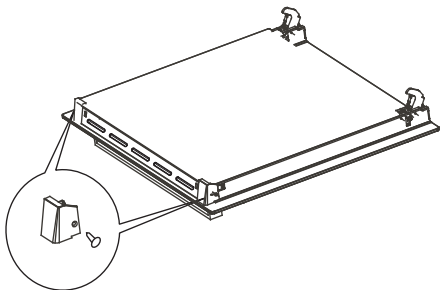

Removal of the internal glass panel

### ▷ Install door

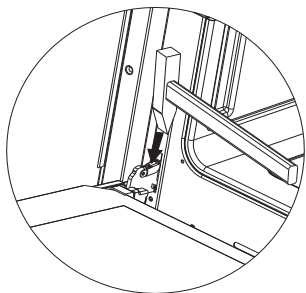

### ▷ Regular inspections

Besides keeping the cooker clean, you should:

- Carry out periodic inspections of the control elements and cooking units of the cooker. After the guarantee has expired you should have a technical inspection of the cooker carried out at a service centre at least once every two years.
- Fix any operational faults.
- Carry out periodical maintenance of the cooking units of the cooker.

#### **Caution!**

All repairs and regulatory activities should be carried out by the appropriate service centre or by an appropriately authorized fitter.

## OPERATION IN CASE OF EMERGENCY

### If the cooker does not work

If the appliance does not operate check whether:

- The power supply is on.
  - The fuse has blown/circuit breaker has tripped/main distribution switch has been turned off.
  - The temperature control has been set correct.
  - The main oven will not light has the clock been set.
  - Check your electric power supply earthing system.
  - This cooker must be earthed in doubt consult a qualified electrician.
- If the appliance is still not operating after the above checks, please refer to section on how to obtain service.

### Performance characteristic when in use

- When using your appliance for the first few times, the odour and/or smoke may be emitted which is normal.
- It is normal for the metal parts to produce noise when in use, this is due to expansion and contraction .
- When in use, steam may be produced which is normal and not a fault of the cooker.
- At the end of cooking session, it is normal to have a momentary puff of steam when the oven door is opened. This should disperse in a few seconds.
- If, whilst cooking, steam produced comes in to contact with cool surface's on the outside of the appliance, it will condense and produce water droplets. This is quite normal and is not a fault.

In the event of an emergency, you should:

- switch off all working units of the oven
- Disconnect the mains plug
- Call the service centre
- Some minor faults can be fixed by referring to the instructions given in the table below. Before calling the customer support centre or the service centre check the following points that are presented in the table.

PROBLEM	REASON	ACTION
1.The appliance does not work.	Break in power supply.	Check the household fuse box; if there is a blown fuse replace it with a new one
2. The oven lighting does not work.	The bulb is loose or damaged.	Tighten up or replace the blown bulb ( see Cleaning and Maintenance )

## TECHNICAL INFORMATION

TYPE	HOR54B5MCW1
Dimensions (height/width/depth) cm	90/54/60
Oven	
Guide levels	5
Top heater(kW)	0.85
Bottom heater(kW)	1.15
Grill heater(kW)	1.1
Oven illumination(W)	25
Function modes	
Oven light(W)	25
Top+bottom heater(kW)	2.0
Top heater(kW)	0.85
Bottom heater(kW)	1.15
Top+bottom heater+fan(kW)	–
Top/grill(kW)	1.95
Fan(W)	–
Fan+Rear heater(kW)	–
Fan+Half grill(kW)	–
Fan+Bottom heater(kW)	–
Temperature	50-250°C
Frequency(Hz)	50
Electrical Input(V)	220-240V/380-415V 3N~50Hz
Top Oven Power(kW)	2.0
Main Oven Power(kW)	2.0
Hotplate power(kW)	5.5
Total connected power(kW)	9.5

Complies with AS/NZS regulations EN 50304, AS/NZS60335-1,AS/NZS60335-2-6 standards.

## ELECTRICAL CONNECTION

### Caution!

All electrical work should be carried out by a suitably qualified and authorized electrician. No alterations or willful changes in the electricity supply should be carried out. The fixing line connected must be equipped with the all-pole disconnection device provided by breakaway the contact under overvoltage category III according to the wiring rules.

### Fitting guidelines

The cooker is manufactured to work with three-phase alternating current (380-415V 3N~50 Hz). The voltage rating of the cooker heating elements is 220-240V. Adapting the cooker to operate with one phase current is possible by appropriate bridging in the connection box according to the connection diagram below. The connection diagram is also found on the cover of the connection box. Remember that the connection wire should match the connection type and the power rating of the cooker.

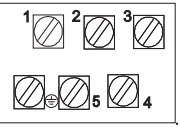
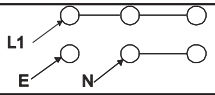
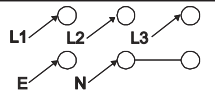
CONNECTION DIAGRAM				Recommended type of connection lead
Caution! Voltage of heating elements 220-240V Caution! In the event of any connection the safety Wire must be connected to the $\oplus$ E terminal.				
1	For 220-240V earthed one-phase connection, bridges connect 1-2-3 terminals and 4-5 terminals, safety wire to $\oplus$ .			H05VV-F3G4
2	For 380-415/220-240V earthed three-phase connection, bridges connect 4-5 terminals, phases in succession 1,2 and 3, earth to $\oplus$ .			H05VV-F5G1,5
L1=R, L2=s, L3=T, N=null terminal, E=safety wire terminal				

The connection cable must be secured in a strain-relief clamp. For the connection leads, the grounding wire must be longer than the other wires.

### Caution!

Remember to connect the safety circuit to the connection box terminal marked with  $\oplus$ . Before connecting the cooker to the power supply it is important to read the information on the data plate and the connection diagram.